

SERIES 100A SWITCHES

TOGGLE SWITCHES - MINIATURE



FEATURES & BENEFITS

- ▶ Variety of switching functions
- ▶ Miniature
- ▶ Multiple actuator & bushing options
- ▶ Sealed to IP67

APPLICATIONS/MARKETS

- ▶ Telecommunications
- ▶ Instrumentation
- ▶ Networking
- ▶ Medical equipment

SPECIFICATIONS

Contact Rating:	Dependent upon contact material
Life Expectancy:	30,000 make-and-break cycles at full load
Contact Resistance:	10 mΩ max. typical initial @ 2-4 VDC 100 mA for both silver and gold plated contacts
Insulation Resistance:	1,000 MΩ min.
Dielectric Strength:	1,000 V RMS @ sea level
Operating Temperature:	-30° C to 85° C

MATERIALS

Case & Bushing:	PBT
Pedestal of Case:	LPC
Actuator:	Brass, chrome plated with internal O-ring seal
Switch Support:	Brass or steel tin plated
Contacts / Terminals:	Silver or gold plated copper alloy

HOW TO ORDER

SERIES	MODEL NO.	ACTUATOR	BUSHING	TERMINATION	CONTACT MATERIAL	SEAL	HARDWARE
100A	□ □ □ □	□ □	□ □	□ □ □ □	□	E	□
	WSP1 WSP2 WSP3 WSP4 WSP5 WDP1 WDP2 WDP3 WDP4 WDP5	T1 T2	B1 B4	M1 M2 M5 M6 M7 VS2 VS3	Q = Silver R = Gold	E = Epoxy Sealed at Base of Terminal	H = Hardware

Example Ordering Number

100A-WDP4-T1-B4-M1-R-E

Specifications subject to change without notice.

SPDT



Model No.	POS 1	POS 2	POS 3
WSP-1	ON	NONE	ON
WSP-2	ON	NONE	(ON)
WSP-3	ON	OFF	ON
WSP-4	(ON)	OFF	(ON)
WSP-5	ON	OFF	(ON)
Term. Comm.	2-3	OPEN	2-1

() = Momentary

DPDT

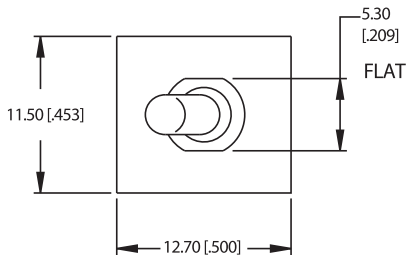
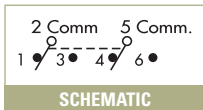

Model No.	POS 1	POS 2	POS 3
WDP-1	ON	NONE	ON
WDP-2	ON	NONE	(ON)
WDP-3	ON	OFF	ON
WDP-4	(ON)	OFF	(ON)
WDP-5	ON	OFF	(ON)
Term. Comm.	2-3, 5-6	OPEN	2-1, 5-4

() = Momentary

ACTUATOR OPTIONS

T1

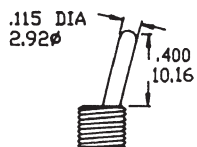

T1 actuator std. when ordered with M1 termination.
Add 0.100 (2.54) for B4 bushing.

T2

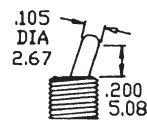

T2 actuator std. when ordered with VS, M2, M6 or M7 terminations.
Add 0.100 (2.54) for B4 bushing.

BUSHING OPTIONS

B1

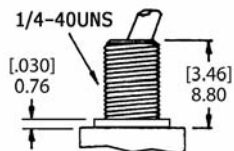

Std for M1

B4

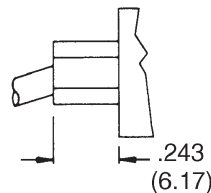

Std for M2, M6, M7, VS termination

SERIES 100A SWITCHES

TOGGLE SWITCHES - MINIATURE

TACT
SWITCHES

NAVIGATION
SWITCHES

PUSHBUTTON
SWITCHES

TOGGLE
SWITCHES

ROCKER
SWITCHES

SLIDE
SWITCHES

SNAP-ACTION
SWITCHES

DIP
SWITCHES

KEYLOCK
SWITCHES

ROTARY
SWITCHES

DETECTOR
SWITCHES

CAP
OPTIONS

TERMINATION OPTIONS

M1

SPDT

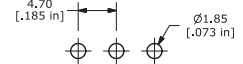
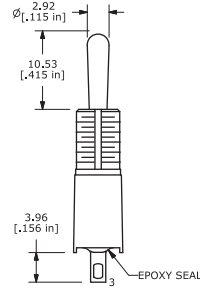
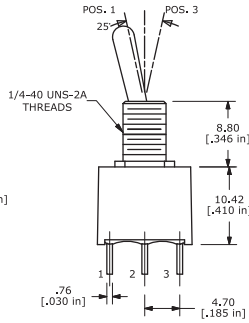
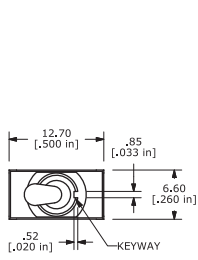

P.C. MOUNTING

M1

DPDT

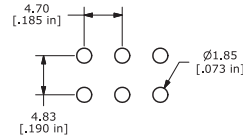
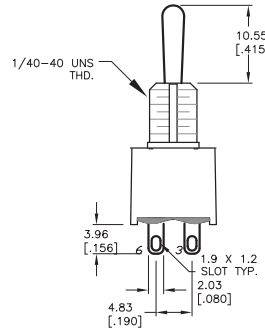
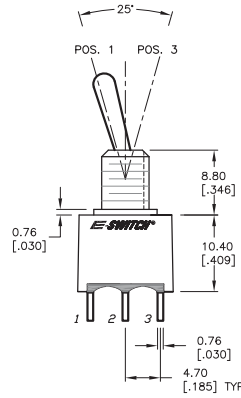
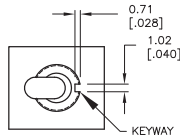

P.C. MOUNTING

M2

SPDT

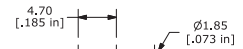
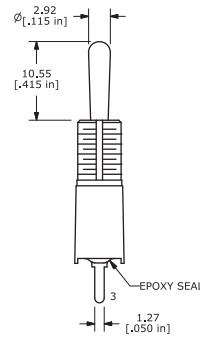
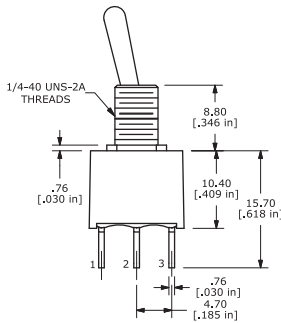
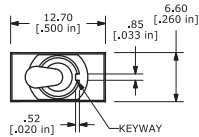

P.C. MOUNTING

M2

DPDT

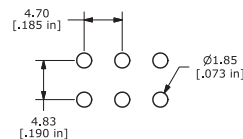
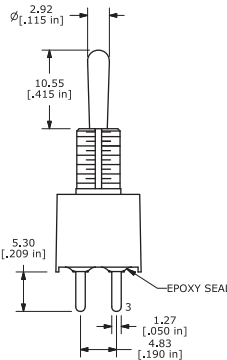
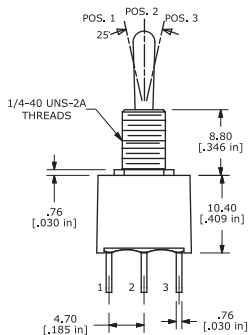
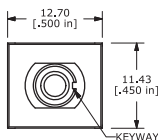

P.C. MOUNTING



M6

SPDT

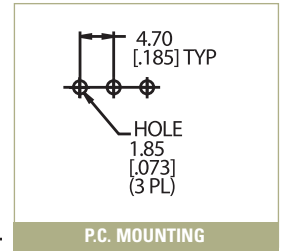
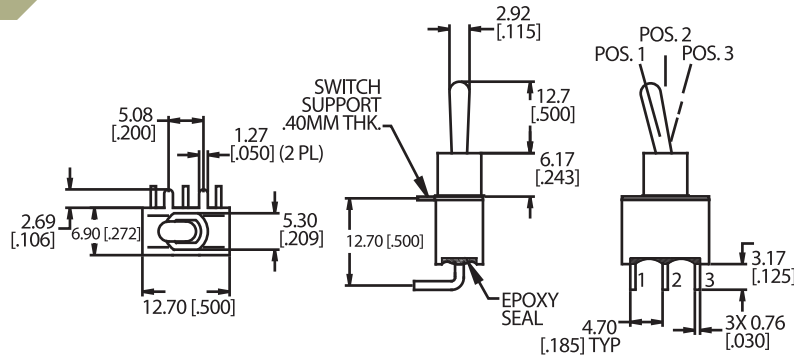

M6

DPDT

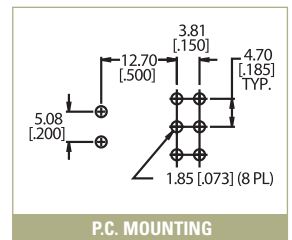
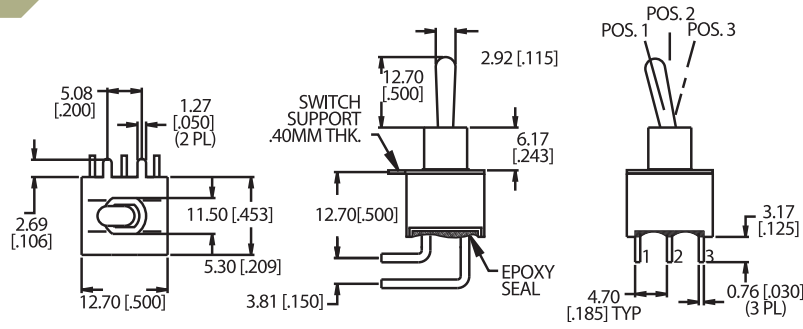
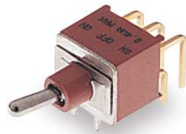

M7

SPDT

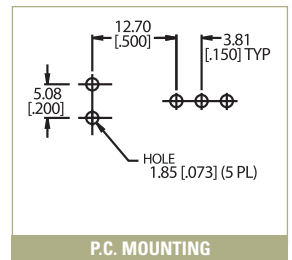
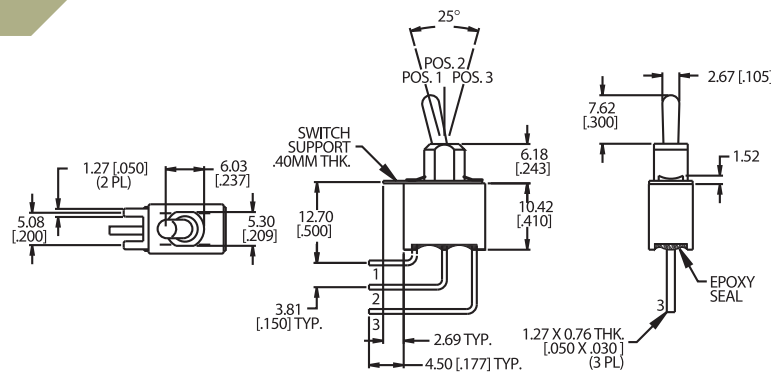
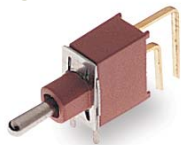

M7

DPDT

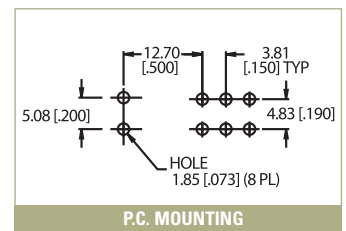
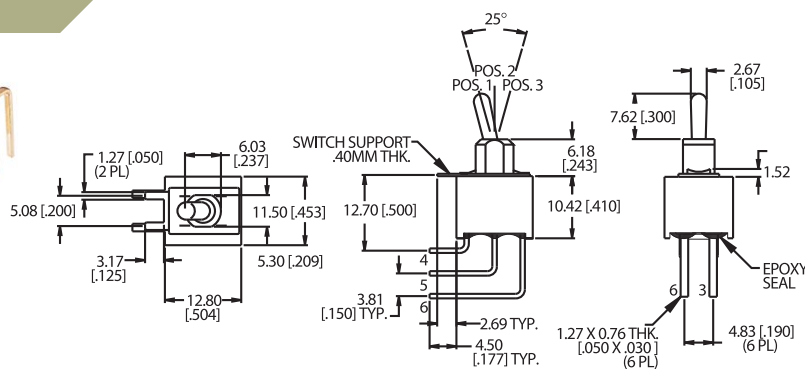

SERIES 100A SWITCHES

TOGGLE SWITCHES - MINIATURE

VS2-VS3

SPDT

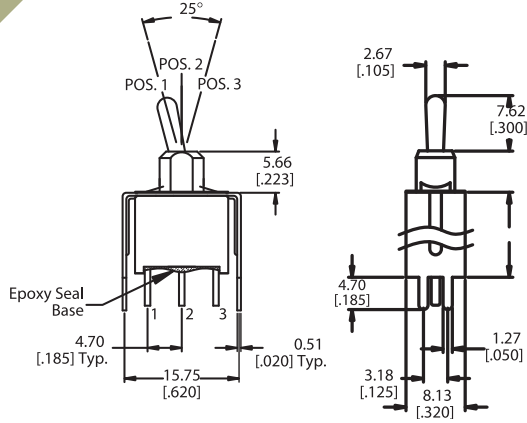

Option Code	Dim. 'A'
VS2	.460 (11.68)
VS3	.630 (16.00)

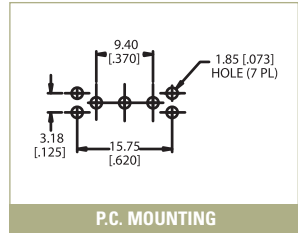

VS2-VS3

DPDT

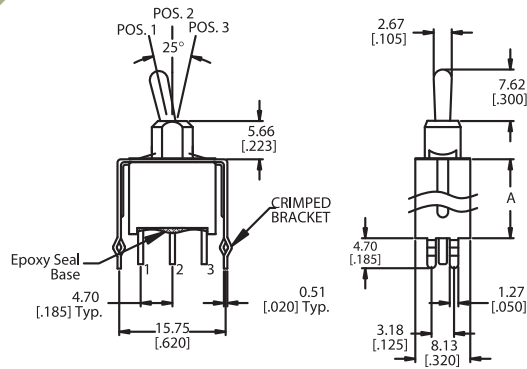

Option Code	Dim. 'A'
VS2	.460 (11.68)
VS3	.630 (16.00)

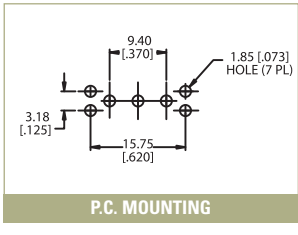

CONTACT MATERIAL OPTIONS

Q

Fixed Terminal:	Gold flash over silver plated copper alloy
Moving Contact:	Silver plated copper alloy
Rating:	5 Amps with resistive load @ 120VAC or 28VDC; 2 Amps with resistive load @ 250VAC

R

Fixed Terminal:	Copper alloy with gold plate over nickel plate
Moving Contact:	Copper alloy with gold plate overnickel plate
Rating:	0.4 Volt-Amps (VA) max. @ 20V max. (AC or DC)

HARDWARE

HDW2 NUT

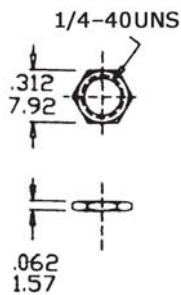

HDW15 LOCKING RING

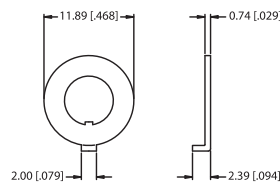

HDW11 LOCK WASHER

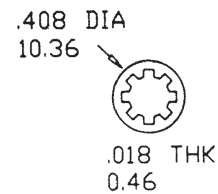

Данный компонент на территории Российской Федерации

Вы можете приобрести в компании MosChip.

Для оперативного оформления запроса Вам необходимо перейти по данной ссылке:

<http://moschip.ru/get-element>

Вы можете разместить у нас заказ для любого Вашего проекта, будь то серийное производство или разработка единичного прибора.

В нашем ассортименте представлены ведущие мировые производители активных и пассивных электронных компонентов.

Нашей специализацией является поставка электронной компонентной базы двойного назначения, продукции таких производителей как XILINX, Intel (ex.ALTERA), Vicor, Microchip, Texas Instruments, Analog Devices, Mini-Circuits, Amphenol, Glenair.

Сотрудничество с глобальными дистрибьюторами электронных компонентов, предоставляет возможность заказывать и получать с международных складов практически любой перечень компонентов в оптимальные для Вас сроки.

На всех этапах разработки и производства наши партнеры могут получить квалифицированную поддержку опытных инженеров.

Система менеджмента качества компании отвечает требованиям в соответствии с ГОСТ Р ИСО 9001, ГОСТ РВ 0015-002 и ЭС РД 009

Офис по работе с юридическими лицами:

105318, г.Москва, ул.Щербаковская д.3, офис 1107, 1118, ДЦ «Щербаковский»

Телефон: +7 495 668-12-70 (многоканальный)

Факс: +7 495 668-12-70 (доб.304)

E-mail: info@moschip.ru

Skype отдела продаж:

moschip.ru

moschip.ru_4

moschip.ru_6

moschip.ru_9