

## 3V SPI Real-Time Clock Calendar with Enhanced Features and Battery Switchover

### Device Selection Table

Part Number	32 kHz Boot-up	SRAM (Bytes)	EEPROM (Kbits)	Unique ID
MCP795W20	No	64	2	Blank
MCP795W10	No	64	1	Blank
MCP795W21	No	64	2	EUI-48™
MCP795W11	No	64	1	EUI-48™
MCP795W22	No	64	2	EUI-64™
MCP795W12	No	64	1	EUI-64™

**Note:** Watchdog Timer and Event Detects in all devices.

### Timekeeping Features:

- Real-Time Clock/Calendar:
  - Hours, Minutes, Seconds, Hundredth of Seconds, Day of Week, Month, Year, Leap Year
- Crystal Oscillator requires External 32,768 kHz Tuning Fork Crystal and Load Capacitors.
- Clock Out Function:
  - 1Hz, 4.096 kHz, 8.192 kHz, 32.768 kHz
- 2 Programmable Alarms – Supports  $\overline{\text{IRQ}}$  or  $\overline{\text{WDO}}$
- Programmable open drain output – Alarm or Interrupt
- On-Chip Digital Trimming/Calibration:
  - +/- 255 PPM range in 1 PPM steps
- Power-Fail Time-Stamp @ Battery Switchover:
  - Logs time when VCC fails and VCC is restored

### Low-Power Features:

- Wide Operating Voltage:
  - VCC: 1.8V to 3.6V
  - VBAT: 1.3V to 3.6V
- Low Operating Current:
  - VCC Standby Current < 1uA @ 3V
  - VBAT Timekeeping Current: <700nA @ 1.8V
- Automatic Battery Switchover from VCC to VBAT:
  - Backup power for timekeeping and SRAM retention

### User Memory:

- 64-Byte Battery-Backed SRAM
- 2 Kbit and 1 Kbit EEPROM Memory:
  - Software block write-protect (1/4, 1/2, or entire array)
  - Write Page mode (up to 8 bytes)
  - Endurance: 1M erase/write cycles
- 128-Bit Unique ID in Protected Area of EEPROM:
  - Available blank or preprogrammed
  - EUI-48™ or EUI-64™ MAC address
  - Unlock sequence for user programming

### Enhanced Features:

- SPI Clock Speed up to 5 MHz
- Programmable Watchdog Timer:
  - Dedicated watchdog output pin
  - Dual retrigger using SPI bus or EVHS digital input
- Dual Configurable Event Detect Inputs:
  - High-Speed Digital Event Detect (EVHS) with pulse count for 1<sup>st</sup>, 4<sup>th</sup>, 16<sup>th</sup> or 32<sup>nd</sup> event
  - Low-Speed Event Detect (EVLS) with programmable debounce delays of 31 msec and 500 msec
  - Edge triggered (rising or falling)
  - Operates from VCC or VBAT
- Operating Temperature Ranges:
  - Industrial (I Temp): -40°C to +85°C.
- Packages include 14-Lead SOIC and TSSOP

### Package Types (not to scale)

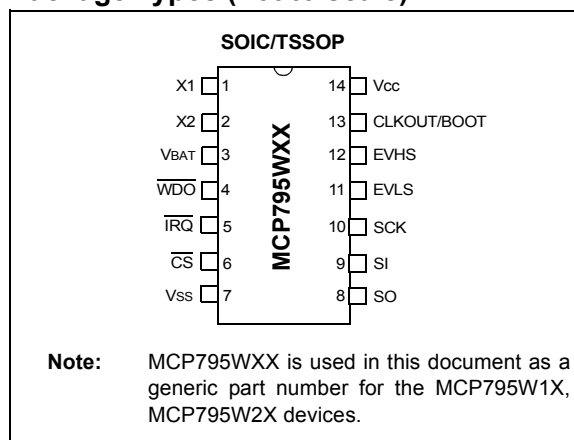

# MCP795W1X/MCP795W2X

## Description:

The MCP795WXX is a low-power Real-Time Clock/Calendar (RTCC) that uses digital trimming compensation for an accurate clock/calendar, an interrupt output to support alarms and events, a power sense circuit that automatically switches to the backup supply, nonvolatile memory for safe data storage and several enhanced features that support system requirements.

Along with a low-cost 32,768 kHz crystal, this RTCC tracks time using several internal registers and then communicates the data over a 5 MHz SPI bus that is fast enough to support a programmable millisecond alarm.

The device is fully accessible through the serial interface, while VCC is between 1.8V and 3.6V, but can operate down to 1.3V through the backup supply connected to the VBAT input for timekeeping and SRAM retention only.

As part of the power sense circuit, a time saver function is implemented to store the time when main power is lost and again, when power is restored to log the duration of a power failure.

Along with the on-board serial EEPROM and battery-backed SRAM, a 128-bit protected space is available for a unique ID. This space can be ordered preprogrammed with a MAC address, or blank for the user to program.

This clock/calendar automatically adjusts for months with fewer than 31 days including corrections for leap years. The clock operates in either 24-hour or 12-hour format with AM/PM indicator and settable alarm(s).

Using the external crystal, the CLKOUT pin can be set to generate a number of output frequencies.

For versatility, a digital event detect with a programmable pulse count can identify the 1<sup>st</sup>, 4<sup>th</sup>, 16<sup>th</sup> or 32<sup>nd</sup> pulse before sending an interrupt. A second event detect with built-in debounce input filter was also implemented to support noisy mechanical switches.

Since many microcontrollers do not have an integrated Watchdog Timer, this peripheral has been implemented in the RTCC. For many applications, this function must be performed outside the microcontroller for increased robustness.

FIGURE 1-1: BLOCK DIAGRAM

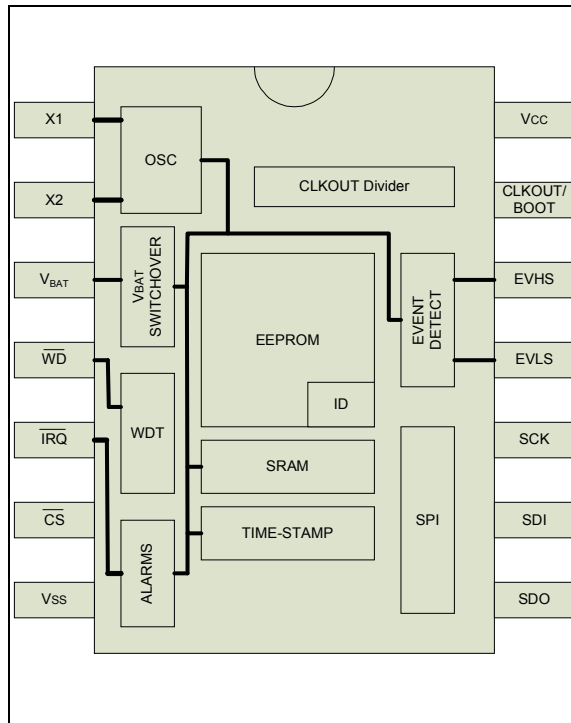

# MCP795W1X/MCP795W2X

## 1.0 ELECTRICAL CHARACTERISTICS

### Absolute Maximum Ratings (†)

V <sub>CC</sub> .....	6.5V
All inputs and outputs w.r.t. V <sub>SS</sub> .....	-0.6V to +6.5V
Storage temperature .....	-65°C to +150°C
Ambient temperature under bias.....	-40°C to +85°C
ESD protection on all pins.....	4 kV

† NOTICE: Stresses above those listed under “Absolute Maximum Ratings” may cause permanent damage to the device. This is a stress rating only and functional operation of the device at those or any other conditions above those indicated in the operational listings of this specification is not implied. Exposure to maximum rating conditions for extended periods may affect device reliability.

**TABLE 1-1: DC CHARACTERISTICS**

DC CHARACTERISTICS			Industrial (I): T <sub>AMB</sub> = -40°C to +85°C V <sub>CC</sub> = 1.8V to 3.6V			
Param. No.	Sym.	Characteristic	Min.	Max.	Units	Test Conditions
D001	V <sub>IH1</sub>	High-level input voltage	.7 V <sub>CC</sub>	V <sub>CC</sub> +1	V	
D002	V <sub>IL1</sub>	Low-level input voltage	-0.3	0.3V <sub>CC</sub>	V	V <sub>CC</sub> ≥ 2.5V
D003	V <sub>IL2</sub>		-0.3	0.2V <sub>CC</sub>	V	V <sub>CC</sub> < 2.5V
D004	V <sub>OL</sub>	Low-level output voltage	—	0.4	V	I <sub>OL</sub> = 2.1 mA
D005	V <sub>OL</sub>		—	0.2	V	I <sub>OL</sub> = 1.0 mA, V <sub>CC</sub> < 2.5V
D006	V <sub>OH</sub>	High-level output voltage	V <sub>CC</sub> -0.5	—	V	I <sub>OH</sub> = -400 μA
D007	I <sub>LI</sub>	Input leakage current		±1	μA	$\overline{CS} = V_{CC}$ , V <sub>IN</sub> = V <sub>SS</sub> TO V <sub>CC</sub>
D008	I <sub>LO</sub>	Output leakage current		±1	μA	$\overline{CS} = V_{CC}$ , V <sub>OUT</sub> = V <sub>SS</sub> TO V <sub>CC</sub>
D009	C <sub>INT</sub>	Internal Capacitance (all inputs and outputs)	—	7	pF	T <sub>AMB</sub> = 25°C, CLK = 1.0 MHz V <sub>CC</sub> = 3.6V ( <b>Note 1</b> )
D010	I <sub>CC</sub> Read	Operating Current	—	3	mA	V <sub>CC</sub> = 3.5V; F <sub>CLK</sub> = 5 MHz SO = Open
D011	I <sub>DD</sub> write	Write Current	—	5	mA	V <sub>CC</sub> = 3.6V
D012	I <sub>BAT</sub>	V <sub>BAT</sub> Current	—	700	nA	V <sub>BAT</sub> = 1.8V @ 25°C ( <b>Note 2</b> )
D013	V <sub>TRIP</sub>	V <sub>BAT</sub> Change Over	1.3	1.7	V	1.5V typical at T <sub>AMB</sub> = 25°C
D014	V <sub>CCFT</sub>	V <sub>CC</sub> Fall Time	300		μs	From V <sub>TRIP</sub> (max) to V <sub>TRIP</sub> (min)
D015	V <sub>CCRT</sub>	V <sub>CC</sub> Rise Time	0		μs	From V <sub>TRIP</sub> (min) to V <sub>TRIP</sub> (max)
D016	V <sub>BAT</sub>	V <sub>BAT</sub> Voltage Range	1.3	3.6	V	—
D017	I <sub>CCS</sub>	Standby Current	—	1	μA	—

**Note 1:** This parameter is periodically sampled and not 100% tested.

**2:** With oscillator running.

# MCP795W1X/MCP795W2X

**TABLE 1-2: AC CHARACTERISTICS**

AC CHARACTERISTICS			Industrial (I): T <sub>AMB</sub> = -40°C to +85°C V <sub>CC</sub> = 1.8V to 3.6V			
Param. No.	Sym.	Characteristic	Min.	Max.	Units	Test Conditions
1	FCLK	Clock Frequency	—	5	MHz	2.5V ≤ V <sub>CC</sub> < 3.6V
			—	3	MHz	1.8V ≤ V <sub>CC</sub> < 2.5V
2	T <sub>CSS</sub>	$\overline{\text{CS}}$ Setup Time	100	—	ns	2.5V ≤ V <sub>CC</sub> < 3.6V
			150	—	ns	1.8V ≤ V <sub>CC</sub> < 2.5V
3	T <sub>CSH</sub>	$\overline{\text{CS}}$ Hold Time	100	—	ns	2.5V ≤ V <sub>CC</sub> < 3.6V
			150	—	ns	1.8V ≤ V <sub>CC</sub> < 2.5V
4	T <sub>CSD</sub>	$\overline{\text{CS}}$ Disable Time	50	—	ns	—
5	T <sub>SU</sub>	Data Setup Time	20	—	ns	2.5V ≤ V <sub>CC</sub> < 3.6V
			30	—	ns	1.8V ≤ V <sub>CC</sub> < 2.5V
6	T <sub>HD</sub>	Data Hold Time	40	—	ns	2.5V ≤ V <sub>CC</sub> < 3.6V
			50	—	ns	1.8V ≤ V <sub>CC</sub> < 2.5V
7	T <sub>R</sub>	CLK Rise Time	—	100	ns	(Note 1)
8	T <sub>F</sub>	CLK Fall Time	—	100	ns	(Note 1)
9	T <sub>HI</sub>	Clock High Time	100	—	ns	2.5V ≤ V <sub>CC</sub> < 3.6V
			150	—	ns	1.8V ≤ V <sub>CC</sub> < 2.5V
10	T <sub>LO</sub>	Clock Low Time	100	—	ns	2.5V ≤ V <sub>CC</sub> < 3.6V
			150	—	ns	1.8V ≤ V <sub>CC</sub> < 2.5V
11	T <sub>CLD</sub>	Clock Delay Time	50	—	ns	—
12	T <sub>CLE</sub>	Clock Enable Time	50	—	ns	—
13	T <sub>V</sub>	Output Valid from Clock Low	—	100	ns	2.5V ≤ V <sub>CC</sub> < 3.6V
			—	160	ns	1.8V ≤ V <sub>CC</sub> < 2.5V
14	T <sub>HO</sub>	Output Hold Time	0	—	ns	(Note 1)
15	T <sub>DIS</sub>	Output Disable Time	—	80	ns	2.5V ≤ V <sub>CC</sub> < 3.6V (Note 1)
			—	160	ns	1.8V ≤ V <sub>CC</sub> < 2.5V (Note 1)
16	T <sub>WC</sub>	Internal Write Cycle Time	—	5	ms	(Note 3)
17	—	Endurance	1,000,000	—	E/W Cycles	(Note 2)

**Note 1:** This parameter is periodically sampled and not 100% tested.

**2:** This parameter is not tested but ensured by characterization. For endurance estimates in a specific application, please consult the Total Endurance™ Model which can be obtained from Microchip's web site: [www.microchip.com](http://www.microchip.com).

**3:** T<sub>WC</sub> begins on the rising edge of  $\overline{\text{CS}}$  after a valid write sequence and ends when the internal write cycle is complete.

# MCP795W1X/MCP795W2X

**FIGURE 1-1: SERIAL INPUT TIMING**

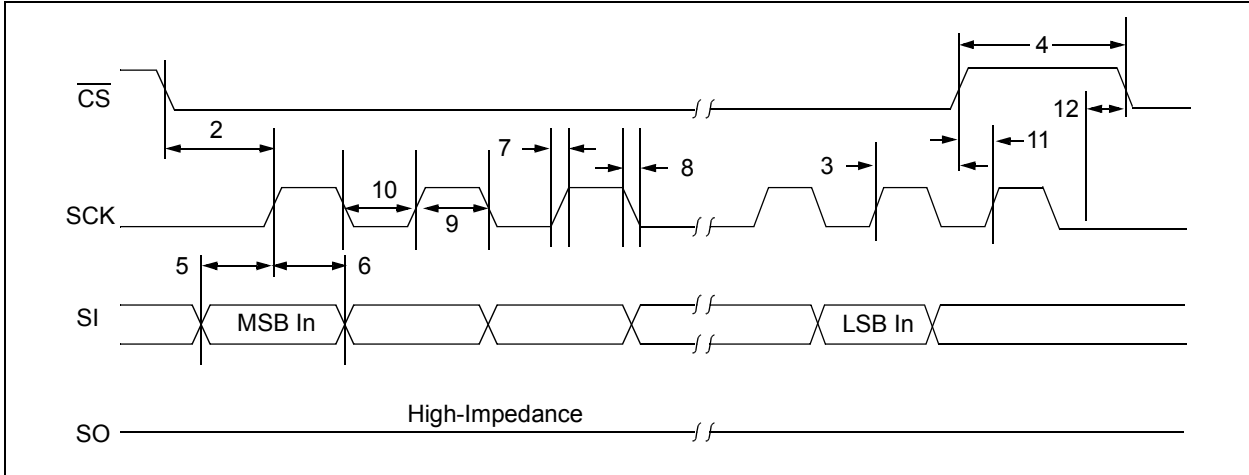

**FIGURE 1-2: SERIAL OUTPUT TIMING**

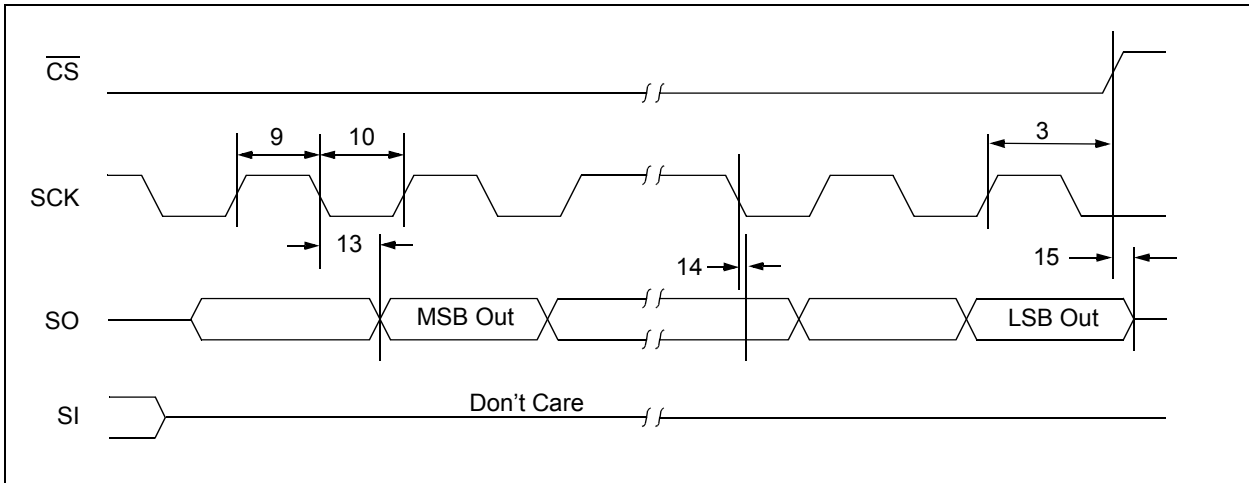

# MCP795W1X/MCP795W2X

## 2.0 PIN DESCRIPTION

The descriptions of the pins are listed in [Table 2-1](#).

**FIGURE 2-1: DEVICE PINOUTS**

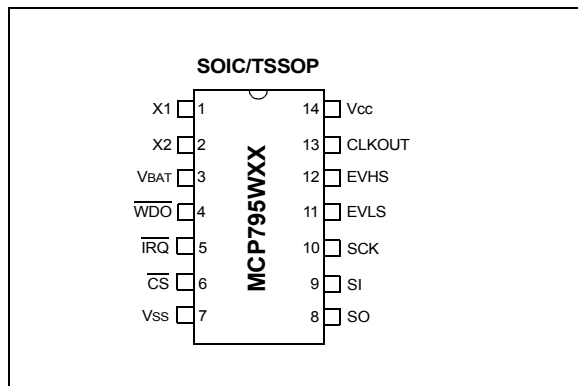

### 2.1 Chip Select ( $\overline{\text{CS}}$ )

A low level on this pin selects the device. A high level deselects the device and forces it into Standby mode. However, a programming cycle which is already initiated or in progress will be completed, regardless of the  $\overline{\text{CS}}$  input signal. If  $\overline{\text{CS}}$  is brought high during a program cycle, the device will go in Standby mode as soon as the programming cycle is complete. When the device is deselected, SO goes into the high-impedance state, allowing multiple parts to share the same SPI bus. A low-to-high transition on  $\overline{\text{CS}}$  after a valid write sequence initiates an internal write cycle. After power-up, a low level on  $\overline{\text{CS}}$  is required prior to any sequence being initiated.

### 2.2 Serial Output (SO)

The SO pin is used to transfer data out of the MCP795WXX. During a read cycle, data is shifted out on this pin after the falling edge of the serial clock.

### 2.3 Watchdog Output ( $\overline{\text{WDO}}$ )

This pin is a hardware open drain from the internal watchdog circuit. This pin requires an external pull-up to VCC. When a watchdog overflow occurs the on-board N-Channel will pulse this pin low. The pulse duration is user selectable (Address 0x0A:4). This pin has a maximum sink current of 10mA.

### 2.4 Serial Input (SI)

The SI pin is used to transfer data into the device. It receives instructions, addresses and data. Data is latched on the rising edge of the serial clock.

### 2.5 Serial Clock (SCK)

The SCK is used to synchronize the communication between a master and the MCP795WXX. Instructions, addresses or data present on the SI pin are latched on the rising edge of the clock input, while data on the SO pin is updated after the falling edge of the clock input.

### 2.6 Interrupt Output ( $\overline{\text{IRQ}}$ )

The  $\overline{\text{IRQ}}$  pin is shared with the on-board event detect and the alarms. This pin requires an external pull-up to VCC or VBAT. The on-board N-Channel will pull the pin low during an event detection or an alarm. The pin remains low until such time that the interrupt flag in the register is cleared by software. This pin has a maximum sink current of 10mA.

### 2.7 X1, X2

The X1 and X2 pins connect to the on-board oscillator block. X1 is the input to the module and X2 is the output of the module. The device can be run from an external CMOS signal by feeding into the X1 pin. If driving X1 the X2 pin should be a No Connect.

### 2.8 VBAT

The VBAT pin is a secondary supply input to maintain the Clock and SRAM contents when VCC is removed.

### 2.9 CLKOUT

The CLKOUT is a push-pull output that can be used to generate a squarewave. Please refer to [Section 9.1.2, Clockout Function](#) for more details.

### 2.10 EVHS and EVLS

The EVHS and EVLS are inputs for the High and Low Speed Event Detection circuit.

**TABLE 2-1: PIN DESCRIPTIONS**

Pin Name	Pin Function
Vss	Ground
X1	Xtal Input, External Oscillator Input
X2	Xtal Output
VBAT	Battery Backup Input (3V Typ)
VCC	+1.8V to +3.6V Power Supply
SI	Serial Input
$\overline{\text{WDO}}$	Watchdog Output
SCK	Serial Clock
CLKOUT	Clock Out
$\overline{\text{CS}}$	Chip Select
$\overline{\text{IRQ}}$	Interrupt Output
EVHS	High-Speed Event Detect Input
EVLS	Low-Speed Event Detect Input
SO	Serial Output

## 2.11 RTCC Memory Map

The RTCC registers are contained in addresses 0x00h-0x1fh. 64 bytes of user-accessable SRAM are located in the address range 0x20-0x5f. The SRAM memory is a separate block from the RTCC control and Configuration registers. All SRAM locations are battery-backed-up during a VCC power fail. Unused locations are not accessible.

- Addresses 0x00h-0x07h are the RTCC Time and Date registers. These are read/write registers. Care must be taken when writing to these registers with the oscillator running.
- Incorrect data can appear in the Time and Date registers if a write is attempted during the time frame where these internal registers are being incremented. The user can minimize the likelihood of data corruption by ensuring that any writes to the Time and Date registers occur before the contents of the second register reach a value of 0x59H.

- Addresses 0x08h-0x0Bh are the device Configuration, Calibration, Watchdog Configuration and Event Detect Configuration registers.
- Addresses 0x0ch-0x11h are the Alarm 0 registers. These are used to set up the Alarm 0, the interrupt pin and the Alarm 0 compare.
- Addresses 0x12h-0x17h are the Alarm 1 registers. These are used to set up the Alarm 1, the interrupt pin and the Alarm 1 compare, Alarm 1 offers a enhanced resolution of tenth and hundredths of seconds.
- Addresses 0x18h-0x1Fh are used for the power-down and power-up time-stamp feature. The detailed memory map is shown in [Table 4-1](#). No error checking is provided when loading Time and Date registers.

**FIGURE 2-2: MEMORY MAP**

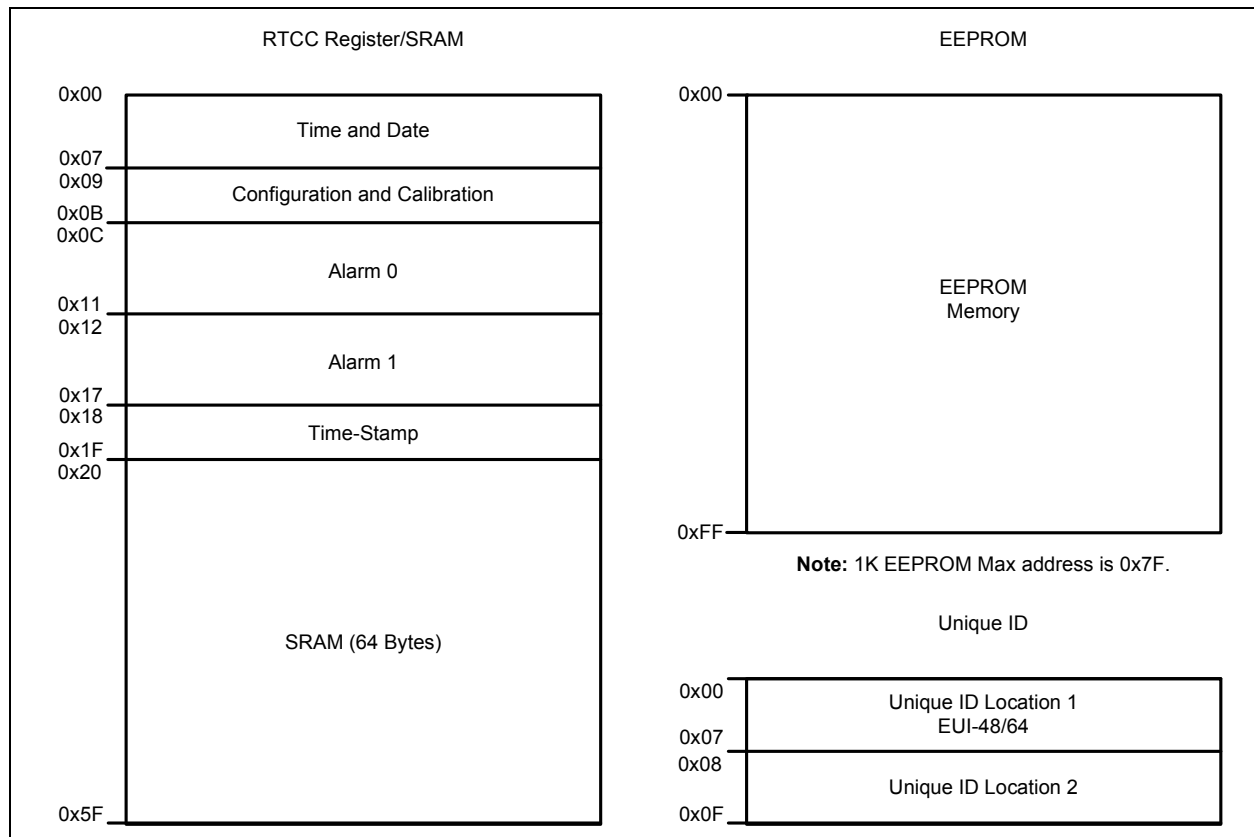

# MCP795W1X/MCP795W2X

## 3.0 SPI BUS OPERATION

The MCP795WXX is designed to interface directly with the Serial Peripheral Interface (SPI) port of many of today's popular microcontroller families, including Microchip's PIC® microcontrollers. It may also interface with microcontrollers that do not have a built-in SPI port by using discrete I/O lines programmed properly in software to match the SPI protocol.

The MCP795WXX contains an 8-bit instruction register.

The device is accessed via the SI pin, with data being clocked in on the rising edge of SCK. The CS pin must be low for the entire operation.

Table 3-1 contains a list of the possible instruction bytes and format for device operation. All instructions, addresses, and data are transferred MSb first, LSb last.

Data (SI) is sampled on the first rising edge of SCK after CS goes low.

**TABLE 3-1: INSTRUCTION SET SUMMARY**

Instruction Name	Instruction Format	Description
EEREAD	0000 0011	Read data from EE memory array beginning at selected address
EEWRITE	0000 0010	Write data to EE memory array beginning at selected address
EEWRDI	0000 0100	Reset the write enable latch (disable write operations)
EEWREN	0000 0110	Set the write enable latch (enable write operations)
SRREAD	0000 0101	Read STATUS register
SRWRITE	0000 0001	Write STATUS register
READ	0001 0011	Read RTCC/SRAM array beginning at selected address
WRITE	0001 0010	Write RTCC/SRAM data to memory array beginning at selected address
UNLOCK	0001 0100	Unlock ID Locations
IDWRITE	0011 0010	Write to the ID Locations
IDREAD	0011 0011	Read the ID Locations
CLRWDT	0100 0100	Clear Watchdog Timer
CLRDRAM	0101 0100	Clear RAM Location to '0'

## 3.1 Read Sequence

The device is selected by pulling CS low. The various 8-bit read instructions are transmitted to the MCP795WXX followed by an 8-bit address. See Figure 3-1 for more details.

After the correct instruction and address are sent, the data stored in the memory at the selected address is shifted out on the SO pin. Data stored in the memory at

the next address can be read sequentially by continuing to provide clock pulses to the slave. The internal Address Pointer automatically increments to the next higher address after each byte of data is shifted out. When the highest address is reached, the address counter rolls over to the first valid address allowing the read cycle to be continued indefinitely. The read operation is terminated by raising the CS pin (Figure 1-1).

**FIGURE 3-1: EEREAD SEQUENCE**

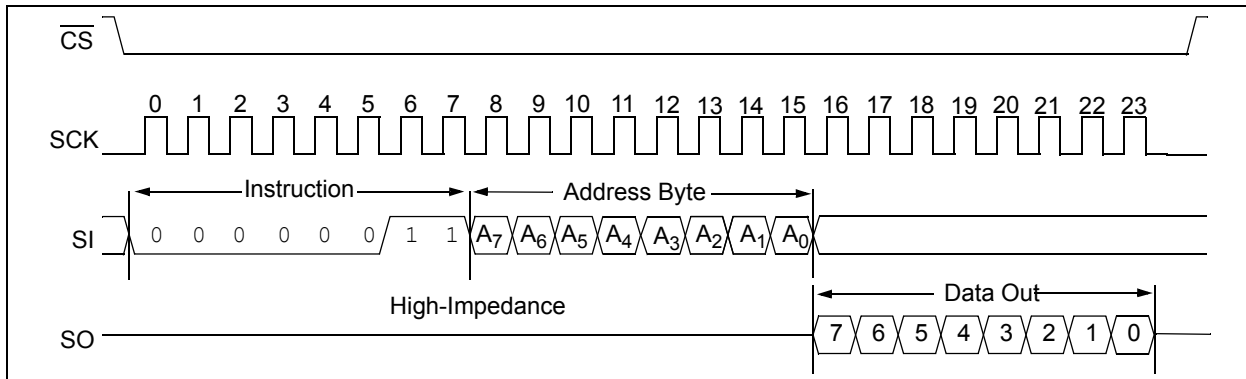



## 3.2 Nonvolatile Memory Write Sequence

Prior to any attempt to write data to the nonvolatile memory (EEPROM, Unique ID and STATUS register) in the MCP795WXX, the write enable latch must be set by issuing the `EEWREN` instruction (Figure 3-4). This is done by setting  $\overline{CS}$  low and then clocking out the proper instruction into the MCP795WXX. After all eight bits of the instruction are transmitted,  $\overline{CS}$  must be driven high to set the write enable latch. If the write operation is initiated immediately after the `EEWREN` instruction without  $\overline{CS}$  driven high, data will not be written to the array since the write enable latch was not properly set.

After setting the write enable latch, the user may proceed by driving  $\overline{CS}$  low, issuing either an `EEWRITE`, `IDWRITE` or a `SRWRITE` instruction, followed by the remainder of the address, and then the data to be written. Up to eight bytes of data can be sent to the device before a write cycle is necessary. The only restriction is that all of the bytes must reside in the same page.

Additionally, a page address begins with `XXXX 0000` and ends with `XXXX X111`. If the internal address counter reaches `XXXX X111` and clock signals continue to be applied to the chip, the address counter will roll back to the first address of the page and overwrite any data that previously existed in those locations.

For the data to be actually written to the array, the  $\overline{CS}$  must be brought high after the Least Significant bit (D0) of the nth data byte has been clocked in. If  $\overline{CS}$  is driven high at any other time, the write operation will not be completed. Refer to Figure 3-2 and Figure 3-3 for more detailed illustrations on the byte write sequence and the page write sequence, respectively. While the nonvolatile memory write is in progress, the STATUS register may be read to check the status of the WIP, WEL, BP1 and BP0 bits. Attempting to read a memory array location will not be possible during a write cycle. Polling the WIP bit in the STATUS register is recommended in order to determine if a write cycle is in progress. When the nonvolatile memory write cycle is completed, the write enable latch is reset.

**FIGURE 3-2: BYTE EEWRITE SEQUENCE**

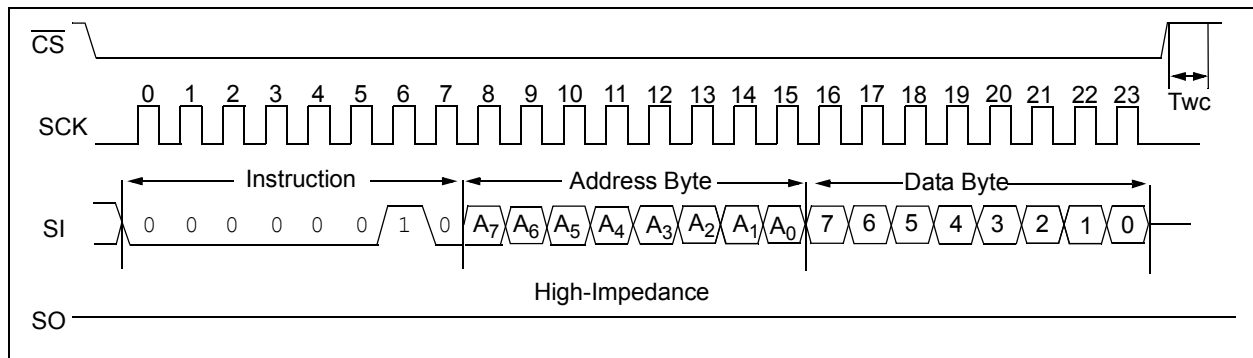

**FIGURE 3-3: PAGE EEWRITE SEQUENCE**

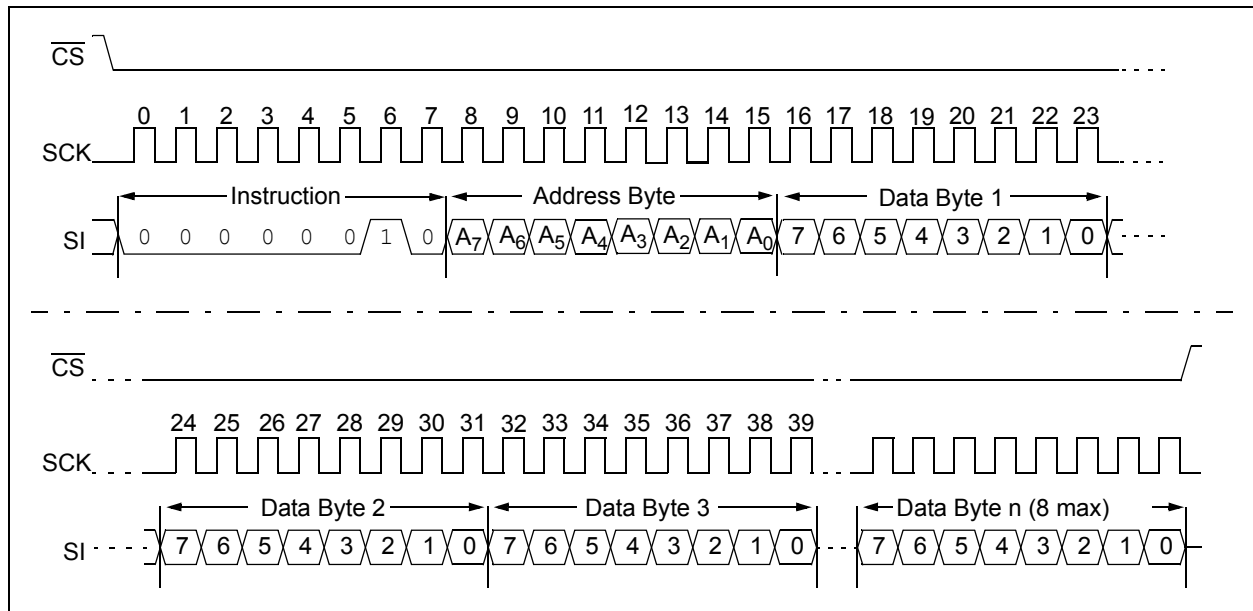

# MCP795W1X/MCP795W2X

## 3.3 Write Enable (EEWREN) and Write Disable (EEWRDI)

The MCP795WXX contains a write enable latch.

This latch must be set before any EEWRITE, SRWRITE and IDWRITE operation will be completed internally. The EEWREN instruction will set the latch, and the EEWRDI will reset the latch.

The following is a list of conditions under which the write enable latch will be reset:

- Power-up
- EEWRDI instruction successfully executed
- SRWRITE instruction successfully executed
- EEWWRITE instruction successfully executed
- IDWRITE instruction successfully executed

**FIGURE 3-4: WRITE ENABLE SEQUENCE (EEWREN)**

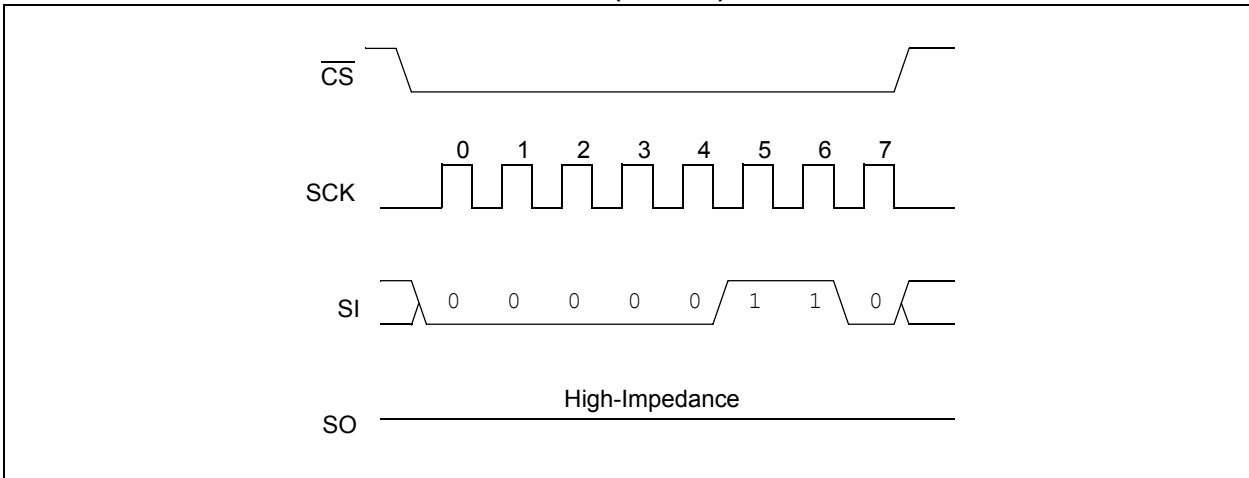

**FIGURE 3-5: WRITE DISABLE SEQUENCE (EEWRDI)**

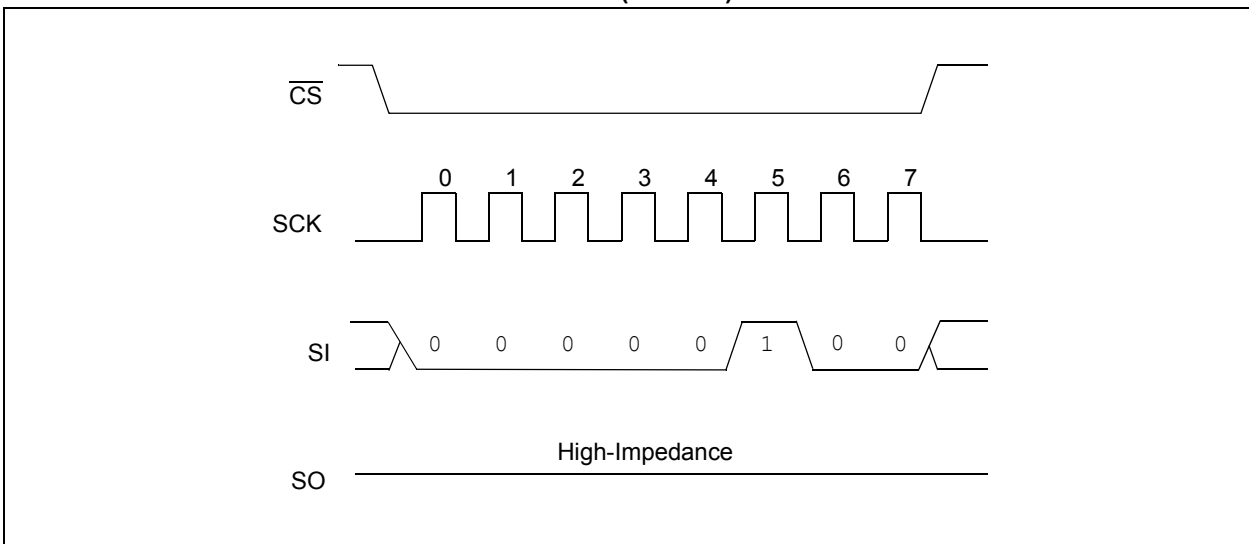

# MCP795W1X/MCP795W2X

## 4.0 RTCC FUNCTIONALITY

### 4.0.1 RTCC REGISTER MAP

The RTCC register space runs from 0x00 through to 0x1F. Any read or write that is started within the RTCC register address space will wrap to the beginning of the RTCC registers.

All of the RTCC registers are backed up from the VBAT supply when VCC is not available, provided that the VBATEN bit is set. Any unused bits or non implemented addresses read back as '0'. No error checking is provided for any of the RTCC, the user may load any value.

The RTCC register map is shown in [Table 4-1](#).

**TABLE 4-1: RTCC REGISTER MAP**

Address	BIT 7	BIT 6	BIT 5	BIT 4	BIT 3	BIT 2	BIT 1	BIT 0	FUNCTION	RANGE	
Time and Configuration Registers											
00h	Tenth Seconds				Hundredths of Seconds				Hundredths of seconds	00-99	
01h	ST (CT)	10 Seconds				Seconds				Seconds	00-59
02h		10 Minutes				Minutes				Minutes	00-59
03h	CALSGN	12/24	10 Hour AM/PM	10 Hour	Hour				Hours	1-12 + AM/PM 00 - 23	
04h			OSCON	VBAT	VBATEN	Day			Day	1-7	
05h			10 Date		Date				Date	01-31	
06h			LP	10 Month	Month				Month	01-12	
07h	10 Year				Year				Year	00-99	
08h	OUT	SQWE	ALM1	ALM0	EXTOSC	RS2	RS1	RS0	Control Reg.		
09h	CALIBRATION								Calibration		
0Ah	WDTEN	WDTIF	WDDEL	WDTPLS	WD3	WD2	WD1	WD0	Watchdog		
0Bh	EVHIF	EVLIF	EVEN1	EVEN0	EVWDT	EVLDB	EVHS1	EVHS0	Event Detect		
Alarm 0 Registers											
0Ch		10 Seconds				Seconds				Seconds	00-59
0Dh		10 Minutes				Minutes				Minutes	00-59
0Eh		12/24	10 Hour AM/PM	10 Hours	Hour				Hours	1-12 + AM/PM 00-23	
0Fh	ALM0PIN	ALM0C2	ALM0C1	ALM0C0	ALM0IF	Day			Day	1-7	
10h		10 Date				Date				Date	01-31
11h		10 Month				Month				Month	01-12
Alarm 1 Registers											
12h		Tenth Seconds				Hundredths of seconds				Hundredths of Seconds	00-99
13h		10 Seconds				Seconds				Seconds	00-59
14h		10 Minutes				Minutes				Minutes	00-59
15h		12/24	10 Hour AM/PM	10 Hours	Hour				Hours	1-12 + AM/PM 00-23	
16h	ALM1PIN	ALM1C2	ALM1C1	ALM1C0	ALM1IF	Day			Day	1-7	
17h		10 Date				Date				Date	01-31
Power-Down Time-Stamp Registers											
18h		10 Minutes				Minutes					
19h		12/24	10 Hour AM/PM	10 Hours	Hour						
1Ah		10 Date				Date					
1Bh		Day				Month					
Power-Up Time-Stamp Registers											
1Ch		10 Minutes				Minutes					
1Dh		12/24	10 Hour AM/PM	10 Hours	Hour						
1Eh		10 Date				Date					
1Fh		Day				Month					

# MCP795W1X/MCP795W2X

## 5.0 TIME AND CONFIGURATION REGISTERS

### REGISTER 5-1: HUNDREDTHS OF SECONDS 0x00

R/W		R/W	
Tenth Seconds		Hundredths of Seconds	
bit 7	bit 4	bit 3	bit 0

**Legend:**

R = Readable bit                      W = Writable bit                      U = Unimplemented bit, read as '0'

bit 7-4            **TENTH SECONDS<3:0>**: Tenth Seconds

bit 3-0            **HUNDREDTHS OF SECONDS<3:0>**: Hundredths of Seconds

**Note 1:** Contains the BCD Tens and Hundredths of Seconds.

### REGISTER 5-2: SECONDS 0x01

R/W		R/W		R/W	
ST		10 Seconds		Seconds	
bit 7	bit 6	bit 4	bit 3	bit 0	

**Legend:**

R = Readable bit                      W = Writable bit                      U = Unimplemented bit, read as '0'

bit 7            **ST**: Start Oscillator bit

ST is the oscillator Start bit. Setting this bit to '1' starts the oscillator and clearing this bit to '0' stops the on-board oscillator.

bit 6-4            **10 SECONDS<2:0>**: 10 Seconds

bit 3-0            **SECONDS<3:0>**: Seconds

**Note 1:** Contains the BCD seconds and 10 seconds. The range is 00 to 59.

### REGISTER 5-3: MINUTES 0x02

U-0		R/W		R/W	
—		10 Minutes		Minutes	
bit 7	bit 6	bit 4	bit 3	bit 0	

**Legend:**

R = Readable bit                      W = Writable bit                      U = Unimplemented bit, read as '0'

bit 7            **Unimplemented**: Read as '0'

bit 6-4            **10 MINUTES<2:0>**: 10 Minutes

bit 3-0            **MINUTES<3:0>**: Minutes

**Note 1:** Contains the BCD minutes and 10 minutes. The range is 00 to 59.

# MCP795W1X/MCP795W2X

## REGISTER 5-4: HOUR 0x03

R/W	R/W	R/W	R/W	R/W
CALSGN	12/24	10 Hour AM/PM	10 Hour	Hour
bit 7	bit 6	bit 5	bit 4	bit 3
				bit 0

### Legend:

R = Readable bit                      W = Writable bit                      U = Unimplemented bit, read as '0'

- bit 7                      **CALSGN:** Calibration Sign bit  
 Bit 7 is the sign bit (CALSGN) for the calibration. Clearing this bit produces a positive calibration, setting this bit produces a negative calibration.
- bit 6                      **12/24:** Clearing this bit to '0' enables 24-hour format, setting this bit to '1' enables 12-hour format.
- bit 5                      **10 HOUR:** AM/PM bit for 12-hour time
- bit 4                      **10 HOUR**
- bit 3-0                      **HOUR<3:0>**

**Note 1:** Contains the BCD hour in bits <3:0>. Bits <5:4> contain either the 10-hour in BCD for 24-hour format or the AM/PM indicator and the 10-hour bit for 12-hour format. Bit 5 determines the hour format.

## REGISTER 5-5: DAY 0x04

U-0	U-0	R	R/W	R/W	R/W
—	—	OSCON	VBAT	VBATEN	Day
bit 7	bit 6	bit 5	bit 4	bit 3	bit 2
					bit 0

### Legend:

R = Readable bit                      W = Writable bit                      U = Unimplemented bit, read as '0'

- bit 7-6                      **Unimplemented:** Read as '0'
- bit 5                      **OSCON:** Oscillator On bit  
 This bit is set and cleared by hardware. If this bit is set, the oscillator is running; if clear, the oscillator is not running. This bit does not indicate that the oscillator is running at the correct frequency. The bit will wait 32 oscillator cycles before the bit is set.
- bit 4                      **VBAT:** External Battery Switched Flag bit  
 This bit is set by hardware when the VCC fails and the VBAT is used to power the oscillator and the RTCC registers. This bit is cleared by software.
- bit 3                      **VBATEN:** External Battery Enable bit  
 If this bit is set the internal circuitry is connected to the VBAT pin. If this bit is '0' then the VBAT pin is disconnected and the only current drain on the external battery is the VBAT pin leakage.
- bit 2-0                      **DAY<2:0>**

**Note 1:** Contains the BCD day. The range is 1-7. Also, additional bits are used for configuration and status.

# MCP795W1X/MCP795W2X

## REGISTER 5-6: DATE 0x05

U-0	U-0	R/W		R/W
—	—	10 Date		Date
bit 7	bit 6	bit 5	bit 4	bit 3
				bit 0

### Legend:

R = Readable bit                      W = Writable bit                      U = Unimplemented bit, read as '0'

bit 7-6                      **Unimplemented:** Read as '0'

bit 5-4                      **10 DATE<1:0>**

bit 3-0                      **DATE<3:0>**

**Note 1:** Contains the BCD Date and 10 Date. The range is 01-31.

## REGISTER 5-7: MONTH 0x06

U-0	U-0	R	R/W	R/W
—	—	LP	10 Month	Month
bit 7	bit 6	bit 5	bit 4	bit 3
				bit 0

### Legend:

R = Readable bit                      W = Writable bit                      U = Unimplemented bit, read as '0'

bit 7-6                      **Unimplemented:** Read as '0'

bit 5                      **LP:** Leap Year, set during a leap year and is read-only

bit 4                      **10 MONTH**

bit 3-0                      **MONTH<3:0>**

**Note 1:** Contains the BCD month. Bit 4 contains the 10 month.

## REGISTER 5-8: YEAR 0x07

R/W		R/W
10 Year		Year
bit 7	bit 4	bit 3
		bit 0

### Legend:

R = Readable bit                      W = Writable bit                      U = Unimplemented bit, read as '0'

bit 7-4                      **10 YEAR<3:0>**

bit 3-0                      **YEAR<3:0>**

**Note 1:** Contains the BCD Year and 10 Year. The Range is 00-99.

# MCP795W1X/MCP795W2X

## REGISTER 5-9: CONTROL REG 0x08

R/W	R/W	R/W	R/W	R/W	R/W	R/W	R/W
OUT	SQWE	ALM1	ALM0	EXTOSC	RS2	RS1	RS0
bit 7	bit 6	bit 5	bit 4	bit 3	bit 2	bit 1	bit 0

### Legend:

R = Readable bit

W = Writable bit

U = Unimplemented bit, read as '0'

- bit 7      **OUT:** Output Polarity of MFP bit  
This bit sets the logic level on the CLKOUT when not using this as a square wave output.
- bit 6      **SQWE:** Squarewave Enable bit  
Setting this bit enables the divided output from the crystal oscillator.
- bit 5-4    **ALM<1:0>:** Alarm Configuration bits  
These bits determine which alarms are active
- 00 – No Alarms are active
  - 01 – Alarm 0 is active
  - 10 – Alarm 1 is active
  - 11 – Both Alarms are active
- bit 3      **EXTOSC:** External Oscillator Input bit  
Enable bit. Setting this bit will allow an external 32.768 kHz signal to drive the RTCC registers, eliminating the need for an external crystal.
- bit 2-0    **RS<2:0>:** Calibration Mode bits  
Sets the internal divider for the 32.768 kHz oscillator to be driven to the CLKOUT. The following frequencies are available. The output is responsive to the Calibration register.
- 000 – 1 Hz
  - 001 – 4.096 kHz
  - 010 – 8.192 kHz
  - 011 – 32.768 kHz
  - 1XX – enables the Cal output function. Cal output appears on CLKOUT if SQWE is set (1 Hz nominal).

**Note 1:** When RS2 is set to enable the Cal output function, the RTCC counters will continue to increment.

## REGISTER 5-10: CALIBRATION 0x09

R/W	
CALIBRATION	
bit 7	bit 0

### Legend:

R = Readable bit

W = Writable bit

U = Unimplemented bit, read as '0'

- bit 7-0    **CALIBRATION VALUE<7:0>:** Calibration Value bits

**Note 1:** This is an 8-bit register that is used to add or subtract clocks from the RTCC counter every minute. The CALSGN (0x03:7) is the sign bit and indicates if the count should be added or subtracted. The eight bits in the Calibration register, with each bit adding or subtracting two clocks, gives the user the ability to add or subtract up to 510 clocks per minute.

# MCP795W1X/MCP795W2X

## REGISTER 5-11: WATCHDOG 0x0A

R/W	R/W	R/W	R/W	R/W	R/W	R/W	R/W
WDTEN	WDTIF	WDDEL	WDTPLS	WD3	WD2	WD1	WD0
bit 7	bit 6	bit 5	bit 4	bit 3	bit 2	bit 1	bit 0

### Legend:

R = Readable bit

W = Writable bit

U = Unimplemented bit, read as '0'

- bit 7      **WDTEN:** Watchdog Timer Enable bit  
This bit is a read/write bit that is set by the user and can be cleared by the user of the hardware. This bit is set to enable the WDT function and cleared to disable the function. This bit is cleared by the hardware when the Vcc supply is not present, it is not set again when Vcc is present.
- bit 6      **WDTIF:** Watchdog Timer Interrupt Flag bit  
This bit is a read/write bit that is set in hardware when the WDT times out and the WD pin is asserted. This bit must be cleared in software to restart the WDT.
- bit 5      **WDDEL:** Watchdog Timer Delay bit  
This bit is a read/write bit and is set to enable a 64-second delay before the WDT starts to count. If this bit is set and the WDTIF bit is cleared then there will be a 64 second delay before the WDT starts to count. This bit should be set before the WDTEN bit is set.
- bit 4      **WDTPLS:** Watchdog Timer Reset Pulse Width bit  
A read/write bit that is used to select the pulse width on the WD pin when the WDT times out.  
- 0 – 122 us Pulse  
- 1 – 125 ms Pulse
- bit 3-0    **WD<3:0>:** Watchdog Timer Configuration bits  
Read/write bits that are used to set the WDT time-out period as below (all times are based off the uncalibrated crystal reference). Bit 3 should be cleared and is reserved for future use:  
- 000 – 977 us  
- 001 – 15.6 ms  
- 010 – 62.5 ms  
- 011 – 125 ms  
- 100 – 1s  
- 101 – 16s  
- 110 – 32s  
- 111 – 64s

**Note 1:** Please see [Section 9.1.3, Watchdog Timer](#) for more information.



# MCP795W1X/MCP795W2X

## REGISTER 5-12: EVENT DETECT 0x0B

R/W	R/W	R/W	R/W	R/W	R/W	R/W	R/W
EVHIF	EVLIF	EVEN1	EVEN0	EVWDT	EVLDB	EVHS1	EVHS0
bit 7	bit 6	bit 5	bit 4	bit 3	bit 2	bit 1	bit 0

### Legend:

R = Readable bit

W = Writable bit

U = Unimplemented bit, read as '0'

- bit 7      **EVHIF:** High-Speed Event Interrupt Flag bit  
When the configured number of high-speed events has occurred, the  $\overline{\text{IRQ}}$  pin is asserted and the EVHIF bit is set in hardware. To clear the interrupt and the  $\overline{\text{IRQ}}$  pin the EVHIF bit must be cleared in software.
- bit 6      **EVLIF:** Low-Speed Event Interrupt Flag bit  
When an event occurs on the low-speed pin, this  $\overline{\text{IRQ}}$  pin is asserted and the EVLIF bit is set. This bit must be cleared by software to reset the module and clear the  $\overline{\text{IRQ}}$  pin.
- bit 5:4    **EVEN<1:0>:** Event Detect Configuration bits  
These two bits determine what combination of the high and low-speed modules are enabled.
- 00 – Both modules are Off
  - 01 – Low-speed module enabled, high speed disabled
  - 10 – Low-speed module disabled, high speed enabled
  - 11 – Both modules are enabled
- bit 3      **EVWDT:** EVHS Watchdog Timer Reset Enable bit  
Setting this bit overrides any setting for the High-Speed Event Detection and allows the EVHS pin to clear the Watchdog Timer. This is edge triggered. Either an H-L or L-H transition will clear the WDT.
- bit 2      **EVLDB:** Low-Speed Event Detect Debounce Configuration bit  
This is the Low-Speed Event Debounce setting. Depending on the state of this bit, the low-speed pin will have to remain at the same state for the following periods to be considered valid.
- 0 – 31.25 ms
  - 1 – 500 ms
- bit 1-0    **EVHS<1:0>:** High-Speed Event Detect Configuration bits  
Determines how many high-speed events must occur before the EVHIF bit is set.  
All of these events must occur within 250 ms (based on the uncalibrated 32.768 kHz clock).
- 00 – 1<sup>st</sup> Event
  - 01 – 4<sup>th</sup> Event
  - 10 – 16<sup>th</sup> Event
  - 11 – 32<sup>nd</sup> Event

**Note 1:** Please see [Section 9.1.4, Event Detection](#) for more information.

# MCP795W1X/MCP795W2X

## 6.0 ALARM 0 REGISTERS

### REGISTER 6-1: SECONDS 0x0C

U-0		R/W		R/W	
—		10 Seconds		Seconds	
bit 7	bit 6	bit 4	bit 3	bit 0	

**Legend:**

R = Readable bit                      W = Writable bit                      U = Unimplemented bit, read as '0'

bit 7                      **Unimplemented:** Read as '0'  
bit 6-4                    **10 SECONDS<2:0>:** 10 Seconds  
bit 3-0                    **SECONDS<3:0>:** Seconds

**Note:** This contains the seconds match for the Alarm 0.

### REGISTER 6-2: MINUTES 0x0D

U-0		R/W		R/W	
—		10 Minutes		Minutes	
bit 7	bit 6	bit 4	bit 3	bit 0	

**Legend:**

R = Readable bit                      W = Writable bit                      U = Unimplemented bit, read as '0'

bit 7                      **Unimplemented:** Read as '0'  
bit 6-4                    **10 MINUTES<2:0>:** 10 Seconds  
bit 3-0                    **MINUTES<3:0>:** Seconds

**Note:** This contains the minutes match for the Alarm 0.

### REGISTER 6-3: HOURS 0x0E

U-0		R/W		R/W	
—		12/24	10 Hour AM/PM	10 Hour	Hour
bit 7	bit 6	bit 5	bit 4	bit 3	bit 0

**Legend:**

R = Readable bit                      W = Writable bit                      U = Unimplemented bit, read as '0'

bit 7                      **Unimplemented:** Read as '0'  
bit 6                      **12/24:** This is a copy of bit 6 in the Hours register (0x03)  
bit 5                      **10 HOUR AM/PM**  
bit 4                      **10 HOUR**  
bit 3-0                    **HOUR<3:0>**

**Note:** This contains the minutes match for the Alarm 0.

# MCP795W1X/MCP795W2X

## REGISTER 6-4: DAY 0x0F

R/W		R/W		R/W		R/W
ALM0PIN	ALM0C2	ALM0C1	ALM0C0	ALM0IF	Day	
bit 7	bit 6	bit 5	bit 4	bit 3	bit 2	bit 0

### Legend:

R = Readable bit                      W = Writable bit                      U = Unimplemented bit, read as '0'

bit 7                      **ALM0PIN:** Alarm 0 Output Pin Configuration bit  
 This pin configures the pin that is used for the Alarm 0 output. If this bit is clear the  $\overline{\text{IRQ}}$  pin is used. If set, the WDO pin is used. If the WDT is enabled then a valid alarm will assert the WDO pin for 122 us.

bit 6-4                      **ALM0C<2:0>:** Alarm 0 Configuration bits  
 Sets the condition on what the alarm will trigger. The following options are available:

- 000 – Seconds match
- 001 – Minutes match
- 010 – Hours match (logic takes into account 12/24 operation)
- 011 – Day match. Generates interrupt at 12:00:00 AM
- 100 – Date match
- 101 – Unimplemented, do not use
- 110 – Unimplemented, do not use
- 111 – Seconds, Minutes, Hour, Day, Date and Month

bit 3                      **ALM0IF:** Alarm 0 Interrupt Flag bit  
 This bit is set by hardware when an alarm condition has been generated. The bit must be cleared in software.

bit 2-0                      **DAY<2:0>**

**Note 1:** Contains the BCD day. The range is 1-7. Also, additional bits are used for configuration and status.

## REGISTER 6-5: DATE 0x10

U-0		U-0		R/W		R/W
—		—		10 Date		Date
bit 7	bit 6	bit 5	bit 4	bit 3	bit 0	

### Legend:

R = Readable bit                      W = Writable bit                      U = Unimplemented bit, read as '0'

bit 7-6                      **Unimplemented:** Read as '0'

bit 5-4                      **10 DATE<1:0>**

bit 3-0                      **DATE<3:0>**

# MCP795W1X/MCP795W2X

---

---

## REGISTER 6-6: MONTH 0x11

U-0	U-0	U-0	R/W	R/W
—	—	—	10 Month	Month
bit 7	bit 6	bit 5	bit 4	bit 3
				bit 0

### Legend:

R = Readable bit

W = Writable bit

U = Unimplemented bit, read as '0'

bit 7-5      **Unimplemented:** Read as '0'

bit 4      **10 MONTH**

bit 3-0      **MONTH<3:0>**

**Note 1:** Month match is only available on Alarm 0.

# MCP795W1X/MCP795W2X

## 7.0 ALARM 1 REGISTERS

### REGISTER 7-1: HUNDREDTHS OF SECONDS 0x12

R/W		R/W	
Tenth Seconds		Hundredths of Seconds	
bit 7	bit 4	bit 3	bit 0

**Legend:**

R = Readable bit                      W = Writable bit                      U = Unimplemented bit, read as '0'

bit 7-4                      **TENTH SECONDS<3:0>**: Tenth Seconds

bit 3-0                      **HUNDREDTHS OF SECONDS<3:0>**: Hundredths of Seconds

**Note 1:** Hundredths and Tenth seconds only available on Alarm 1.

### REGISTER 7-2: SECONDS 0x13

U-0	R/W		R/W	
—	10 Seconds		Seconds	
bit 7	bit 6	bit 4	bit 3	bit 0

**Legend:**

R = Readable bit                      W = Writable bit                      U = Unimplemented bit, read as '0'

bit 7                      **Unimplemented:** Read as '0'

bit 6-4                      **10 SECONDS<2:0>**: 10 Seconds

bit 3-0                      **SECONDS<3:0>**: Seconds

### REGISTER 7-3: MINUTES 0x14

U-0	R/W		R/W	
—	10 Minutes		Minutes	
bit 7	bit 6	bit 4	bit 3	bit 0

**Legend:**

R = Readable bit                      W = Writable bit                      U = Unimplemented bit, read as '0'

bit 7                      **Unimplemented:** Read as '0'

bit 6-4                      **10 MINUTES<2:0>**: 10 Minutes

bit 3-0                      **MINUTES<3:0>**: Minutes

# MCP795W1X/MCP795W2X

## REGISTER 7-4: HOURS 0x15

U-0		R/W		R/W	
—	12/24	10 Hour AM/PM	10 Hour	Hour	
bit 7	bit 6	bit 5	bit 4	bit 3	bit 0

### Legend:

R = Readable bit                      W = Writable bit                      U = Unimplemented bit, read as '0'

bit 7                      **Unimplemented:** Read as '0'  
bit 6                      **12/24**  
bit 5                      **10 HOUR AM/PM**  
bit 4                      **10 HOUR**  
bit 3-0                    **HOUR<3:0>**

## REGISTER 7-5: DAY 0x16

R/W		R/W		R/W		R/W	
ALM1PIN	ALM1C2	ALM1C1	ALM1C0	ALM1IF	Day		
bit 7	bit 6	bit 5	bit 4	bit 3	bit 2	bit 0	

### Legend:

R = Readable bit                      W = Writable bit                      U = Unimplemented bit, read as '0'

bit 7                      **ALM1PIN:** Alarm 1 Output Pin Configuration bit  
This pin configures the pin that is used for the Alarm 1 output. If this bit is clear the  $\overline{\text{IRQ}}$  pin is used. If set, the WDO pin is used. If the WDT is enabled then a valid Alarm will assert the  $\overline{\text{WDO}}$  pin for 122 us.

bit 6-4                    **ALM1C<2:0>:** Alarm 1 Configuration bits  
Sets the condition on what the Alarm will trigger. The following options are available:

- 000 – Seconds match
- 001 – Minutes match
- 010 – Hours match (logic takes into account 12/24 operation)
- 011 – Day match. Generates interrupt at 12:00:00 AM
- 100 – Date match
- 101 – Unimplemented, do not use
- 110 – Unimplemented, do not use
- 111 – Seconds, Minutes, Hour, Day, Date and Month

bit 3                      **ALM1IF:** Alarm 1 Interrupt Flag bit  
This bit is set by hardware when an alarm condition has been generated. The bit must be cleared in software.

bit 2-0                    **DAY<2:0>**

# MCP795W1X/MCP795W2X

## REGISTER 7-6: DATE 0x17

U-0	U-0	R/W	R/W		
—	—	10 Date	Date		
bit 7	bit 6	bit 5	bit 4	bit 3	bit 0

### Legend:

R = Readable bit

W = Writable bit

U = Unimplemented bit, read as '0'

bit 7-6      **Unimplemented:** Read as '0'

bit 5-4      **10 DATE<1:0>**

bit 3-0      **DATE<3:0>**

# MCP795W1X/MCP795W2X

## 8.0 POWER-DOWN TIME-STAMP REGISTERS

**Note:** It is strongly recommended that the timesaver function only be used when the oscillator is running. This will ensure accurate functionality.

### REGISTER 8-1: MINUTES 0x18

U-0		R/W		R/W	
—		10 Minutes		Minutes	
bit 7	bit 6	bit 4	bit 3	bit 0	

**Legend:**

R = Readable bit                      W = Writable bit                      U = Unimplemented bit, read as '0'

bit 7                      **Unimplemented:** Read as '0'  
 bit 6-4                  **10MINUTES<2:0>:** 10 Minutes  
 bit 3-0                  **MINUTES<3:0>:** Minutes

### REGISTER 8-2: HOURS 0x19

U-0		R/W		R/W	
—		12/24	10 Hour AM/PM	10 Hour	Hour
bit 7	bit 6	bit 5	bit 4	bit 3	bit 0

**Legend:**

R = Readable bit                      W = Writable bit                      U = Unimplemented bit, read as '0'

bit 7                      **Unimplemented:** Read as '0'  
 bit 6                      **12/24:** This is a copy of the status of the bit in register 0x03:6 at the time of the event  
 bit 5                      **10 HOUR AM/PM**  
 bit 4                      **10 HOUR**  
 bit 3-0                  **HOUR<3:0>**

### REGISTER 8-3: DATE 0x1A

U-0		U-0		R/W		R/W	
—		—		10 Date		Date	
bit 7	bit 6	bit 5	bit 4	bit 3	bit 0		

**Legend:**

R = Readable bit                      W = Writable bit                      U = Unimplemented bit, read as '0'

bit 7-6                  **Unimplemented:** Read as '0'  
 bit 5-4                  **10 DATE<1:0>**  
 bit 3-0                  **DATE<3:0>**



# MCP795W1X/MCP795W2X

## REGISTER 8-4: MONTH 0x1B

R/W			R/W		R/W	
Day			10 Month		Month	
bit 7	bit 6	bit 5	bit 4	bit 3	bit 0	

### Legend:

R = Readable bit

W = Writable bit

U = Unimplemented bit, read as '0'

bit 7-5      **DAY<2:0>**  
bit 4        **10 MONTH**  
bit 3-0     **MONTH<3:0>**

**Note 1:** Month match is only available on Alarm 0.

# MCP795W1X/MCP795W2X

## 9.0 POWER-UP TIME REGISTERS

**Note:** It is strongly recommended that the timesaver function only be used when the oscillator is running. This will ensure accurate functionality.

### REGISTER 9-1: MINUTES 0x1C

U-0		R/W		R/W	
—		10 Minutes		Minutes	
bit 7	bit 6	bit 4	bit 3	bit 0	

**Legend:**

R = Readable bit                      W = Writable bit                      U = Unimplemented bit, read as '0'

bit 7                      **Unimplemented:** Read as '0'  
 bit 6-4                 **10 MINUTES<2:0>:** 10 Minutes  
 bit 3-0                 **MINUTES<3:0>:** Minutes

### REGISTER 9-2: HOURS 0x1D

U-0		R/W		R/W	
—		12/24	10 Hour AM/PM	10 Hour	Hour
bit 7	bit 6	bit 5	bit 4	bit 3	bit 0

**Legend:**

R = Readable bit                      W = Writable bit                      U = Unimplemented bit, read as '0'

bit 7                      **Unimplemented:** Read as '0'  
 bit 6                      **12/24:** This is a copy of the status of the bit in register 0x03:6 at the time of the event  
 bit 5                      **10 HOUR AM/PM**  
 bit 4                      **10 HOUR**  
 bit 3-0                 **HOUR<3:0>**

### REGISTER 9-3: DATE 0x1E

U-0		U-0		R/W		R/W	
—		—		10 Date		Date	
bit 7	bit 6	bit 5	bit 4	bit 3	bit 0		

**Legend:**

R = Readable bit                      W = Writable bit                      U = Unimplemented bit, read as '0'

bit 7-6                 **Unimplemented:** Read as '0'  
 bit 5-4                 **10 DATE<1:0>**  
 bit 3-0                 **DATE<3:0>**

# MCP795W1X/MCP795W2X

## REGISTER 9-4: MONTH 0x1F

R/W			R/W		R/W	
Day			10 Month		Month	
bit 7	bit 6	bit 5	bit 4	bit 3	bit 0	

### Legend:

R = Readable bit

W = Writable bit

U = Unimplemented bit, read as '0'

bit 7-5      **DAY<2:0>**  
bit 4        **10 MONTH**  
bit 3-0      **MONTH<3:0>**

# MCP795W1X/MCP795W2X

## 9.1 Features

### 9.1.1 CALIBRATION

The Calibration register (0x09h) allows a number of RTCC counts to be added or subtracted (CALSGN bit located at 0x03:7) each minute. This allows for calibration to reduce the PPM error due to oscillator shift. This register is volatile.

The CALSGN bit determines if calibration is positive or negative.

A value of 0x00 in the Calibration register will result in no calibration.

The calibration is linear, with one bit representing two RTC clocks.

The MCP795WXX utilizes digital calibration to correct for the inaccuracies of the input clock source (either external or crystal). Calibration is enabled by setting the value of the Calibration register at address 08H. Calibration is achieved by adding or subtracting a number of input clock cycles per minute in order to achieve ppm level adjustments in the internal timing function of the MCP795WXX.

The CALSGN bit is the calibration sign bit, with a '1' indicating subtraction and a '0' indicating addition. The eight bits in the Calibration register indicate the number of input clock cycles (multiplied by two) that are subtracted or added per minute to the internal timing function.

The internal timing function can be monitored using the CLKOUT output pin by setting bit 6 (SQWE) and bits <2:0> (RS2, RS1, RS0) of the Control register at address 07H. Note that the CLKOUT output waveform is disabled when the MCP795WXX is running in VBAT mode. With the SQWE bit set to '1', there are two methods that can be used to observe the internal timing function of the MCP795WXX:

Method 1. RS2 bit set to '0'

With the RS2 bit set to '0', the RS1 and RS0 bits enable the following internal timing signals to be output on the CLKOUT pin:

RS2	RS1	RS0	Output Signal
0	0	0	1 Hz
0	0	1	4.096 kHz
0	1	0	8.192 kHz
0	1	1	32.768 kHz

The frequencies listed in the table presume an input clock source of exactly 32.768 kHz. In terms of the equivalent number of input clock cycles, the table becomes:

RS2	RS1	RS0	Output Signal
0	0	0	32768
0	0	1	8
0	1	0	4
0	1	1	1

With regards to the calibration function, the Calibration register setting has no impact upon the CLKOUT output clock signal when bits RS1 and RS0 are set to '11'. The setting of the Calibration register to a non-zero value enables the calibration function which can be observed on the CLKOUT output pin. The calibration function can be expressed in terms of the number of input clock cycles added/subtracted from the internal timing function.

With bits RS1 and RS0 set to '00', the calibration function can be expressed as:

$$T_{\text{output}} = (32768 \pm (2 * \text{CALREG})) T_{\text{input}}$$

where:

$$T_{\text{output}} = \text{clock period of CLKOUT output signal}$$

$$T_{\text{input}} = \text{clock period of input signal}$$

$$\text{CALREG} = \text{decimal value of Calibration register setting and the sign is determined by the CALSGN bit.}$$

Since the calibration is done once per minute (i.e., when the internal minute counter is incremented), only one cycle in sixty of the CLKOUT output waveform is affected by the calibration setting. Also note that the duty cycle of the CLKOUT output waveform will not necessarily be at 50% when the calibration setting is applied.

With bits RS1 and RS0 set to '01' or '10', the calibration function can not be expressed in terms of the input clock period. In the case where the MSB of the Calibration register is set to '0', the waveform appearing at the CLKOUT output pin will be "delayed", once per minute, by twice the number of input clock cycles defined in the Calibration register. The CLKOUT waveform will appear as shown in [Figure 9-1](#).

# MCP795W1X/MCP795W2X

In the case where the MSB of the Calibration register is set to '1', the CLKOUT output waveforms that appear when bits RS1 and RS0 are set to '01' or '10' are not as responsive to the setting of the Calibration register. For example, when outputting the 4.096 kHz waveform (RS1, RS0 set to '01'), the output waveform is generated using only eight input clock cycles. Consequently, attempting to subtract more than eight input clock cycles from this output does not have a meaningful affect on the resulting waveform. Any affect on the output will appear as a modification in both the frequency and duty cycle of the waveform appearing on the CLKOUT output pin.

Method 2. RS2 bit set to '1'

With the RS2 bit set to '1', the following internal timing signal is output on the CLKOUT pin:

RS2	RS1	RS0	Output Signal
1	x	x	1.0 Hz

The frequency listed in the table presumes an input clock source of exactly 32.768 kHz. In terms of the equivalent number of input clock cycles, the table becomes:

RS2	RS1	RS0	Output Signal
1	x	x	32768

Unlike the method previously described, the calibration setting is continuously applied and affects every cycle of the output waveform. This results in the modulation of the frequency of the output waveform based upon the setting of the Calibration register.

Using this setting, the calibration function can be expressed as:

$$T_{\text{output}} = (32768 \pm (2 * \text{CALREG})) T_{\text{input}}$$

where:

$$T_{\text{output}} = \text{clock period of CLKOUT output signal}$$

$$T_{\text{input}} = \text{clock period of input signal}$$

$$\text{CALREG} = \text{decimal value of Calibration register setting and the sign is determined by the CALSGN bit.}$$

Since the calibration is done every cycle, the frequency of the output CLKOUT waveform is constant.

**FIGURE 9-1: CLKOUT WAVEFORM**

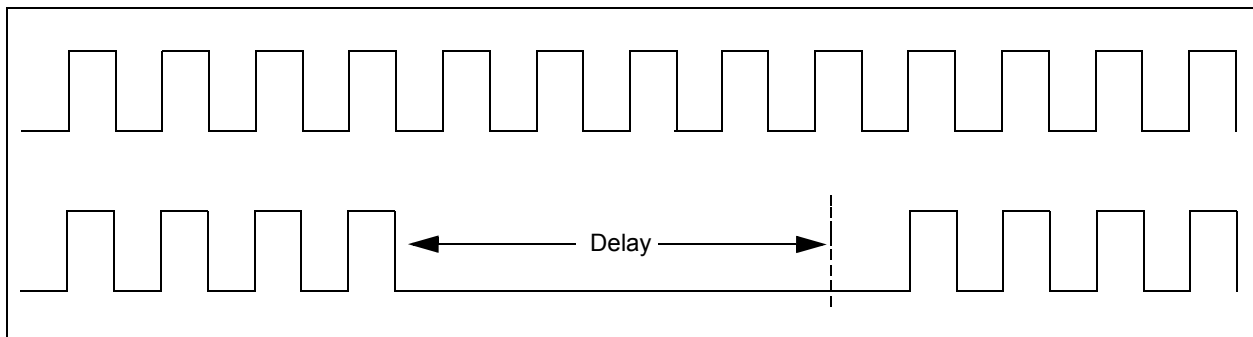

# MCP795W1X/MCP795W2X

## 9.1.2 CLOCKOUT FUNCTION

The MCP795W20 features a push-pull pin CLKOUT that can supply a digital signal based on a division of the main 32.768 kHz clock. If this function is not used the pin may be directly controlled using the OUT bit in the Control register (0x08). In VBAT mode, CLKOUT is logic low. In VDD POR condition, the CLKOUT is tri-stated.

## 9.1.3 WATCHDOG TIMER

The on-board Watchdog Timer is configured by loading the register at address 0x0A. The WDT is not available when the MCP795WXX is operating from the VBAT supply. When in this condition, the WDT is disabled by the hardware and must be re-enabled when VCC is restored. The output of the WDT is based on the un-calibrated 32.768 kHz oscillator.

Description of WDT Bits:

- Bit 7 is a read/write bit that is set and cleared by software. This bit is set to enable the WDT function and cleared to disable the function. A VCC power fail will cause this bit to be cleared and not re-enabled when VCC is restored.
- Bit 6 is a read/write bit that is set in hardware when the WDT times out and the  $\overline{WDO}$  pin is asserted. This bit must be cleared in software to restart the WDT.
- Bit 5 is a read/write bit and is set to enable a 64-second delay before the WDT starts to count. If this bit is set and the WDTIF bit is cleared then there will be a 64-second delay before the WDT starts to count. This bit should be set before the WDTEN bit is set.
- Bit 4 is a read/write bit that is used to select the pulse width on the  $\overline{WDO}$  pin when the WDT times out.
  - 0 – 122 us Pulse
  - 1 – 125 ms Pulse
- Bits <3:0> are read/write bits that are used to set the WDT time-out period as below (all times are based off the uncalibrated crystal reference). Bit 3 should be cleared and is reserved for future use:
  - 000 – 977 us
  - 001 – 15.6 ms
  - 010 – 62.5 ms
  - 011 – 125 ms
  - 100 – 1s
  - 101 – 16s
  - 110 – 32s
  - 111 – 64s

To reset the WDT the CLRWDT instruction must be issued over the SPI interface, as shown in Figure 9-7. If the WDT is not cleared with the CLRWDT command before time-out then the  $\overline{WDO}$  pin will assert and the WDTIF bit will be set. The WDTIF bit must be cleared by software to restart the WDT.

## 9.1.4 EVENT DETECTION

The on-chip event detection consists of two separate detection circuits.

The high-speed circuit is designed to operate with a digital signal from the output of an external signal conditioning circuit. The input is edge triggered, and will generate an interrupt when the correct number of events has occurred.

The low-speed circuit is designed to operate directly with mechanical switches and support built-in switch debounce.

Registers associated with the event detection module:

- EVHIF – When the configured number of high speed events has occurred the  $\overline{IRQ}$  pin is asserted and the EVHIF bit is set. This bit must be cleared by software to reset the module and clear the  $\overline{IRQ}$  pin.
- EVLIF – When an event occurs on the low-speed pin this  $\overline{IRQ}$  pin is asserted and the EVLIF bit is set. This bit must be cleared by software to reset the module and clear the  $\overline{IRQ}$  pin.
- EVEN<1:0> – These two bits determine what combination of the high and low-speed modules are enabled.
  - 00 – Both modules are off
  - 01 – Only low-speed module enabled
  - 10 – Only high-speed module disabled
  - 11 – Both modules are enabled
- EVWDT – setting this bit overrides any setting for the High-Speed Event Detection and allows the EVHS pin to clear the Watchdog Timer. This is edge triggered. Either H-L or L-H transition will clear the WDT.
- EVLDB – This is the low-speed event debounce setting. Depending on the state of this bit the low-speed pin will have to remain at the same state for the following periods to be considered valid.
  - 0 – 31.25 ms
  - 1 – 500 ms

# MCP795W1X/MCP795W2X

The debounce will only operate if the clock is running and these timings are based on the uncalibrated 32.768 kHz clock.

- EVHS<1:0> – These bits determine how many high-speed events must occur before the EVHIF bit is set. All of these events must occur within 250 ms.
  - 00 – 1st Event
  - 01 – 4th Event
  - 10 – 16th Event
  - 11 – 32nd Event

## 9.1.5 VBAT SWITCHOVER

If the VBAT feature is not used, the VBAT pin should be connected to GND. A low value series resistor and Schottky diode are recommended between the external battery and the VBAT pin to reduce inrush current and also to prevent any leakage current reaching the external VBAT source.

The VTRIP point is defined as 1.5V typical. When VDD falls below 1.5V the system will continue to operate the RTCC and SRAM using the VBAT supply. There is ~50mV hyst in the trip point changeover. The following conditions apply:

**TABLE 9-1: VBAT CHANGOVER CONDITIONS**

Supply Condition	Read/Write Access	Powered By
$VCC < V_{TRIP}, VCC < V_{BAT}$	No	VBAT
$VCC > V_{TRIP}, VCC < V_{BAT}$	Yes	VCC
$VCC > V_{TRIP}, VCC > V_{BAT}$	Yes	VCC

For more information on VBAT conditions see the RTCC Best Practices Application Note, AN1365 (DS01365).

## 9.1.6 UNIQUE ID LOCATIONS

When the unique ID locations are preprogrammed from the factory with either an EUI-48 or EUI-64, the EUI code is programmed into location 0x00-0x07. Locations 0x08-0x0F are blank (0xFF).

**Note:** For EUI-64, the data is located in address 0x00-0x07. For EUI-48 locations, 0x02-0x07 contain the data. 0x00/01 contain 0xFF.

To read the unique ID location the IDREAD command is given with the starting address. Valid addresses are 0x00 through 0x0F. All 16 bytes can be read out in a single command by clocking the device. Trying to access locations past 0x0F will result in the address wrapping within these 16 bytes.

**FIGURE 9-2: IDREAD COMMAND SEQUENCE**

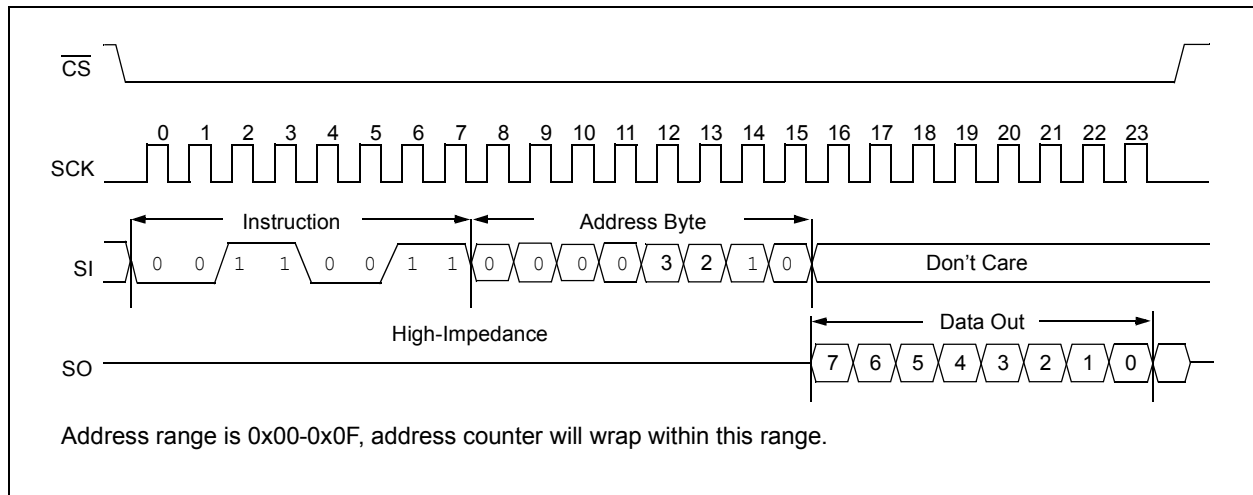

To write to the unique ID locations, the IDWRITE command is used. The device must be write enabled and the correct unlock sequence must have been performed. See [Section 10.1.4, Write to the Unlock Register](#) for more details.

The ID locations can be written to using the IDWRITE command. The valid address is between 0x00 and 0x0F. The entire 16 bytes must be written in two groups of eight bytes. A maximum of eight bytes can be written at once.

# MCP795W1X/MCP795W2X

**FIGURE 9-3: IDWRITE COMMAND SEQUENCE**

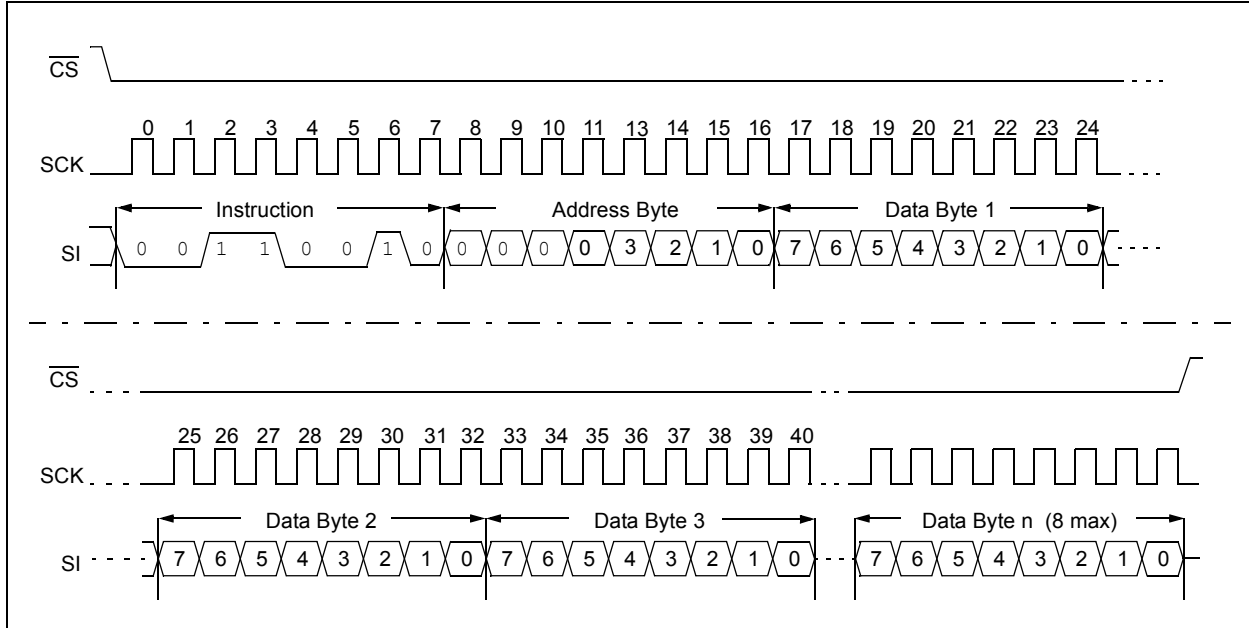



## 9.1.7 POWER-FAIL TIME-STAMP

The MCP795WXX family of RTCC devices feature a power-fail time-stamp feature. This feature will save the time at which VCC crosses the VTRIP voltage and is shown in Figure 9-4. To use this feature, a VBAT supply must be present and the oscillator must also be running. There are two separate sets of registers that are used to record this information:

- The first set located at 0x18h through 0x1Bh are loaded at the time when VCC falls below VTRIP and the RTCC operates on the VBAT. The VBAT (register 0x03h bit 4) bit is also set at this time.

- The second set of registers, located at 0x1Ch through 0x1Fh, are loaded at the time when VCC is restored and the RTCC switches to VCC.

The power-fail time-stamp registers are cleared when the VBAT bit is cleared in software.

**Note:** It is strongly recommended that the time-saver function only be used when the oscillator is running. This will ensure accurate functionality.

**FIGURE 9-4: POWER-FAIL GRAPH**

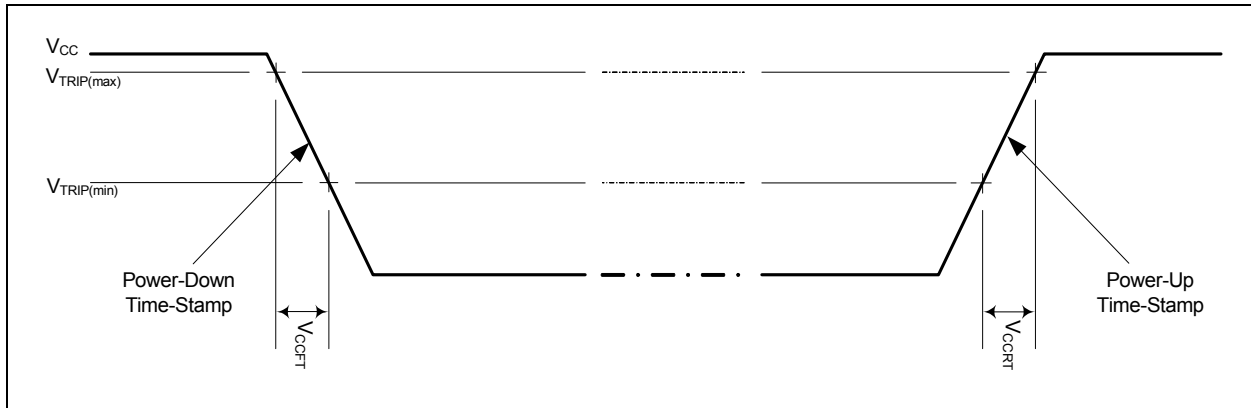

## 9.1.8 READ STATUS REGISTER (SRREAD)

See Figure 9-5 for the RDSR timing sequence.

The Read Status Register (SRREAD) instruction provides access to the STATUS register. The STATUS register may be read at any time, even during a write cycle. The STATUS register is formatted as follows:

7	6	5	4	3	2	1	0
—	—	—	—	R/W	R/W	R	R
X	X	X	X	BP1	BP0	WEL	WIP

The **Write-In-Process (WIP)** bit indicates whether the MCP795WXX is busy with a nonvolatile memory write operation. When set to a '1', a write is in progress, when set to a '0', no write is in progress. This bit is read-only.

The **Write Enable Latch (WEL)** bit indicates the status of the write enable latch. When set to a '1', the latch allows writes to the nonvolatile memory, when set to a '0', the latch prohibits writes to the nonvolatile memory. The state of this bit can always be updated via the WREN or WRDI commands, regardless of the state of write protection on the STATUS register. This bit is read-only.

The **Block Protection (BP0 and BP1)** bits indicate which blocks are currently write-protected. These bits are set by the user issuing the WRSR instruction. These bits are nonvolatile.

# MCP795W1X/MCP795W2X

FIGURE 9-5: READ STATUS REGISTER TIMING SEQUENCE

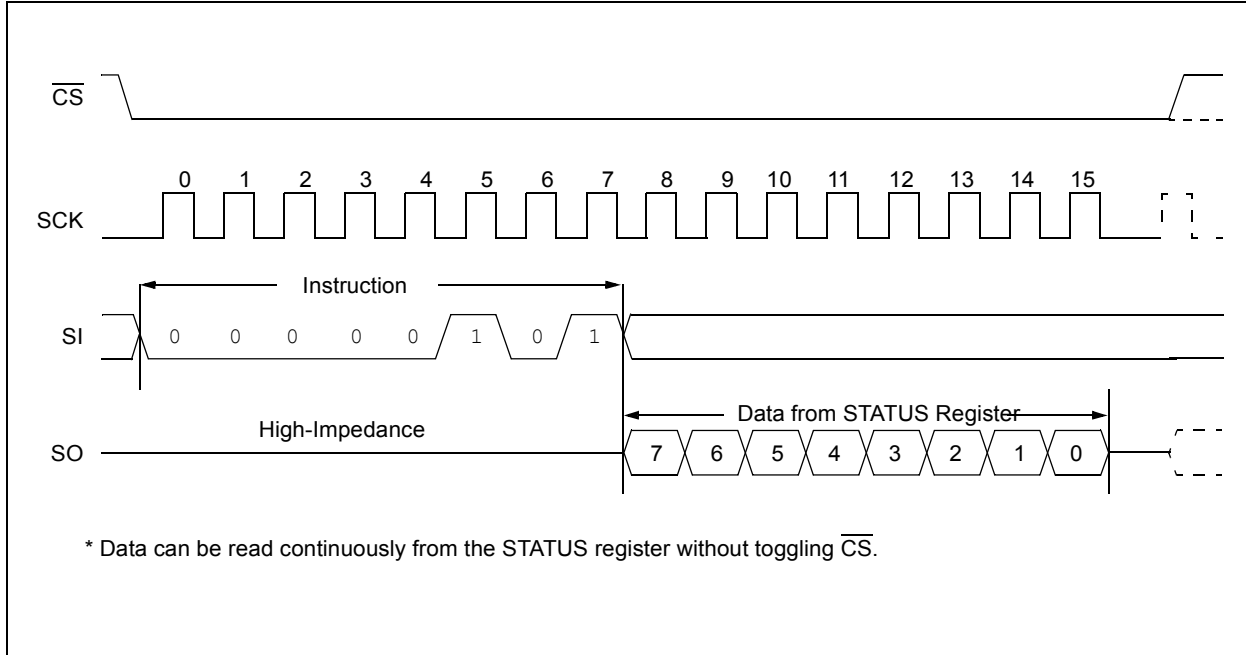

## 9.1.9 WRITE STATUS REGISTER (SRWRITE)

The Write Status Register (*SRWRITE*) instruction allows the user to select one of four levels of protection for the array by writing to the appropriate bits in the STATUS register. The array is divided up into four segments. The user has the ability to write-protect none, one, two, or all four of the segments of the array. The partitioning is controlled as shown in [Table 9-2](#).

See [Figure 9-6](#) for the *SRWRITE* timing sequence.

**TABLE 9-2: ARRAY PROTECTION**

BP1	BP0	Array Addresses Write-Protected (2 kbit shown)
0	0	none
0	1	upper 1/4 (C0h-FFh)
1	0	upper 1/2 (80h-FFh)
1	1	all (00h-FFh)

**FIGURE 9-6: WRITE STATUS REGISTER TIMING SEQUENCE**

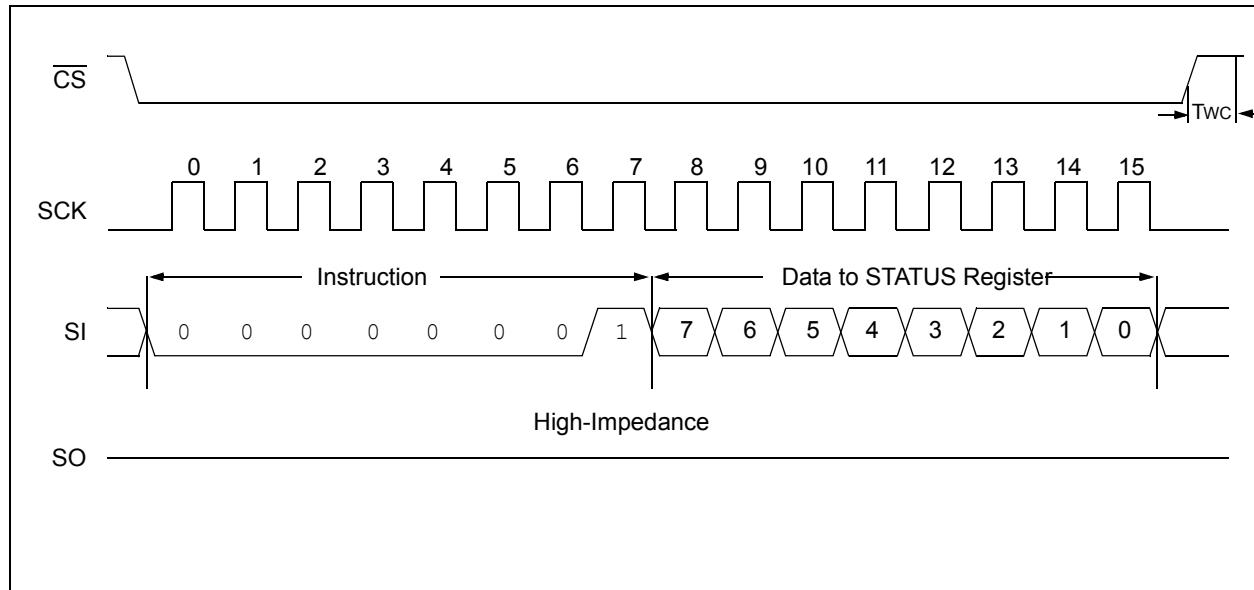

# MCP795W1X/MCP795W2X

## 9.1.10 DATA PROTECTION

The following protection has been implemented to prevent inadvertent writes to the array:

- The write enable latch is reset on power-up
- A Write Enable instruction must be issued to set the write enable latch
- After a byte write, page write, unique ID write, or STATUS register write, the write enable latch is reset

- $\overline{\text{CS}}$  must be set high after the proper number of clock cycles to start an internal write cycle
- Access to the array during an internal EEPROM write cycle is ignored and programming is continued
- Block protect bits are ignored for UID writes

## 9.1.11 CLEAR WATCHDOG INSTRUCTION

The Clear Watchdog command resets the internal Watchdog Timer.

**FIGURE 9-7: CLRWDT**

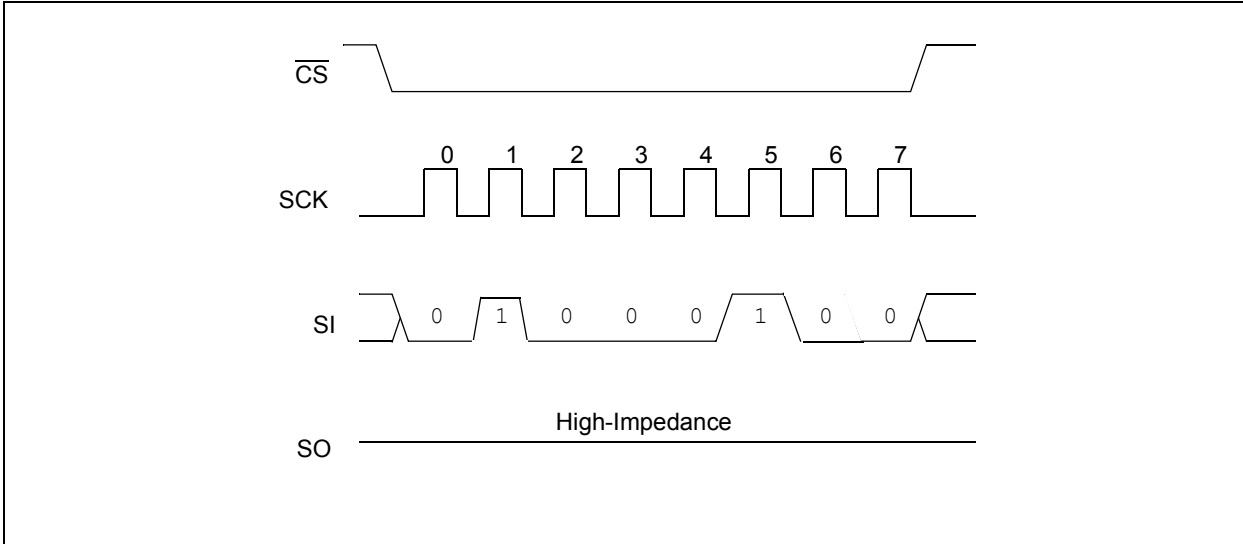

## 9.1.12 CLEAR RAM INSTRUCTION

The Clear Ram instruction is a 2-byte command that will reset the internal SRAM to the known value. Using this command, all locations in the SRAM are set to 00h and the data value contained in the second byte of the command is ignored.

**FIGURE 9-8: CLRDRAM**

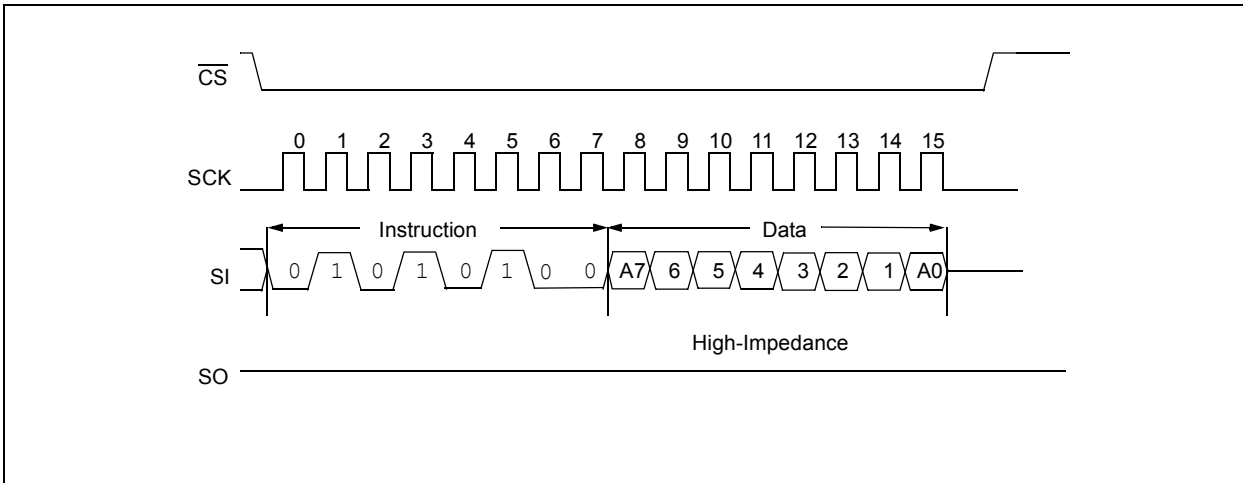

## 9.2 Crystal Specification and Selection

The MCP795WXX has been designed to operate with a standard 32.768 kHz tuning fork crystal. The on-board oscillator has been characterized to operate with a crystal of maximum ESR of 70K Ohms.

Crystals with a comparable specification are also suitable for use with the MCP795WXX.

The table below is given as design guidance and a starting point for crystal and capacitor selection.

Manufacturer	Part Number	Crystal Capacitance	CX1 Value	CX2 Value
Micro Crystal	CM7V-T1A	7pF	10pF	12pF
Citizen	CM200S-32.768KDZB-UT	6pF	10pF	8 pF
Please work with your crystal vendor.				

### EQUATION 9-1:

$$C_{load} = \frac{CX2 \times CX1}{CX2 + CX1} + C_{stray}$$

The following must also be taken into consideration:

- Pin capacitance (to be included in Cx2 and Cx1)
- Stray Board Capacitance

The recommended board layout for the oscillator area is shown in [Figure 9-9](#). This actual board shows the crystal and the load capacitors. In this example, C2 is CX1, C1 is CX2 and the crystal is designated as Y1.

When calculating the effective load capacitance, [Equation 9-1](#) can be used.

Gerber files are available on request. Please contact your Microchip Sales representative.

It is required that the final application should be tested with the chosen crystal and capacitor combinations across all operating and environmental conditions. Please also consult with the crystal specification to observe correct handling and reflow conditions and for information on ideal capacitor values.

For more information please see the RTCC Best Practices AN1365 (DS01365).

**FIGURE 9-9: BOARD LAYOUT**

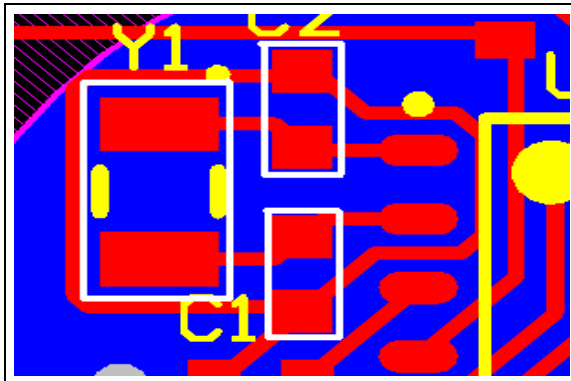

# MCP795W1X/MCP795W2X

## 10.0 ON-BOARD MEMORY

The MCP795WXX has both on-board EEPROM memory and battery-backed SRAM. The SRAM is arranged as 64 x 8 bytes and is retained when Vcc supply is removed. The EEPROM is organized as 256/128 x 8 bytes. The EEPROM is nonvolatile and does not require VBAT supply for retention.

### 10.1 SRAM

The SRAM array is a battery-backed-up array of 64 bytes. The SRAM is accessed using the Read and Write commands, starting at address 0x20h.

Upon power-up the SRAM locations are in an undefined state but can be set to a known value using the CLRRAM instruction (Figure 9-8).

#### 10.1.1 SRAM/RTCC OPERATION

The MCP795WXX contains a Real-Time Clock and Calendar. The RTCC registers and SRAM array are accessed using the same commands. The RTCC registers and SRAM array are powered internally from the switched supply that is either connected to Vcc or VBAT supply. No external read/write operations are permitted when the device is running from the VBAT supply.

Table 3-1 contains a list of the possible instruction bytes and format for device operation.

#### 10.1.2 READ SEQUENCE

The part is selected by pulling  $\overline{CS}$  low. The 8-bit READ instruction is transmitted to the MCP795W20 followed by the 8-bit address (A7 through A0). After the correct READ instruction and address are sent, the data stored in the memory at the selected address is shifted out on the SO pin. The data stored in the memory at the next address can be read sequentially by continuing to provide clock pulses. The internal Address Pointer is automatically incremented to the next higher address after each byte of data is shifted out.

As the RTCC registers are separate from the SRAM array, when reading the RTCC registers set the address will wrap back to the start of the RTCC registers. Also when an address within the SRAM array is loaded the internal Address Pointer will wrap back to the start of the SRAM array. The READ instruction can be used to read the registers and array indefinitely by continuing to clock the device. The read operation is terminated by raising the  $\overline{CS}$  pin (Figure 10-1).

#### 10.1.3 WRITE SEQUENCE

As the RTCC registers and SRAM array do not require the WREN sequence like the nonvolatile memory, the user may proceed by setting the  $\overline{CS}$  low, issuing the WRITE instruction, followed by the address, and then the data to be written. As no write cycle is required for the RTCC registers and SRAM array the entire contents can be written in a single command.

For the last data byte to be written to the RTCC registers and SRAM array, the  $\overline{CS}$  must be brought high after the last byte has been clocked in. If  $\overline{CS}$  is brought high at any other time, the last byte will not be written. Refer to Figure 10-2 for more detailed illustrations on the write sequence.

FIGURE 10-1: READ SEQUENCE

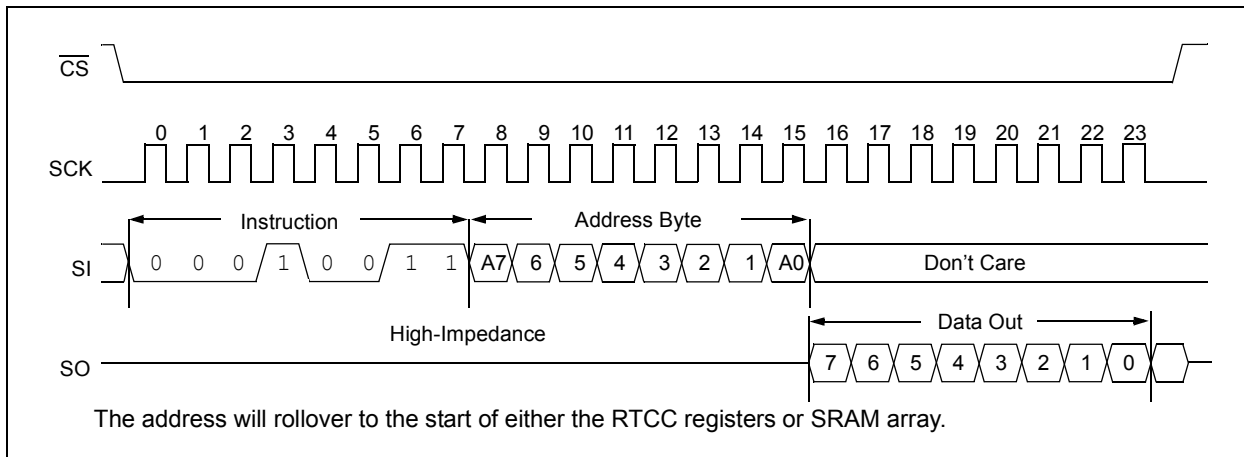

**FIGURE 10-2: WRITE SEQUENCE**

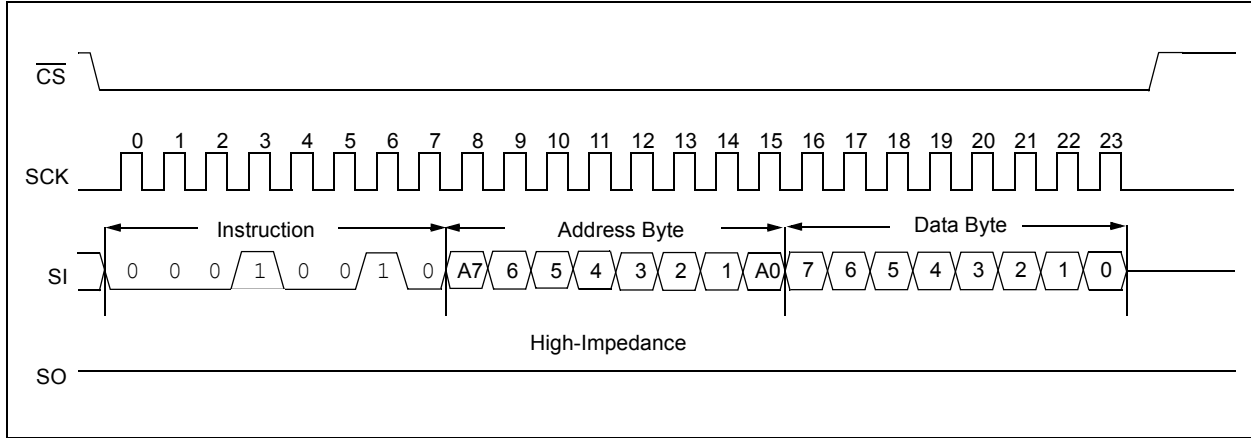

## 10.1.4 WRITE TO THE UNLOCK REGISTER

The MCP795WXX contains a protected area of 64 bits that can be used to hold a unique ID, such as a serial number or MAC address code. To gain write access to these locations, a specific sequence is required. Any deviation from this sequence will reset the lock on these locations. Once these locations have been unlocked they have to be written to in the next command by issuing the correct command. A write to a different location will lock the ID locations and clear the WEL bit.

The following is a list of strict conditions which have to be followed before the unique locations can be written to:

- EEWREN instruction successfully executed
- UNLOCK 0x55 instruction successfully executed
- UNLOCK 0xAA instruction successfully executed

To issue each UNLOCK instruction the Unlock command is sent followed by 0x55. Then in a separate command the Unlock command is issued followed by 0xAA. It is a requirement that each command be separate, that is  $\overline{CS}$  must toggle between each command.

Information on how to read and write the ID locations is detailed in [Section 9.1.6, Unique ID Locations](#).

**FIGURE 10-3: UNLOCK SEQUENCE**

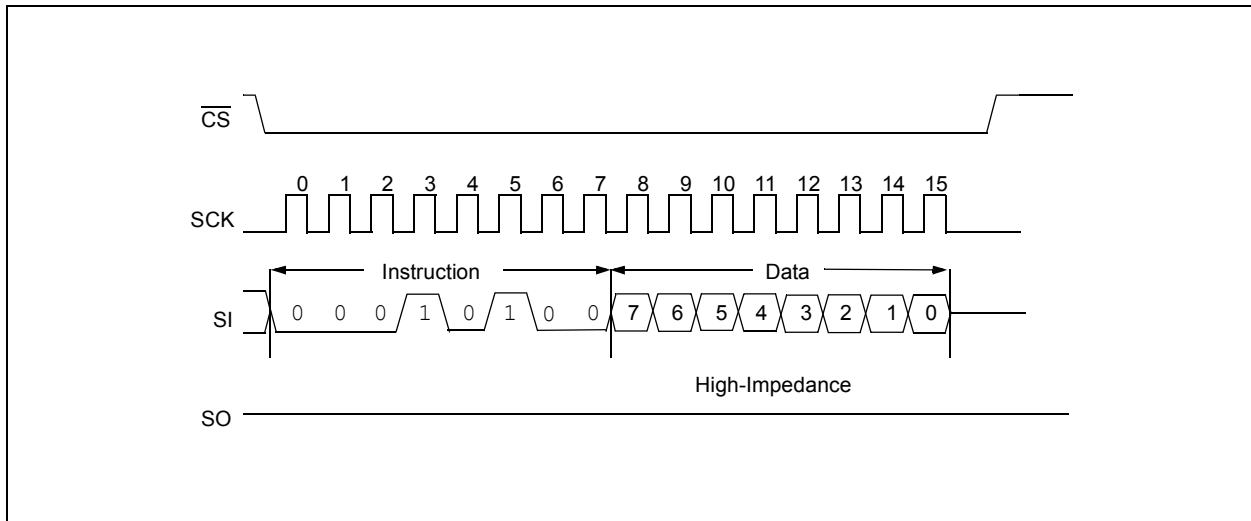

# MCP795W1X/MCP795W2X

## 11.0 PACKAGING INFORMATION

### 11.1 Package Marking Information

14-Lead SOIC (.150")



Example

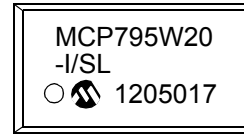

14-Lead TSSOP

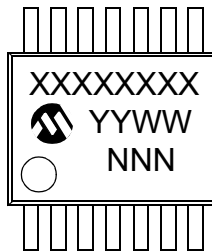

Example

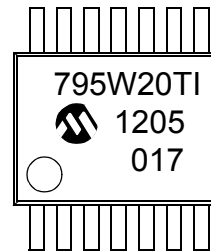

Part Number	1st Line Marking Codes	
	SOIC	TSSOP
MCP795W20	MCP795W20	795W20T
MCP795W10	MCP795W10	795W10T
MCP795W21	MCP795W21	795W21T
MCP795W11	MCP795W11	795W11T
MCP795W22	MCP795W22	795W22T
MCP795W12	MCP795W12	795W12T

**Note:** T = Temperature grade  
NNN = Alphanumeric traceability code

**Legend:** XX...X Customer-specific information  
Y Year code (last digit of calendar year)  
YY Year code (last 2 digits of calendar year)  
WW Week code (week of January 1 is week '01')  
NNN Alphanumeric traceability code  
ⓔ3 Pb-free JEDEC designator for Matte Tin (Sn)  
\* This package is Pb-free. The Pb-free JEDEC designator (ⓔ3) can be found on the outer packaging for this package.

**Note:** In the event the full Microchip part number cannot be marked on one line, it will be carried over to the next line, thus limiting the number of available characters for customer-specific information.



# MCP795W1X/MCP795W2X

## 14-Lead Plastic Small Outline (SL) - Narrow, 3.90 mm Body [SOIC]

**Note:** For the most current package drawings, please see the Microchip Packaging Specification located at <http://www.microchip.com/packaging>

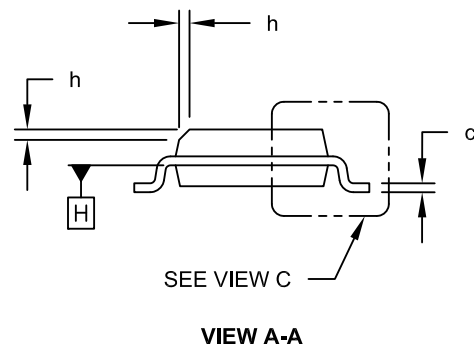
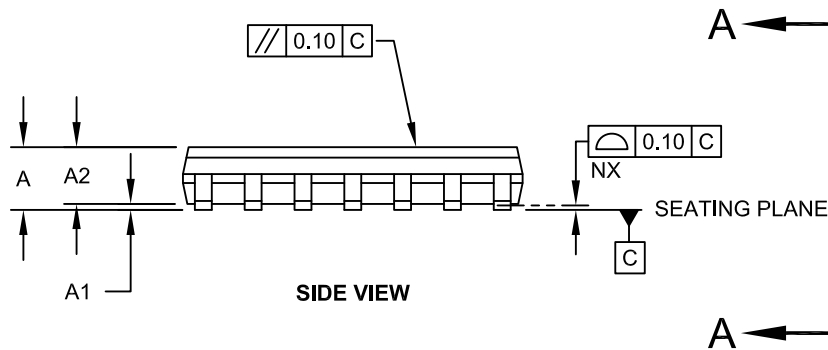
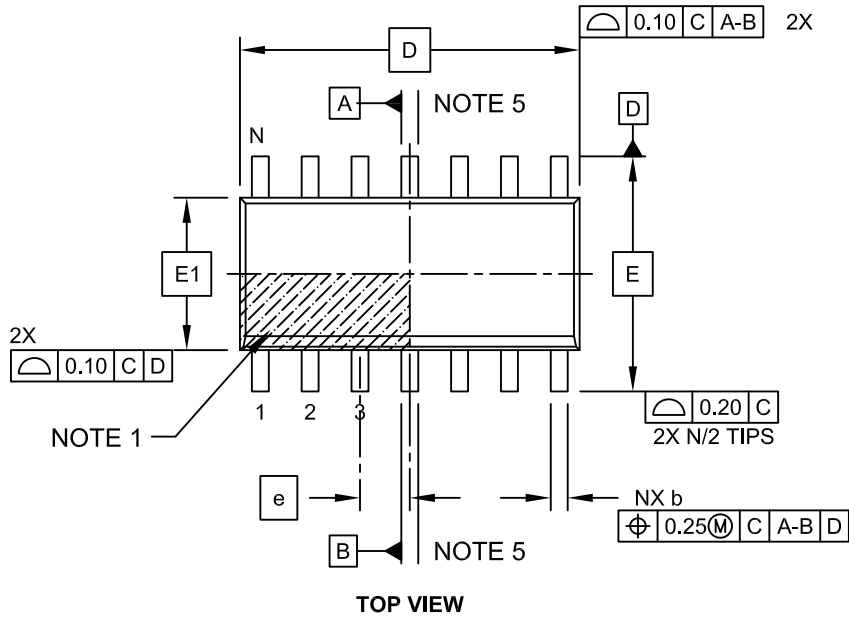

Microchip Technology Drawing No. C04-065C Sheet 1 of 2

# MCP795W1X/MCP795W2X

## 14-Lead Plastic Small Outline (SL) - Narrow, 3.90 mm Body [SOIC]

**Note:** For the most current package drawings, please see the Microchip Packaging Specification located at <http://www.microchip.com/packaging>

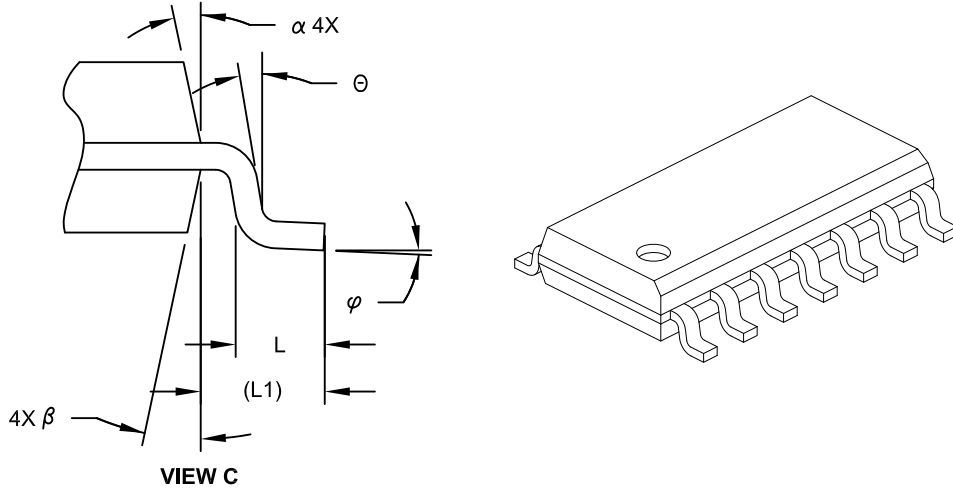

Dimension Limits	Units	MILLIMETERS		
		MIN	NOM	MAX
Number of Pins	N	14		
Pitch	e	1.27 BSC		
Overall Height	A	-	-	1.75
Molded Package Thickness	A2	1.25	-	-
Standoff §	A1	0.10	-	0.25
Overall Width	E	6.00 BSC		
Molded Package Width	E1	3.90 BSC		
Overall Length	D	8.65 BSC		
Chamfer (Optional)	h	0.25	-	0.50
Foot Length	L	0.40	-	1.27
Footprint	L1	1.04 REF		
Lead Angle	$\theta$	0°	-	-
Foot Angle	$\phi$	0°	-	8°
Lead Thickness	c	0.10	-	0.25
Lead Width	b	0.31	-	0.51
Mold Draft Angle Top	$\alpha$	5°	-	15°
Mold Draft Angle Bottom	$\beta$	5°	-	15°

**Notes:**

- Pin 1 visual index feature may vary, but must be located within the hatched area.
- § Significant Characteristic
- Dimension D does not include mold flash, protrusions or gate burrs, which shall not exceed 0.15 mm per end. Dimension E1 does not include interlead flash or protrusion, which shall not exceed 0.25 mm per side.
- Dimensioning and tolerancing per ASME Y14.5M  
BSC: Basic Dimension. Theoretically exact value shown without tolerances.  
REF: Reference Dimension, usually without tolerance, for information purposes only.
- Datums A & B to be determined at Datum H.

Microchip Technology Drawing No. C04-065C Sheet 2 of 2

# MCP795W1X/MCP795W2X

14-Lead Plastic Small Outline (SL) - Narrow, 3.90 mm Body [SOIC]

**Note:** For the most current package drawings, please see the Microchip Packaging Specification located at <http://www.microchip.com/packaging>

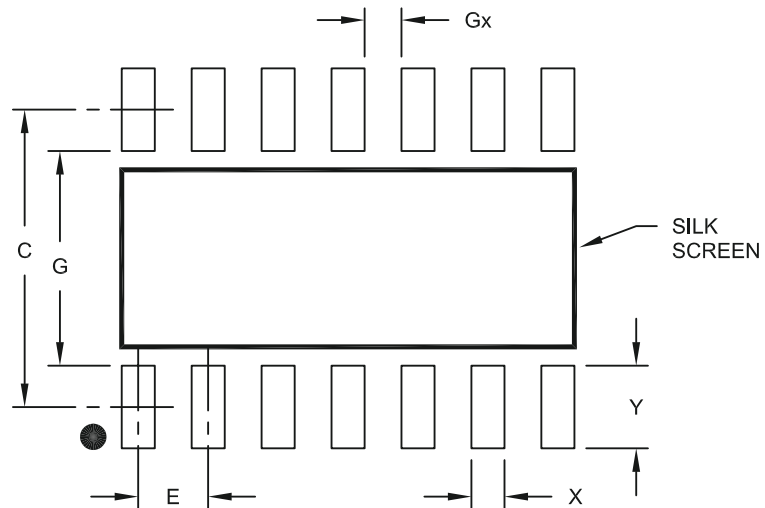

RECOMMENDED LAND PATTERN

Dimension Limits	Units	MILLIMETERS		
		MIN	NOM	MAX
Contact Pitch	E	1.27 BSC		
Contact Pad Spacing	C		5.40	
Contact Pad Width	X			0.60
Contact Pad Length	Y			1.50
Distance Between Pads	Gx	0.67		
Distance Between Pads	G	3.90		

Notes:

1. Dimensioning and tolerancing per ASME Y14.5M

BSC: Basic Dimension. Theoretically exact value shown without tolerances.

Microchip Technology Drawing No. C04-2065A

# MCP795W1X/MCP795W2X

## 14-Lead Plastic Thin Shrink Small Outline (ST) - 4.4 mm Body [TSSOP]

**Note:** For the most current package drawings, please see the Microchip Packaging Specification located at <http://www.microchip.com/packaging>

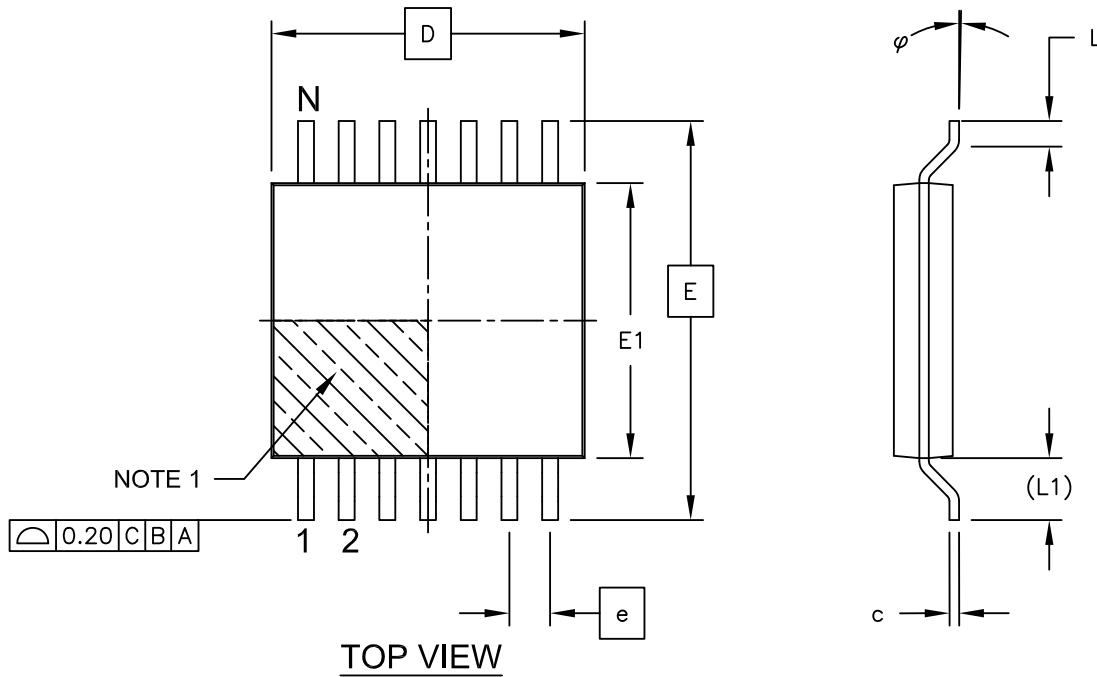

Microchip Technology Drawing C04-087C Sheet 1 of 2

# MCP795W1X/MCP795W2X

## 14-Lead Plastic Thin Shrink Small Outline (ST) - 4.4 mm Body [TSSOP]

**Note:** For the most current package drawings, please see the Microchip Packaging Specification located at <http://www.microchip.com/packaging>

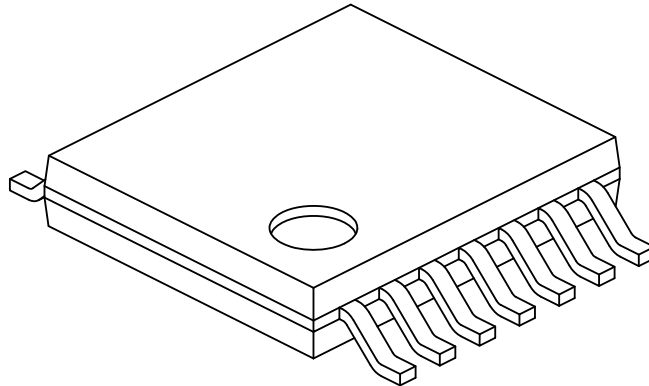

Dimension Limits	Units	MILLIMETERS		
		MIN	NOM	MAX
Number of Pins	N	14		
Pitch	e	0.65 BSC		
Overall Height	A	-	-	1.20
Molded Package Thickness	A2	0.80	1.00	1.05
Standoff	A1	0.05	-	0.15
Overall Width	E	6.40 BSC		
Molded Package Width	E1	4.30	4.40	4.50
Molded Package Length	D	4.90	5.00	5.10
Foot Length	L	0.45	0.60	0.75
Footprint	(L1)	1.00 REF		
Foot Angle	$\varphi$	0°	-	8°
Lead Thickness	c	0.09	-	0.20
Lead Width	b	0.19	-	0.30

**Notes:**

1. Pin 1 visual index feature may vary, but must be located within the hatched area.
2. Dimensions D and E1 do not include mold flash or protrusions. Mold flash or protrusions shall not exceed 0.15mm per side.
3. Dimensioning and tolerancing per ASME Y14.5M

BSC: Basic Dimension. Theoretically exact value shown without tolerances.

REF: Reference Dimension, usually without tolerance, for information purposes only.

Microchip Technology Drawing No. C04-087C Sheet 2 of 2

# MCP795W1X/MCP795W2X

## 14-Lead Plastic Thin Shrink Small Outline (ST) - 4.4 mm Body [TSSOP]

**Note:** For the most current package drawings, please see the Microchip Packaging Specification located at <http://www.microchip.com/packaging>

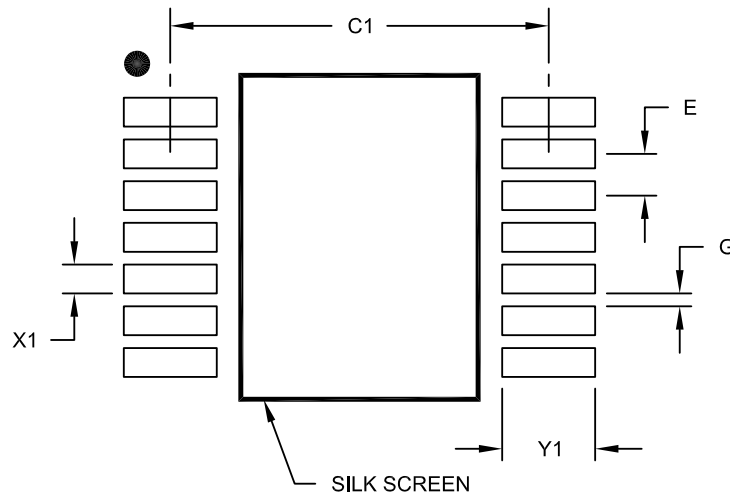

RECOMMENDED LAND PATTERN

Dimension Limits	Units	MILLIMETERS		
		MIN	NOM	MAX
Contact Pitch	E	0.65 BSC		
Contact Pad Spacing	C1		5.90	
Contact Pad Width (X14)	X1			0.45
Contact Pad Length (X14)	Y1			1.45
Distance Between Pads	G	0.20		

**Notes:**

1. Dimensioning and tolerancing per ASME Y14.5M

BSC: Basic Dimension. Theoretically exact value shown without tolerances.

Microchip Technology Drawing No. C04-2087A

## APPENDIX A: REVISION HISTORY

### Revision A (11/2011)

Initial Release.

### Revision B (03/2012)

Added detailed descriptions for Registers.

### Revision C (06/2012)

Downgraded data sheet for 3V operation.

# MCP795W1X/MCP795W2X

---

NOTES:



## THE MICROCHIP WEB SITE

Microchip provides online support via our WWW site at [www.microchip.com](http://www.microchip.com). This web site is used as a means to make files and information easily available to customers. Accessible by using your favorite Internet browser, the web site contains the following information:

- **Product Support** – Data sheets and errata, application notes and sample programs, design resources, user's guides and hardware support documents, latest software releases and archived software
- **General Technical Support** – Frequently Asked Questions (FAQ), technical support requests, online discussion groups, Microchip consultant program member listing
- **Business of Microchip** – Product selector and ordering guides, latest Microchip press releases, listing of seminars and events, listings of Microchip sales offices, distributors and factory representatives

## CUSTOMER CHANGE NOTIFICATION SERVICE

Microchip's customer notification service helps keep customers current on Microchip products. Subscribers will receive e-mail notification whenever there are changes, updates, revisions or errata related to a specified product family or development tool of interest.

To register, access the Microchip web site at [www.microchip.com](http://www.microchip.com). Under "Support", click on "Customer Change Notification" and follow the registration s.

## CUSTOMER SUPPORT

Users of Microchip products can receive assistance through several channels:

- Distributor or Representative
- Local Sales Office
- Field Application Engineer (FAE)
- Technical Support
- Development Systems Information Line

Customers should contact their distributor, representative or field application engineer (FAE) for support. Local sales offices are also available to help customers. A listing of sales offices and locations is included in the back of this document.

**Technical support is available through the web site at: <http://microchip.com/support>**

# MCP795W1X/MCP795W2X

---

---

## READER RESPONSE

It is our intention to provide you with the best documentation possible to ensure successful use of your Microchip product. If you wish to provide your comments on organization, clarity, subject matter, and ways in which our documentation can better serve you, please FAX your comments to the Technical Publications Manager at (480) 792-4150.

Please list the following information, and use this outline to provide us with your comments about this document.

TO: Technical Publications Manager Total Pages Sent \_\_\_\_\_

RE: Reader Response

From: Name \_\_\_\_\_

Company \_\_\_\_\_

Address \_\_\_\_\_

City / State / ZIP / Country \_\_\_\_\_

Telephone: (\_\_\_\_\_) \_\_\_\_\_ - \_\_\_\_\_ FAX: (\_\_\_\_\_) \_\_\_\_\_ - \_\_\_\_\_

Application (optional):

Would you like a reply?  Y  N

Device: MCP795W1X/MCP795W2X

Literature Number: DS22280C

Questions:

1. What are the best features of this document?

\_\_\_\_\_  
\_\_\_\_\_

2. How does this document meet your hardware and software development needs?

\_\_\_\_\_  
\_\_\_\_\_

3. Do you find the organization of this document easy to follow? If not, why?

\_\_\_\_\_  
\_\_\_\_\_

4. What additions to the document do you think would enhance the structure and subject?

\_\_\_\_\_  
\_\_\_\_\_

5. What deletions from the document could be made without affecting the overall usefulness?

\_\_\_\_\_  
\_\_\_\_\_

6. Is there any incorrect or misleading information (what and where)?

\_\_\_\_\_  
\_\_\_\_\_

7. How would you improve this document?

\_\_\_\_\_  
\_\_\_\_\_

# MCP795W1X/MCP795W2X

## PRODUCT IDENTIFICATION SYSTEM

To order or obtain information, e.g., on pricing or delivery, refer to the factory or the listed sales office. Not every possible ordering combination is listed below.

<u>MCP795</u>	<u>W</u>	<u>1</u>	<u>0</u>	<u>T</u>	<u>-</u>	<u>I</u>	<u>/SL</u>														
Base Part	Additional Features	Memory	Unique ID	T/R	Temp Range		Package														
<table border="1"> <tr> <td><b>Base Part No.:</b></td> <td>MCP795 = SPI RTCC</td> </tr> <tr> <td><b>Additional Features:</b></td> <td>Blank = None W = Watchdog Timer, 2 Event Detects</td> </tr> <tr> <td><b>Memory:</b></td> <td>1 = 1 Kbit EE, 64 Bytes SRAM 2 = 2 Kbits EE, 64 Bytes SRAM</td> </tr> <tr> <td><b>ID/MAC Address:</b></td> <td>0 = Blank 1 = EUI-48™ MAC Address 2 = EUI-64™ MAC Address</td> </tr> <tr> <td><b>T/R:</b></td> <td>Blank = Tube T = Tape and Reel</td> </tr> <tr> <td><b>Temperature Range:</b></td> <td>I = -40°C to +85°C</td> </tr> <tr> <td><b>Package:</b></td> <td>SL = 14-Pin SOIC ST = 14-Pin TSSOP</td> </tr> </table>								<b>Base Part No.:</b>	MCP795 = SPI RTCC	<b>Additional Features:</b>	Blank = None W = Watchdog Timer, 2 Event Detects	<b>Memory:</b>	1 = 1 Kbit EE, 64 Bytes SRAM 2 = 2 Kbits EE, 64 Bytes SRAM	<b>ID/MAC Address:</b>	0 = Blank 1 = EUI-48™ MAC Address 2 = EUI-64™ MAC Address	<b>T/R:</b>	Blank = Tube T = Tape and Reel	<b>Temperature Range:</b>	I = -40°C to +85°C	<b>Package:</b>	SL = 14-Pin SOIC ST = 14-Pin TSSOP
<b>Base Part No.:</b>	MCP795 = SPI RTCC																				
<b>Additional Features:</b>	Blank = None W = Watchdog Timer, 2 Event Detects																				
<b>Memory:</b>	1 = 1 Kbit EE, 64 Bytes SRAM 2 = 2 Kbits EE, 64 Bytes SRAM																				
<b>ID/MAC Address:</b>	0 = Blank 1 = EUI-48™ MAC Address 2 = EUI-64™ MAC Address																				
<b>T/R:</b>	Blank = Tube T = Tape and Reel																				
<b>Temperature Range:</b>	I = -40°C to +85°C																				
<b>Package:</b>	SL = 14-Pin SOIC ST = 14-Pin TSSOP																				
<p><b>Examples:</b></p> <ul style="list-style-type: none"> <li>a) MCP795W20-I/SL: 2K EEPROM, Blank ID, Industrial Temperature, SOIC Package</li> <li>b) MCP795W10-I/ST: 1K EEPROM, Blank ID, Industrial Temperature, TSSOP Package</li> <li>c) MCP795W21-I/SL: 2K EEPROM, EUI-48™, Industrial Temperature, SOIC Package</li> <li>d) MCP795W22-I/ST: 2K EEPROM, EUI-64™, Industrial Temperature, TSSOP Package</li> </ul> <p><b>Note 1:</b> All devices include a Watchdog Timer and two Event Detects.</p>																					

# MCP795W1X/MCP795W2X

---

NOTES:

---

**Note the following details of the code protection feature on Microchip devices:**

- Microchip products meet the specification contained in their particular Microchip Data Sheet.
- Microchip believes that its family of products is one of the most secure families of its kind on the market today, when used in the intended manner and under normal conditions.
- There are dishonest and possibly illegal methods used to breach the code protection feature. All of these methods, to our knowledge, require using the Microchip products in a manner outside the operating specifications contained in Microchip's Data Sheets. Most likely, the person doing so is engaged in theft of intellectual property.
- Microchip is willing to work with the customer who is concerned about the integrity of their code.
- Neither Microchip nor any other semiconductor manufacturer can guarantee the security of their code. Code protection does not mean that we are guaranteeing the product as “unbreakable.”

Code protection is constantly evolving. We at Microchip are committed to continuously improving the code protection features of our products. Attempts to break Microchip's code protection feature may be a violation of the Digital Millennium Copyright Act. If such acts allow unauthorized access to your software or other copyrighted work, you may have a right to sue for relief under that Act.

---

Information contained in this publication regarding device applications and the like is provided only for your convenience and may be superseded by updates. It is your responsibility to ensure that your application meets with your specifications. MICROCHIP MAKES NO REPRESENTATIONS OR WARRANTIES OF ANY KIND WHETHER EXPRESS OR IMPLIED, WRITTEN OR ORAL, STATUTORY OR OTHERWISE, RELATED TO THE INFORMATION, INCLUDING BUT NOT LIMITED TO ITS CONDITION, QUALITY, PERFORMANCE, MERCHANTABILITY OR FITNESS FOR PURPOSE. Microchip disclaims all liability arising from this information and its use. Use of Microchip devices in life support and/or safety applications is entirely at the buyer's risk, and the buyer agrees to defend, indemnify and hold harmless Microchip from any and all damages, claims, suits, or expenses resulting from such use. No licenses are conveyed, implicitly or otherwise, under any Microchip intellectual property rights.

**Trademarks**

The Microchip name and logo, the Microchip logo, dsPIC, KEELOQ, KEELOQ logo, MPLAB, PIC, PICmicro, PICSTART, PIC<sup>32</sup> logo, rPIC and UNI/O are registered trademarks of Microchip Technology Incorporated in the U.S.A. and other countries.

FilterLab, Hampshire, HI-TECH C, Linear Active Thermistor, MXDEV, MXLAB, SEEVAL and The Embedded Control Solutions Company are registered trademarks of Microchip Technology Incorporated in the U.S.A.

Analog-for-the-Digital Age, Application Maestro, chipKIT, chipKIT logo, CodeGuard, dsPICDEM, dsPICDEM.net, dsPICworks, dsSPEAK, ECAN, ECONOMONITOR, FanSense, HI-TIDE, In-Circuit Serial Programming, ICSP, Mindi, MiWi, MPASM, MPLAB Certified logo, MPLIB, MPLINK, mTouch, Omniscient Code Generation, PICC, PICC-18, PICDEM, PICDEM.net, PICKit, PICtail, REAL ICE, rLAB, Select Mode, Total Endurance, TSHARC, UniWinDriver, WiperLock and ZENA are trademarks of Microchip Technology Incorporated in the U.S.A. and other countries.

SQTP is a service mark of Microchip Technology Incorporated in the U.S.A.

All other trademarks mentioned herein are property of their respective companies.

© 2011-2012, Microchip Technology Incorporated, Printed in the U.S.A., All Rights Reserved.

 Printed on recycled paper.

ISBN: 9781620763797

*Microchip received ISO/TS-16949:2009 certification for its worldwide headquarters, design and wafer fabrication facilities in Chandler and Tempe, Arizona; Gresham, Oregon and design centers in California and India. The Company's quality system processes and procedures are for its PIC<sup>®</sup> MCUs and dsPIC<sup>®</sup> DSCs, KEELOQ<sup>®</sup> code hopping devices, Serial EEPROMs, microperipherals, nonvolatile memory and analog products. In addition, Microchip's quality system for the design and manufacture of development systems is ISO 9001:2000 certified.*

**QUALITY MANAGEMENT SYSTEM  
CERTIFIED BY DNV  
= ISO/TS 16949 =**



# MICROCHIP

## Worldwide Sales and Service

### AMERICAS

**Corporate Office**  
2355 West Chandler Blvd.  
Chandler, AZ 85224-6199  
Tel: 480-792-7200  
Fax: 480-792-7277  
Technical Support:  
<http://www.microchip.com/support>  
Web Address:  
[www.microchip.com](http://www.microchip.com)

**Atlanta**  
Duluth, GA  
Tel: 678-957-9614  
Fax: 678-957-1455

**Boston**  
Westborough, MA  
Tel: 774-760-0087  
Fax: 774-760-0088

**Chicago**  
Itasca, IL  
Tel: 630-285-0071  
Fax: 630-285-0075

**Cleveland**  
Independence, OH  
Tel: 216-447-0464  
Fax: 216-447-0643

**Dallas**  
Addison, TX  
Tel: 972-818-7423  
Fax: 972-818-2924

**Detroit**  
Farmington Hills, MI  
Tel: 248-538-2250  
Fax: 248-538-2260

**Indianapolis**  
Noblesville, IN  
Tel: 317-773-8323  
Fax: 317-773-5453

**Los Angeles**  
Mission Viejo, CA  
Tel: 949-462-9523  
Fax: 949-462-9608

**Santa Clara**  
Santa Clara, CA  
Tel: 408-961-6444  
Fax: 408-961-6445

**Toronto**  
Mississauga, Ontario,  
Canada  
Tel: 905-673-0699  
Fax: 905-673-6509

### ASIA/PACIFIC

**Asia Pacific Office**  
Suites 3707-14, 37th Floor  
Tower 6, The Gateway  
Harbour City, Kowloon  
Hong Kong  
Tel: 852-2401-1200  
Fax: 852-2401-3431

**Australia - Sydney**  
Tel: 61-2-9868-6733  
Fax: 61-2-9868-6755

**China - Beijing**  
Tel: 86-10-8569-7000  
Fax: 86-10-8528-2104

**China - Chengdu**  
Tel: 86-28-8665-5511  
Fax: 86-28-8665-7889

**China - Chongqing**  
Tel: 86-23-8980-9588  
Fax: 86-23-8980-9500

**China - Hangzhou**  
Tel: 86-571-2819-3187  
Fax: 86-571-2819-3189

**China - Hong Kong SAR**  
Tel: 852-2401-1200  
Fax: 852-2401-3431

**China - Nanjing**  
Tel: 86-25-8473-2460  
Fax: 86-25-8473-2470

**China - Qingdao**  
Tel: 86-532-8502-7355  
Fax: 86-532-8502-7205

**China - Shanghai**  
Tel: 86-21-5407-5533  
Fax: 86-21-5407-5066

**China - Shenyang**  
Tel: 86-24-2334-2829  
Fax: 86-24-2334-2393

**China - Shenzhen**  
Tel: 86-755-8203-2660  
Fax: 86-755-8203-1760

**China - Wuhan**  
Tel: 86-27-5980-5300  
Fax: 86-27-5980-5118

**China - Xian**  
Tel: 86-29-8833-7252  
Fax: 86-29-8833-7256

**China - Xiamen**  
Tel: 86-592-2388138  
Fax: 86-592-2388130

**China - Zhuhai**  
Tel: 86-756-3210040  
Fax: 86-756-3210049

### ASIA/PACIFIC

**India - Bangalore**  
Tel: 91-80-3090-4444  
Fax: 91-80-3090-4123

**India - New Delhi**  
Tel: 91-11-4160-8631  
Fax: 91-11-4160-8632

**India - Pune**  
Tel: 91-20-2566-1512  
Fax: 91-20-2566-1513

**Japan - Osaka**  
Tel: 81-66-152-7160  
Fax: 81-66-152-9310

**Japan - Yokohama**  
Tel: 81-45-471-6166  
Fax: 81-45-471-6122

**Korea - Daegu**  
Tel: 82-53-744-4301  
Fax: 82-53-744-4302

**Korea - Seoul**  
Tel: 82-2-554-7200  
Fax: 82-2-558-5932 or  
82-2-558-5934

**Malaysia - Kuala Lumpur**  
Tel: 60-3-6201-9857  
Fax: 60-3-6201-9859

**Malaysia - Penang**  
Tel: 60-4-227-8870  
Fax: 60-4-227-4068

**Philippines - Manila**  
Tel: 63-2-634-9065  
Fax: 63-2-634-9069

**Singapore**  
Tel: 65-6334-8870  
Fax: 65-6334-8850

**Taiwan - Hsin Chu**  
Tel: 886-3-5778-366  
Fax: 886-3-5770-955

**Taiwan - Kaohsiung**  
Tel: 886-7-536-4818  
Fax: 886-7-330-9305

**Taiwan - Taipei**  
Tel: 886-2-2500-6610  
Fax: 886-2-2508-0102

**Thailand - Bangkok**  
Tel: 66-2-694-1351  
Fax: 66-2-694-1350

### EUROPE

**Austria - Wels**  
Tel: 43-7242-2244-39  
Fax: 43-7242-2244-393

**Denmark - Copenhagen**  
Tel: 45-4450-2828  
Fax: 45-4485-2829

**France - Paris**  
Tel: 33-1-69-53-63-20  
Fax: 33-1-69-30-90-79

**Germany - Munich**  
Tel: 49-89-627-144-0  
Fax: 49-89-627-144-44

**Italy - Milan**  
Tel: 39-0331-742611  
Fax: 39-0331-466781

**Netherlands - Drunen**  
Tel: 31-416-690399  
Fax: 31-416-690340

**Spain - Madrid**  
Tel: 34-91-708-08-90  
Fax: 34-91-708-08-91

**UK - Wokingham**  
Tel: 44-118-921-5869  
Fax: 44-118-921-5820

11/29/11

## Данный компонент на территории Российской Федерации

### Вы можете приобрести в компании MosChip.

Для оперативного оформления запроса Вам необходимо перейти по данной ссылке:

<http://moschip.ru/get-element>

Вы можете разместить у нас заказ для любого Вашего проекта, будь то серийное производство или разработка единичного прибора.

В нашем ассортименте представлены ведущие мировые производители активных и пассивных электронных компонентов.

Нашей специализацией является поставка электронной компонентной базы двойного назначения, продукции таких производителей как XILINX, Intel (ex.ALTERA), Vicor, Microchip, Texas Instruments, Analog Devices, Mini-Circuits, Amphenol, Glenair.

Сотрудничество с глобальными дистрибьюторами электронных компонентов, предоставляет возможность заказывать и получать с международных складов практически любой перечень компонентов в оптимальные для Вас сроки.

На всех этапах разработки и производства наши партнеры могут получить квалифицированную поддержку опытных инженеров.

Система менеджмента качества компании отвечает требованиям в соответствии с ГОСТ Р ИСО 9001, ГОСТ РВ 0015-002 и ЭС РД 009

### Офис по работе с юридическими лицами:

105318, г.Москва, ул.Щербаковская д.3, офис 1107, 1118, ДЦ «Щербаковский»

Телефон: +7 495 668-12-70 (многоканальный)

Факс: +7 495 668-12-70 (доб.304)

E-mail: [info@moschip.ru](mailto:info@moschip.ru)

Skype отдела продаж:

moschip.ru

moschip.ru\_4

moschip.ru\_6

moschip.ru\_9