

Type 2 surge protection device - VAL-MS 750/30/3+0-FM - 2920272

Please be informed that the data shown in this PDF Document is generated from our Online Catalog. Please find the complete data in the user's documentation. Our General Terms of Use for Downloads are valid (<http://phoenixcontact.com/download>)



Surge arrester for 4-conductor power supply systems (L1, L2, L3, PEN), consisting of a base element with remote indication contact and protective connectors, for mounting on NS 35.

Product Features

- ✓ Other solutions for power supplies UN = 400 V available on request
- ✓ For power supplies with higher supply voltages
- ✓ Use in powerful industrial networks and wind power plants



Key commercial data

Packing unit	1 pc
Weight per Piece (excluding packing)	420.0 GRM
Custom tariff number	85363030
Country of origin	Germany

Technical data

Dimensions

Height	99 mm
Width	53.4 mm
Depth	58 mm
Horizontal pitch	3 Div.

Ambient conditions

Degree of protection	IP20 (only when all terminal points are used)
Ambient temperature (operation)	-40 °C ... 80 °C
Ambient temperature (storage/transport)	-40 °C ... 80 °C
Altitude	≤ 2000 m (amsl (above mean sea level))

Type 2 surge protection device - VAL-MS 750/30/3+0-FM - 2920272

Technical data

Ambient conditions

Permissible humidity (operation)	5 % ... 95 %
Shock (operation)	25g
Vibration (operation)	5g

General

Standards/specifications	IEC 61643-11 2011
	EN 61643-11 2012
IEC test classification	II
	T2
EN type	T2
IEC power supply system	TN-C
	IT (please see note below)
Number of ports	One
SPD design	Voltage-limiting type
Mode of protection	L-PEN
	L-PE
Mounting type	DIN rail: 35 mm
Color	black
Housing material	PA 6.6
	PBT
Pollution degree	2
Distance between live and grounded parts	8 mm
Inflammability class according to UL 94	V-0
Type	DIN rail module, two-section, divisible
Number of positions	3
Surge protection fault message	Optical, remote indicator contact

Additional descriptions

Note	Usable in all low-voltage systems between L-N or L-PEN. Only usable in IT Systems between L-PE, if the exposed-conductive-parts (bodies) of the equipment of the low-voltage installation is connected to the earthing arrangement of the transformer substation. (interconnected earthing arrangement of the HV-transformer substation with the bodies of the LV-installation. $R_E = R_A$ accordance to IEC 60364-4-442 / VDE 0100-442 Fig. 44D / Example a)
------	--

Protective circuit

Nominal voltage U_N	554/960 V AC (TN-C)
	690 V AC (IT)
Nominal frequency f_N	50 Hz (60 Hz)
Maximum continuous operating voltage U_C (L-PE)	760 V AC

Type 2 surge protection device - VAL-MS 750/30/3+0-FM - 2920272

Technical data

Protective circuit

Maximum continuous operating voltage U_C (L-PEN)	760 V AC
Rated load current I_L	80 A
Residual current I_{PE}	≤ 1.5 mA
Standby power consumption P_C	≤ 1200 mVA
Nominal discharge current I_n (8/20) μ s (L-PE)	15 kA
Nominal discharge current I_n (8/20) μ s (L-PEN)	15 kA
Maximum discharge current I_{max} (8/20) μ s (L-PE)	30 kA
Maximum discharge current I_{max} (8/20) μ s (L-PEN)	30 kA
Short-circuit current rating I_{SCCR}	25 kA
Voltage protection level U_p (L-PE)	≤ 2.9 kV
Voltage protection level U_p (L-PEN)	≤ 2.9 kV
Residual voltage U_{res} (L-PE)	≤ 2.9 kV (at I_n)
	≤ 2.7 kV (at 10 kA)
	≤ 2.5 kV (at 5 kA)
	≤ 2.3 kV (at 3 kA)
Residual voltage U_{res} (L-PEN)	≤ 2.9 kV (at I_n)
	≤ 2.7 kV (at 10 kA)
	≤ 2.5 kV (at 5 kA)
	≤ 2.3 kV (at 3 kA)
TOV behavior at U_T (L-PEN)	1000 V AC (5 s / withstand mode)
Response time t_A (L-PE)	≤ 25 ns
Response time t_A (L-PEN)	≤ 25 ns
Max. backup fuse with branch wiring	100 A AC (gG)
Max. backup fuse with V-type through wiring	80 A AC (gG)

Indicator/remote signaling

Connection name	Remote fault indicator contact
Switching function	PDT contact
Operating voltage	5 V AC ... 250 V AC
	125 V AC (UL)
	30 V DC
Operating current	5 mA AC ... 1.5 A AC
	1 A AC (UL)
	1 A DC
Connection method	Screw connection
Screw thread	M2
Tightening torque	0.25 Nm

Type 2 surge protection device - VAL-MS 750/30/3+0-FM - 2920272

Technical data

Indicator/remote signaling

	4 lb _r -in. (UL)
Stripping length	7 mm
Conductor cross section stranded min.	0.14 mm ²
Conductor cross section stranded max.	1.5 mm ²
Conductor cross section solid min.	0.14 mm ²
Conductor cross section solid max.	1.5 mm ²
AWG conductor cross section	28 ... 16
	30 ... 14 (UL)

Connection data

Connection method	Screw connection
Conductor cross section stranded min.	1.5 mm ²
Conductor cross section stranded max.	25 mm ²
Conductor cross section solid min.	1.5 mm ²
Conductor cross section solid max.	35 mm ²
AWG conductor cross section	15 ... 2
	10 ... 2 (UL)
Screw thread	M5
Tightening torque	4.5 Nm
	30 lb _r -in. (UL)
Stripping length	16 mm

UL specifications

UL class	Type 4 SPD for Type 2 applications
Maximum continuous operating voltage MCOV (L-G)	750 V AC
Nom. voltage	690 V AC
Mode of protection	L-L
	L-G
Power distribution system	3D
Nominal frequency	50/60 Hz
Voltage protection rating VPR (L-L)	4 kV
Voltage protection rating VPR (L-G)	2.5 kV
Nominal discharge current I _n (L-L)	10 kA
Nominal discharge current I _n (L-G)	10 kA

Type 2 surge protection device - VAL-MS 750/30/3+0-FM - 2920272

Classifications

eCl@ss

eCl@ss 4.0	27140201
eCl@ss 4.1	27130801
eCl@ss 5.0	27130801
eCl@ss 5.1	27130801
eCl@ss 6.0	27130805
eCl@ss 7.0	27130805
eCl@ss 8.0	27130805

ETIM

ETIM 2.0	EC000941
ETIM 3.0	EC000941
ETIM 4.0	EC000941
ETIM 5.0	EC000941

UNSPSC

UNSPSC 6.01	30212010
UNSPSC 7.0901	39121610
UNSPSC 11	39121610
UNSPSC 12.01	39121610
UNSPSC 13.2	39121620

Approvals

Approvals

Approvals

UL Recognized / KEMA-KEUR / ÖVE / cUL Recognized / GOST / GL / CCA / IECCEB Scheme / KEMA-KEUR / ÖVE / cULus Recognized

Ex Approvals

Approvals submitted

Approval details

Type 2 surge protection device - VAL-MS 750/30/3+0-FM - 2920272

Approvals

UL Recognized 

KEMA-KEUR 

ÖVE 

cUL Recognized 

GOST 

GL

CCA

IECEE CB Scheme 

KEMA-KEUR 

ÖVE 

cULus Recognized 

Type 2 surge protection device - VAL-MS 750/30/3+0-FM - 2920272

Drawings

Dimensioned drawing

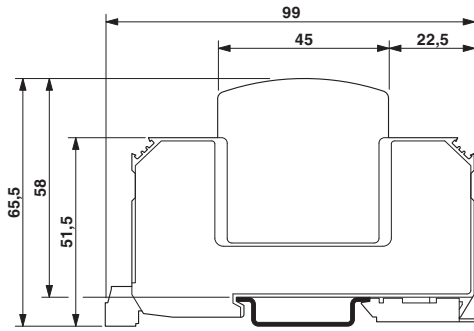

Circuit diagram

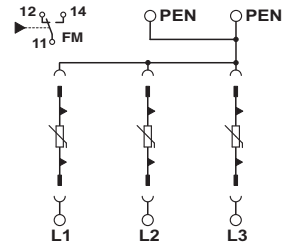

Application drawing

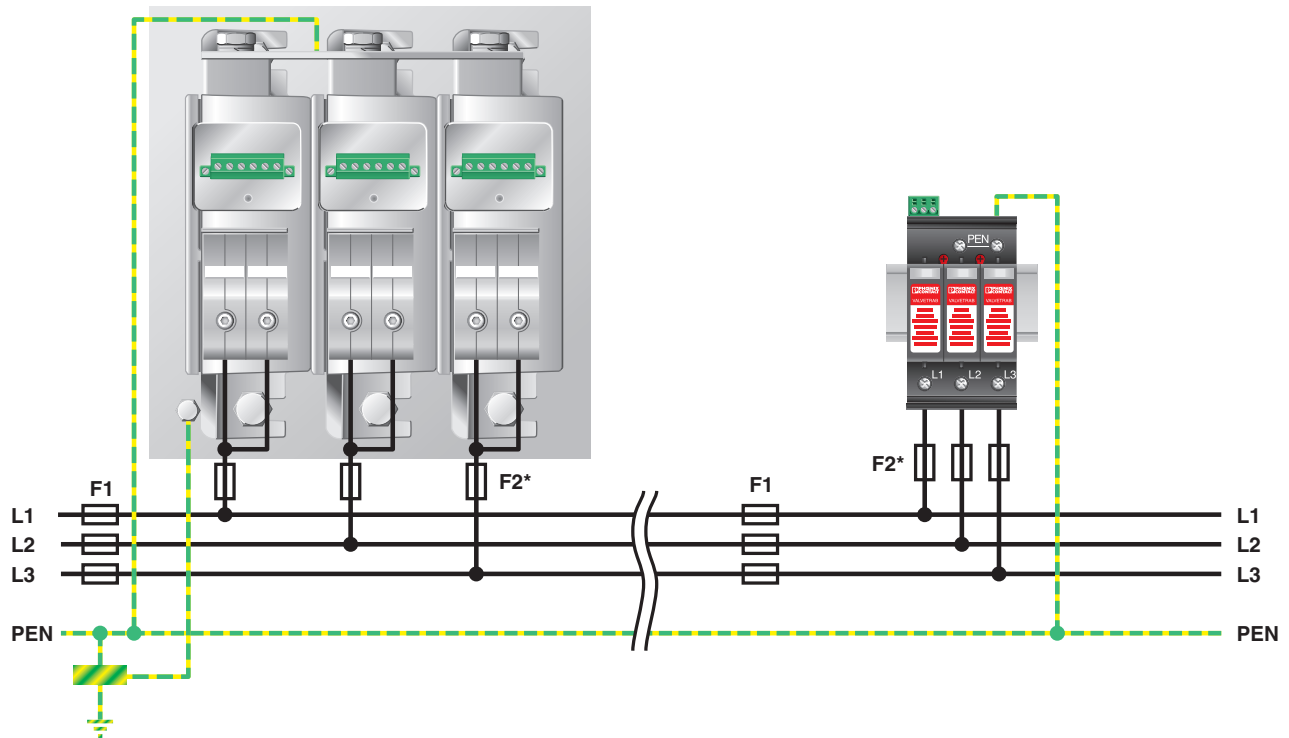

Type 2 surge protection device - VAL-MS 750/30/3+0-FM - 2920272

Application drawing

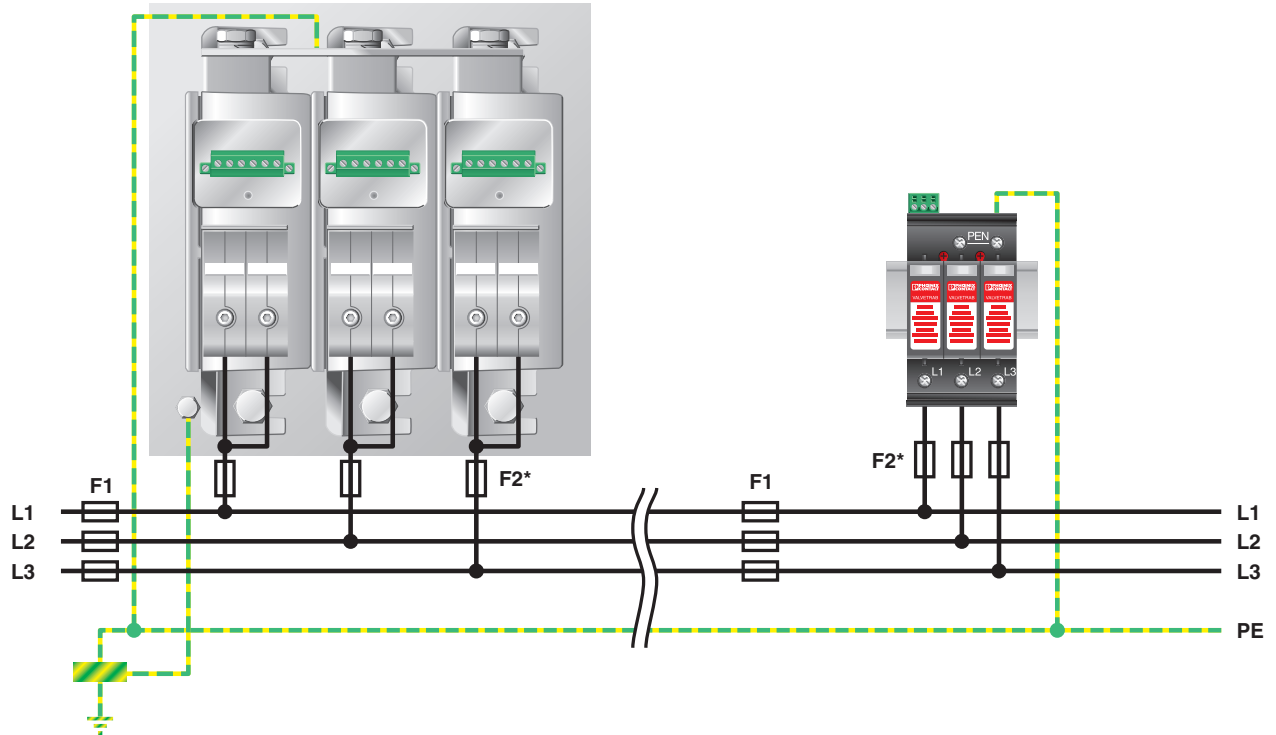

Данный компонент на территории Российской Федерации

Вы можете приобрести в компании MosChip.

Для оперативного оформления запроса Вам необходимо перейти по данной ссылке:

<http://moschip.ru/get-element>

Вы можете разместить у нас заказ для любого Вашего проекта, будь то серийное производство или разработка единичного прибора.

В нашем ассортименте представлены ведущие мировые производители активных и пассивных электронных компонентов.

Нашей специализацией является поставка электронной компонентной базы двойного назначения, продукции таких производителей как XILINX, Intel (ex.ALTERA), Vicor, Microchip, Texas Instruments, Analog Devices, Mini-Circuits, Amphenol, Glenair.

Сотрудничество с глобальными дистрибьюторами электронных компонентов, предоставляет возможность заказывать и получать с международных складов практически любой перечень компонентов в оптимальные для Вас сроки.

На всех этапах разработки и производства наши партнеры могут получить квалифицированную поддержку опытных инженеров.

Система менеджмента качества компании отвечает требованиям в соответствии с ГОСТ Р ИСО 9001, ГОСТ РВ 0015-002 и ЭС РД 009

Офис по работе с юридическими лицами:

105318, г.Москва, ул.Щербаковская д.3, офис 1107, 1118, ДЦ «Щербаковский»

Телефон: +7 495 668-12-70 (многоканальный)

Факс: +7 495 668-12-70 (доб.304)

E-mail: info@moschip.ru

Skype отдела продаж:

moschip.ru

moschip.ru_4

moschip.ru_6

moschip.ru_9