

MCR-S-...-DCI

**Current transducer up to 55 A,
programmable and configurable**

Data sheet
100241_en_11

© PHOENIX CONTACT 2012-06-07



1 Description

The **MCR-S-...-DCI** current transducers offer users the option of ordering a preconfigured device, configuring the device themselves via DIP switches or programming it with MCR/PI-CONF-WIN configuration software (Order No. 2814799).



The MCR-S-1-5-UI-DCI module provides not only the standard 1 A and 5 A input signals, but also the option of setting current ranges of 0 ... 0.2 A to 0 ... 11 A progressively.

With a measuring range of 0 ... 9.5 A to 0 ... 55 A, the MCR-S-10-50-UI-DCI is ideal for measuring higher motor currents.

DC, AC, and distorted currents can be equally well measured.

In addition to an analog output, these current transducers also have an optional relay and transistor output, e.g., for alarm monitoring.

When ordering, the desired configuration to which the device is to be adapted must be specified (see order key on page 6 and page 9).

Features

- Progressive adjustment of measuring range
- True r.m.s. value measurement
- 3-way electrical isolation according to EN 61010
- With optional relay and transistor output
- 22.5 mm ME housing



Observe the safety notes on page 11.



Make sure you always use the latest documentation.

It can be downloaded from the product at www.phoenixcontact.net/catalog.



This data sheet is valid for the products listed on the following page:

2 Table of contents

1	Description.....	1
2	Table of contents	2
3	Ordering data.....	3
4	Technical data	4
4.1	Technical data for MCR-S-1-5-UI(-SW)-DCI(-NC) (measuring range 0 A ... 0.2 A to 0 A ... 11 A)	4
4.2	Technical data for MCR-S-10-50-UI(-SW)-DCI(-NC) (measuring range 0 A ... 9.5 A to 0 A ... 55 A)	7
5	Design	10
6	Installation and startup.....	11
6.1	Safety notes	11
6.2	Method of operation	11
6.3	Electrical connection	11
6.4	Startup.....	12
6.5	Configuration flowchart.....	12
7	Software package (adapter)	18
8	Application examples.....	19
8.1	Motor current measurement	19
8.2	Acquisition of motor current peak loads.....	19
8.3	Lighting monitoring	19

3 Ordering data

MCR current transducer, for measuring AC, DC, and distorted Currents

Description	Type	Order No.	Pcs./Pkt.
Measuring range 0 A ... 0.2 A to 0 A ... 11 A			
Configured, with screw connection	MCR-S-1-5-UI-DCI ¹	2814634	1
Unconfigured, with screw connection	MCR-S-1-5-UI-DCI-NC	2814715	1
Measuring range 0 A ... 0.2 A to 0 A ... 11 A, with relay and transistor output			
Configured, with screw connection	MCR-S-1-5-UI-SW-DCI ¹	2814650	1
Unconfigured, with screw connection	MCR-S-1-5-UI-SW-DCI-NC	2814731	1
Measuring range 0 A ... 9.5 A to 0 A ... 55 A			
Configured, with through connection	MCR-S-10-50-UI-DCI ¹	2814647	1
Unconfigured, with through connection	MCR-S10-50-UI-DCI-NC	2814728	1
Measuring range 0 A ... 9.5 A to 0 A ... 55 A, with relay and transistor switching output			
Configured, with through connection	MCR-S-10-50-UI-SW-DCI ¹	2814663	1
Unconfigured, with through connection	MCR-S10-50-UI-SW-DCI-NC	2814744	1

¹ If no further details are given as to the configuration, the device is supplied in the standard configuration (see order key on page page 6 and page 9).

Accessories

Description	Type	Order No.	Pcs./Pkt.
Configuration software	MCR/PI-CONF-WIN	2814799	1
Software adapter cable (stereo jack connector/25-pos. D-SUB) 1.2 m	MCR-TTL/RS232-E	2814388	1
Adapter cable, 9-pos. D-SUB female connector to 25-pos. D-SUB male connector	PSM-KAD 9 SUB 25/BS	2761295	1

4 Technical data

4.1 Technical data for MCR-S-1-5-UI(-SW)-DCI(-NC) (measuring range 0 A ... 0.2 A to 0 A ... 11 A)

Measuring input	MCR-S-1-5-UI-DCI (-NC)	MCR-S-1-5-UI-SW-DCI (-NC)
Input current (AC, DC or distorted currents)	0 A ... 11 A	
Frequency range	15 Hz ... 400 Hz	
Connection method	Screw terminal block 2.5 mm ²	
Overload capacity, continuous	2 x I _{Nom}	
Surge strength for 1 s	20 x I _{Nom} (100 A, maximum)	
Output	MCR-S-1-5-UI-DCI (-NC)	MCR-S-1-5-UI-SW-DCI (-NC)
Output current/load	0(4) mA ... 20 mA, 20 mA ... 0(4) mA / < 500 Ω	
Output voltage/load	0(2) V ... 10 V, 10 V ... 0(2) V / > 10 kΩ 0(1) V ... 5 V, 5 V ... 0(1) V / > 10 kΩ ±10 V, ± 5 V / > 10 kΩ	
Switching output	MCR-S-1-5-UI-DCI (-NC)	MCR-S-1-5-UI-SW-DCI (-NC)
Relay Output	-	1 PDT
Contact material		AgSnO ₂ , hard gold-plated
Max. switching voltage		30 V AC / 36 V DC
Continuous current load capacity		50 mA
 If the specified maximum values are exceeded, the gold coating will be damaged. In subsequent operation, the following maximum switching voltages and currents apply: 250 V AC/DC; 2A.		
Transistor output	MCR-S-1-5-UI-DCI (-NC)	MCR-S-1-5-UI-SW-DCI (-NC)
Maximum transistor current	-	PNP output 80 mA (not short-circuit-proof)
Output voltage during event	-	1 V under supply voltage
Threshold setting	-	1 % ... 110 %
Suppression time	-	0.1 s ... 20 s
Threshold value switch status indicator	-	Yellow LED
General data	MCR-S-1-5-UI-DCI (-NC)	MCR-S-1-5-UI-SW-DCI (-NC)
Supply voltage	20 V DC ... 30 V DC	
Current consumption (without load)	Approximately 40 mA	Approximately 50 mA
Transmission error of nominal value under nominal conditions:	< 0.5 %	
Measuring range nominal value:	0 A ... 1 A/5 A/10 A	
operate threshold from measuring range nominal value	2 %	
Input signal form:	50 Hz - sine	
Measurement mode:	true r.m.s. value	
Ambient temperature:	23 °C	
Supply voltage:	24 V DC	
Temperature coefficient	< 0.025%/K	
Measuring rate	40 measurements/s with DC 5 measurements/s with AC	
Step response (10% ... 90 %)	40 ms with DC 330 ms with DC	
Safe isolation according to EN 50178, EN 61010	300 V AC to ground (suitable for measuring in 400 V AC three-phase networks)	
Input/output (analog), input/output (relay), input/output (transistor), input/supply		

General data (continued)	MCR-S-1-5-UI-DCI (-NC)	MCR-S-1-5-UI-SW-DCI (-NC)
Test voltage		
Input/output (analog), input/output (relay), input/output (transistor), input/supply		4 kV, 50 Hz, 1 min.
Output (analog)/output (relay), output (relay)/output (transistor)		4 kV, 50 Hz, 1 min.
Output (analog)/output (transistor), output (analog)/supply		500 V, 50 Hz, 1 min.
Ambient temperature (operation)		-20 °C ... 60 °C
Ambient temperature (storage/transport)		-40 °C ... 85 °C
Module warm-up time		≥ 2 min.
Supply voltage status indicator		Green LED
Degree of protection		IP20
Mounting position		Any
Mounting		Any
Dimensions (W x H x D)		22.5 mm x 99 mm x 114.5 mm
Housing material		Polyamide PA, non-reinforced

Approvals

CE

CE

UL



PROCESS CONTROL EQUIPMENT FOR HAZARDOUS LOCATIONS 31ZN

CI. I Zn. 2, AEx nC IIC T6 / Ex nC IIC T6

CI. I Div. 2, Groups A, B, C and D

A) This equipment is suitable for use in Class 1, Division 2, Groups A, B, C and D or non-hazardous locations only.

B) Warning - explosion hazard - substitution of components may impair suitability for Class 1, Division 2.

C) Warning - explosion hazard - do not disconnect equipment unless power has been switched off or the area is known to be non-hazardous.

Conformance with EMC Directive 2004/108/EC and Low Voltage Directive 2006/95/EC

Noise immunity test according to EN 61000-6-2¹

Electrostatic discharge (ESD)	EN 61000-4-2	Criterion B ²	8 kV air discharge
Electromagnetic HF field	EN 61000-4-3	Criterion A ³	10 V/m
Fast transients (burst)	EN 61000-4-4	Criterion B ²	
Input/output/power supply			2 kV / 5 kHz
Surge current load (surge)	EN 61000-4-5	Criterion B ²	
Input/output			2 kV / 42 Ω
Supply			1 kV / 2 Ω
Conducted interference	EN 61000-4-6	Criterion A ³	
Input/output/power supply			10 V

Noise emission test according to EN 61000-6-4

Noise emission of housing	EN 55011 ⁴	Class A ⁵
---------------------------	-----------------------	----------------------

¹ EN 61000 corresponds to IEC 61000

² Criterion B: Temporary adverse effects on the operating behavior, which the device corrects automatically.

³ Criterion A: Normal operating behavior within the specified limits.

⁴ EN 55011 corresponds to CISPR11

⁵ Class A: Industrial application, without special installation measures.

Order Key for the MCR-S-1-5-UI(-SW)-DCI Current Transducer

If incorrect or no customer order information is given, the standard configuration is delivered (shown as an example in the ordering key).

Order No.	Measuring Range Start Value	Measuring Range Final Value	Output signal
2814634	0.00	5.00	OUT01
MCR-S-1-5-UI-DCI	0 A ... 7.5 A 0.00 = 0 A	0.2 A ... 11 A 5.00 = 5 A	OUT01 = 0 mA ... 20 mA OUT02 = 4 mA ... 20 mA OUT03 = 0 V ... 10 V OUT04 = 2 V ... 10 V OUT05 = 0 V ... 5 V OUT06 = 1 V ... 5 V OUT13 = -5 V ... +5 V OUT14 = -10 V ... +10 V

Order No.	Measuring RangeStart Value	Measuring Range Final Value	Output signal	Threshold value	Suppression time	Switching behavior of relay and transistor	
2814650	0.00	5.00	OUT01	50	3.0	A	O
MCR-S-1-5-UI-SWI-DCI	0 A ... 7.5 A 0.00 = 0 A	0.2 A ... 11 A 5.00 = 5 A	OUT01 = 0 mA ... 20 mA OUT02 = 4 mA ... 20 mA OUT03 = 0 V ... 10 V OUT04 = 2 V ... 10 V OUT05 = 0 V ... 5 V OUT06 = 1 V ... 5 V OUT13 = -5 V ... +5 V OUT14 = -10 V ... +10 V	1 % ... 110 % 50 = 50 % of the set measuring range final value (here: 2.5 A)	0.1 s ... 20 s 3.0 = 3 s	A = operating current-controlled R = Closed circuit current-controlled	O = Above U = Below

4.2 Technical data for MCR-S-10-50-UI(-SW)-DCI(-NC) (measuring range 0 A ... 9.5 A to 0 A ... 55 A)

Measuring input	MCR-S-10-50-UI-DCI (-NC)	MCR-S-10-50-UI-SW-DCI (-NC)
Input current (AC, DC or distorted currents)	0 A ... 55 A (freely adjustable)	
Frequency range	15 Hz ... 400 Hz	
Connection method	Through connection 10.5 mm Ø	
Overload capacity, continuous	Depends on the conductor	
Current carrying capacity for 1 s	Depends on the conductor	
Output	MCR-S-10-50-UI-DCI (-NC)	MCR-S-10-50-UI-SW-DCI (-NC)
Output current/load	0(4) mA ... 20 mA, 20 mA ... 0(4) mA / < 500 Ω	
Output voltage/load	0(2) V ... 10 V, 10 V ... 0(2) V / > 10 kΩ 0(1) V ... 5 V, 5 V ... 0(1) V / > 10 kΩ ±10 V, ± 5 V / > 10 kΩ	
Switching output	MCR-S-10-50-UI-DCI (-NC)	MCR-S-10-50-UI-SW-DCI (-NC)
Relay Output	-	1 PDT
Contact material		AgSnO ₂ , hard gold-plated
Max. switching voltage		30 V AC / 36 V DC
Continuous current load capacity		50 mA
	If the specified maximum values are exceeded, the gold coating will be damaged. In subsequent operation, the following maximum switching voltages and currents apply: 250 V AC/DC; 2A.	
Transistor output	-	PNP output
Maximum transistor current		80 mA (not short-circuit-proof)
Output voltage during event		1 V under supply voltage
Threshold setting	-	1 % ... 110 %
Suppression time	-	0.1 s ... 20 s
Threshold value switch status indicator	-	Yellow LED
General data	MCR-S-10-50-UI-DCI (-NC)	MCR-S-10-50-UI-SW-DCI (-NC)
Supply voltage:	20 V DC ... 30 V DC	
Current consumption (without load)	Approximately 40 mA	Approximately 50 mA
Current consumption (with transistor switching output: max. 80 mA)	Approximately 120 mA	Approximately 130 mA
Transmission error of nominal value under nominal conditions:	< 0.5 %	
Measuring range nominal value:	0 A ... 50 A	
operate threshold from measuring range nominal value	0.8 %	
Input signal form:	50 Hz - sine	
Measurement mode:	true r.m.s. value	
Ambient temperature:	23 °C	
Supply voltage:	24 V DC	
Temperature coefficient	< 0.025%/K	
Measuring rate	40 measurements/s with DC 5 measurements/s with AC	
Step response (10% ... 90 %)	40 ms with DC 330 ms with AC	
Safe isolation according to EN 50178, EN 61010	300 V AC to ground (suitable for measuring in 400 V AC three-phase networks)	

General data (continued)	MCR-S-10-50-UI-DCI (-NC)	MCR-S-10-50-UI-SW-DCI (-NC)
Test voltage		
Input/output (analog), input/output (relay), input/output (transistor), input/supply		4 kV, 50 Hz, 1 min.
Output (analog)/output (relay), output (relay)/output (transistor)		4 kV, 50 Hz, 1 min.
Output (analog)/output (transistor), output (analog)/supply		500 V, 50 Hz, 1 min.
Ambient temperature (operation)		-20 °C ... 60 °C
Ambient temperature (storage/transport)		-40 °C ... 85 °C
Module warm-up time		≥ 2 min.
Supply voltage status indicator		Green LED
Degree of protection		IP20
Mounting position		Any
Mounting		Any
Dimensions (W x H x D)		22.5 mm x 99 mm x 114.5 mm
Housing material		Polyamide PA, non-reinforced

Approvals

CE

CE

UL

**PROCESS CONTROL EQUIPMENT FOR HAZARDOUS
LOCATIONS 31ZN**
Cl. I, Zn. 2, AEx nC IIC T6 / Ex nC IIC T6
Cl. I Div. 2, Groups A, B, C and D

 A) This equipment is suitable for use in Class 1, Division 2,
Groups A, B, C and D or non-hazardous locations only.

 B) Warning - explosion hazard - substitution of components may impair
suitability for Class 1, Division 2.

 C) Warning - explosion hazard - do not disconnect equipment unless
power has been switched off or the area is known to be non-hazardous.

Conformance with EMC Directive 2004/108/EG and Low Voltage Directive 2006/95/EG

Noise immunity test according to EN 61000-6-2¹

Electrostatic discharge (ESD)	EN 61000-4-2	Criterion B ²	8 kV air discharge
Electromagnetic HF field	EN 61000-4-3	Criterion A ³	10 V/m
Fast transients (burst)	EN 61000-4-4	Criterion B ²	
Input/output/power supply			2 kV / 5 kHz
Surge current load (surge)	EN 61000-4-5	Criterion B ²	
Input/output			2 kV / 42 Ω
Supply			1 kV / 2 Ω
Conducted interference	EN 61000-4-6	Criterion A ³	
Input/output/power supply			10 V

Noise emission test according to EN 61000-6-4

Noise emission of housing	EN 55011 ⁴	Class A ⁵
---------------------------	-----------------------	----------------------

¹ EN 61000 corresponds to IEC 61000

² Criterion B: Temporary adverse effects on the operating behavior, which the device corrects automatically.

³ Criterion A: Normal operating behavior within the specified limits.

⁴ EN 55011 corresponds to CISPR11

⁵ Class A: Industrial application, without special installation measures.

Order Key for the MCR-S-10-50-UI(-SW)-DCI current transducer

If incorrect or no customer order information is given, the standard configuration is delivered (shown as an example in the ordering key).

Order No.	Measuring range start value	Measuring range final value	Output signal
2814647	0.0	50.0	OUT01
MCR-S-10-50-UI-DCI	0 A ... 37.5 A 0.0 = 0 A	9.5 A ... 55 A 50.0 = 50 A	OUT01 = 0 mA ... 20 mA OUT02 = 4 mA ... 20 mA OUT03 = 0 V ... 10 V OUT04 = 2 V ... 10 V OUT05 = 0 V ... 5 V OUT06 = 1 V ... 5 V OUT13 = -5 V ... +5 V OUT14 = -10 V ... +10 V

Order No.	Measuring range start value	Measuring range final value	Output signal	Threshold value	Suppression time	Switching behavior of relay and transistor	
2814663	0.0	50.0	OUT01	50	3.0	A	O
MCR-S-10-50-UI-SWI-DCI	0 A ... 37.5 A 0.0 = 0 A	9.5 A ... 55 A 50.0 = 50 A	OUT01 = 0 mA ... 20 mA OUT02 = 4 mA ... 20 mA OUT03 = 0 V ... 10 V OUT04 = 2 V ... 10 V OUT05 = 0 V ... 5 V OUT06 = 1 V ... 5 V OUT13 = -5 V ... +5 V OUT14 = -10 V ... +10 V	1 % ... 110 % 50 = 50 % of the set measuring range final value (here: 25 A)	0.1 s ... 20 s 3.0 = 3 s	A = Operating current-controlled R = Closed circuit current-controlled O = Above U = Below	

5 Design



Figure 1 Structure using the example of the MCR-S-...-UI-SW-DCI(-NC) current transducer with relay and transistor output

- 1 Metal lock for mounting on the DIN rail
- 2 Upper part of housing slides open for DIP switch setting
- 3 Programming interface
- 4 TIME potentiometer for threshold value suppression time (only for MCR-S-...-UI-SW-DCI(-NC))
- 5 "SW" LED (yellow): Threshold value switch (only for MCR-S-...-UI-SW-DCI(-NC))
- 6 "POWER" LED (green): Supply voltage
- 7 ZERO/SPAN potentiometer
- 8 Threshold value potentiometer (only for MCR-S-...-UI-SW-DCI(-NC))

i The potentiometers on the front should only be adjusted using a screwdriver, which is safely isolated from the voltage at the input.

- 9 Cable feed-through (only for MCR-S-10-50-UI(-SW)-DCI(-NC))

6 Installation and startup

6.1 Safety notes



During operation, certain parts of this electric measuring transducer may carry hazardous voltages. Disregarding this warning may result in serious personal injury or damage to property.

MCR-S-...-DCI Modules must only be installed and started by qualified personnel.

Qualified personnel are people who, because of their education, experience and instruction and their knowledge of relevant standards, regulations, accident prevention and service conditions, have been authorized by those responsible for the safety of the plant, to carry out any required operations and who are able to recognize and avoid any possible dangers.



The transducer must not be started up when the housing is open.



The potentiometers on the front should only be adjusted using a screwdriver, which is safely isolated from the voltage at the input.



For applications with high operating voltages, ensure sufficient distance or insulation and provide shock protection.

Safe and error-free operation of this device can only be ensured if transport, storage, and assembly are carried out correctly and operation and maintenance are carried out with care.

6.2 Method of operation

Connection to the input terminal blocks (MCR-S-1-5-...-DCI) or passing the live conductor through the current transducer (MCR-S-10-50-...-DCI) induces a magnetic flux in the strip-wound core. The magnetic flux density is measured using a Hall sensor and converted proportionally from the input current to a voltage (Hall voltage). A subsequent true r.m.s. value converter enables DC, AC, and distorted currents to be measured. The signal is amplified for further processing and made available as a proportional analog signal at the output.

6.3 Electrical connection



When operating this electric measuring transducer, the national regulations (e.g., in Germany, VDE 0100 "Conditions for the Erection of Electrical Power Installations with Nominal Voltages Below 1000 V") must be observed during the installation and selection of the electrical conductors.

Pin assignment

Connection terminal block	Description
1	(12) N/C contact ¹
2	(11) Center contact ¹
3	(14) N/O contact ¹
4	Not used
5	10 A input ²
6	5 A input ²
7	1 A input ²
8	Reference ground for 1, 5, and 10 A input ²
9	Current output
10	Voltage output
11	Reference ground for current or voltage output
12	Reference ground for current or voltage output
13	Operating voltage (+24 V DC)
14	Reference ground for operating voltage
15	Transistor output ¹
16	Reference ground for transistor output ¹

¹ Only for MCR-S-...-SW-DCI(-NC)

² Only for MCR-S-1-5-(-SW)-DCI(-NC)

6.4 Startup

Before starting up the measuring transducer, please ensure that the module configuration data matches the measuring requirements. The configuration data for a preconfigured device can be found on the right hand side of the housing.

If you are using an unconfigured transducer, there is a standard configuration which can be found in the order keys on page 6 and page 9. If the desired configuration does not match the label on the side of the housing or the standard configuration, refer to the section below.

6.5 Configuration flowchart

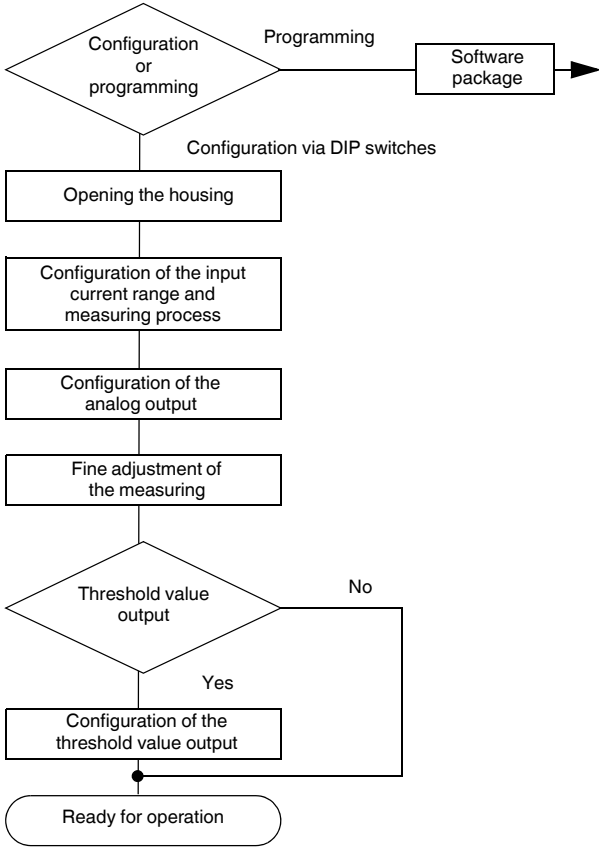

Figure 2 Configuration flowchart

6.5.1 Configuration or programming

The MCR-S-...-DCI generation offers the advantage of a choice between configuration and programming. MCR/PI-CONF-WIN software can be used to freely program the true r.m.s. value current transducer.

Programming is explained in the software manual. The user-friendly configuration software runs under all popular Windows operating systems.

In addition to programming, modules can be parameterized using DIP switches and potentiometers.

The rest of this section deals with configuration:

6.5.2 Opening the housing

i The transducer must not be started up when the housing is open.

Release the locked upper part of the housing on both sides with the help of a screwdriver. The upper part of the housing and the electronics can now be pulled out approximately 3 cm.

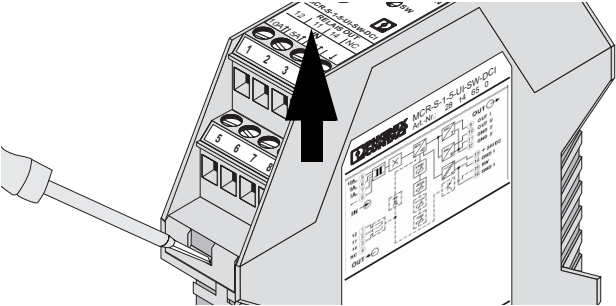

Figure 3 Opening the housing

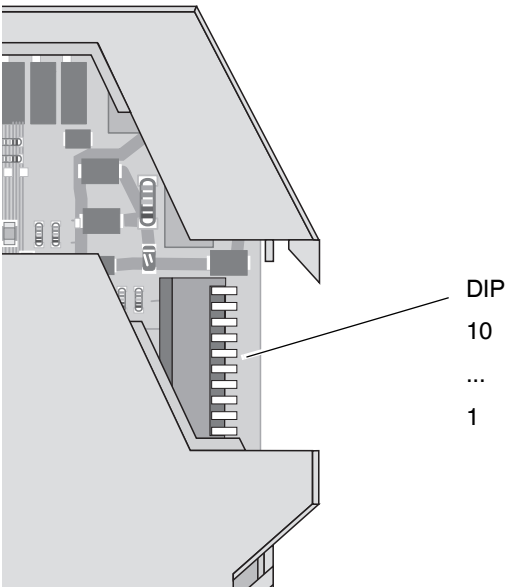

Figure 4 DIP switches

DIP	Description
10	Configuration via DIP switches/ programming via software
9	Input current measurement: True r.m.s. value/arithmic average value
8	Operating current/closed circuit current behavior ¹
7	Above threshold value/ Below threshold value ¹
6	Setting the analog output signal
5	
4	
3	
2	Setting the input measuring range
1	

¹ Only for MCR-S-...-SW-DCI(-NC)

Setting DIP switch 10 to configuration mode (**DIP switch 10** to "OFF") switches all potentiometers to "active".

DIP 10	Description
OFF	Configuration via DIP switches
ON	Programming via software (DIP switches 1 to 9 and potentiometer settings not relevant)

6.5.3 Configuration of the input current range and measuring process

(Rough setting via DIP switches)

Use DIP switch 9 to select the measuring process (true r.m.s. value or arithmetic average value).

DIP 9	Description
OFF	True r.m.s. value (AC and DC without without sign bitdetection)
ON	Arithmetic average value (DC with sign bitdetection)

True r.m.s. value: The true r.m.s. value of an AC current corresponds by definition to the steady-state value that results from the instantaneous values of this current. This steady-state value generates the same thermal work in an ohmic resistor as a DC current of identical magnitude. The term "true r.m.s. value" simply indicates that distorted and pulsating currents are also measured.

Arithmetic average value: The arithmetic average value is used to measure DC currents or to filter a DC portion from a pulsating current. Using the arithmetic average value on a symmetrical AC current would result in the measured value being "0".

The arithmetic average value can be used to make bipolar DC currents available as analog standard signals at the output.

MCR-S-1-5-...DCI: Optimum use of the measuring ranges

SPAN potentiometer -25%	Nominal range ¹	SPAN potentiometer +25%	DIP 1	DIP 2
1 A input: Measuring range: 0 A ... 0.18 A to 0 A ... 1.1 A				
0 A ... 0.75 A	0 A ... 1.00 A	0 A ... 1.10 A	OFF	OFF
0 A ... 0.48 A	0 A ... 0.65 A	0 A ... 0.81 A	OFF	ON
0 A ... 0.30 A	0 A ... 0.40 A	0 A ... 0.50 A	ON	OFF
0 A ... 0.18 A	0 A ... 0.25 A	0 A ... 0.31 A	ON	ON
5 A input: Measuring range: 0 ... 0.94 A to 0 ... 5.5 A				
0 A ... 3.75 A	0 A ... 5.00 A	0 A ... 5.50 A	OFF	OFF
0 A ... 2.43 A	0 A ... 3.25 A	0 A ... 4.06 A	OFF	ON
0 A ... 1.50 A	0 A ... 2.00 A	0 A ... 2.50 A	ON	OFF
0 A ... 0.94 A	0 A ... 1.25 A	0 A ... 1.56 A	ON	ON
10 A input: Measuring range: 0 ... 4.87 A to 0 ... 11 A				
0 A ... 7.50 A	0 A ... 10.0 A	0 A ... 11.00 A	OFF	OFF
0 A ... 4.87 A	0 A ... 6.5 A	0 A ... 8.12 A	OFF	ON

¹ The nominal range is adapted

MCR-S-10-50-...DCI: Optimum use of the measuring range

SPAN potentiometer -25%	Nominal range ¹	SPAN potentiometer +25%	DIP 1	DIP 2
Measuring range: 0 A ... 9.38 A to 0 A ... 55 A				
0 A ... 37.5 A	0 A ... 50.0 A	0 A ... 55.0 A	OFF	OFF
0 A ... 24.4 A	0 A ... 32.5 A	0 A ... 40.6 A	OFF	ON
0 A ... 15.0 A	0 A ... 20.0 A	0 A ... 25.0 A	ON	OFF
0 A ... 9.38 A	0 A ... 12.5 A	0 A ... 15.6 A	ON	ON

¹ The nominal range is adapted

6.5.4 Configuration of the analog output

Output	DIP 3	DIP 4	DIP 5	DIP 6
0 mA ... 20 mA	OFF	OFF	OFF	OFF
20 mA ... 0 mA	OFF	OFF	OFF	ON
4 mA ... 20 mA	OFF	OFF	ON	OFF
20 mA ... 4 mA	OFF	OFF	ON	ON
0 V ... 10 V	OFF	ON	OFF	OFF
10 V ... 0 V	OFF	ON	OFF	ON
0 V ... 5 V	OFF	ON	ON	OFF
5 V ... 0 V	OFF	ON	ON	ON
1 V ... 5 V	ON	OFF	ON	OFF
5 V ... 1 V	ON	OFF	ON	ON
-10 V ... 10 V	ON	ON	OFF	OFF
10 V ... -10 V	ON	ON	OFF	ON
-5 V ... 5 V	ON	ON	ON	OFF
5 V ... -5 V	ON	ON	ON	ON

6.5.5 Configuration of the Threshold Value Output

The relay and transistor output of the threshold value versions (MCR-S-...-SW-DCI) are set after the input measuring range and the analog output have been adapted.

Setting the switching threshold

The diagrams below (Figure 5 to Figure 8 on page 15) illustrate the four possible switching behavior options for the relay and transistor output. The various options for the operating behavior in threshold value mode are divided according to:

- Operating current or closed circuit current principle
- Threshold value triggered when value is below threshold
- Value is above threshold value

If necessary, the corresponding switching behavior can be set via DIP switch 7 and DIP switch 8.

DIP 7	DIP 8	Switching Behavior of Relay and Transistor Output	See
OFF	OFF	Operating current-controlled when above threshold value	Figure 5
ON	OFF	Operating current-controlled when below threshold value	Figure 6
OFF	ON	Closed circuit current-controlled when above threshold value	Figure 7
ON	ON	Closed circuit current-controlled when below threshold value	Figure 8

Switching behavior of relay and transistor output for the current transducer



Figure 5 Function diagram: Operating current-controlled when above threshold value

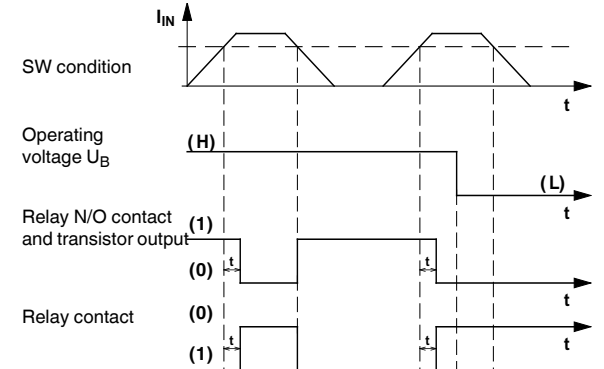

Figure 6 Function diagram: Closed circuit current-controlled when above threshold value

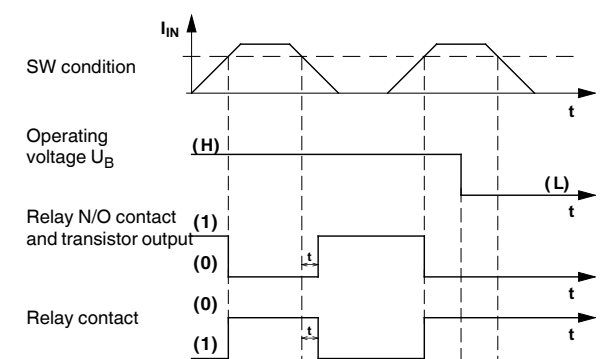

Figure 7 Function diagram: Operating current-controlled when below threshold value

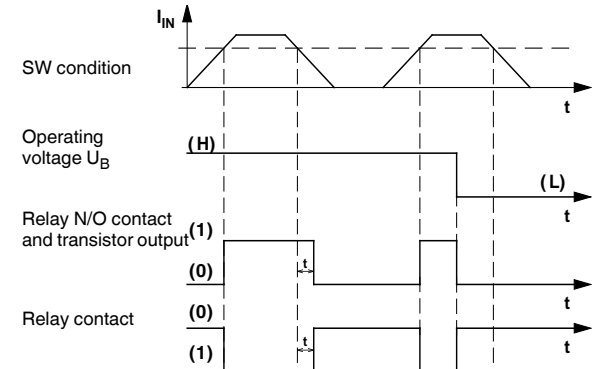

Figure 8 Function diagram: Closed circuit current-controlled when below threshold value

(0) = N/O contact and transistor open, N/C contact closed, LED off
 (1) = N/O contact and transistor closed, N/C contact open, LED on

t₁ can be set via software and potentiometer

Fine adjustment of the measuring transducer

- Close the module after roughly setting the input current range and preselecting the output signal.
- Connect the module to the signal lines and the operating voltage according to the instructions in "Electrical connection" on page 11.

When the green "POWER" LED is lit, the operating voltage of 20 V DC ... 30 V DC is connected.

i When using the MCR-S-...-DCI, ensure you use the correct signal input terminal block for your measuring range.

Signal input range	Signal input terminal block	Ground terminal block
1 A	7	8
5 A	6	8
10 A	5	8

i Allow the module to warm up for 2 minutes before starting the adjustment procedure.

Analog Output

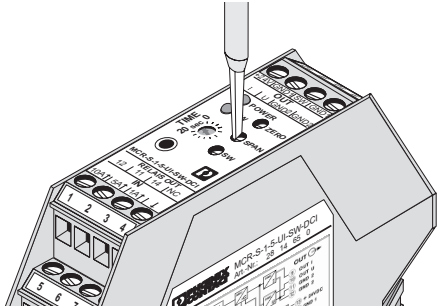

Figure 9 Potentiometers

ZERO and SPAN behavior ($\pm 25\%$ each) are shown in Figure 10 and Figure 11:

- ZERO potentiometer for zero point adjustment
- SPAN potentiometer for final value adjustment

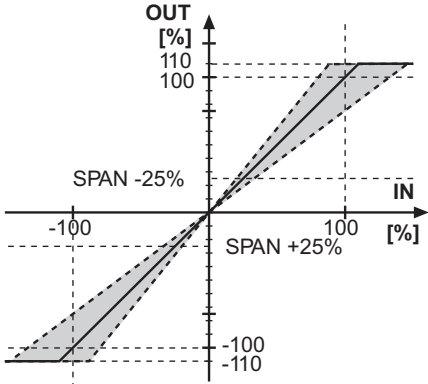

Figure 10 Offset (ZERO) behavior

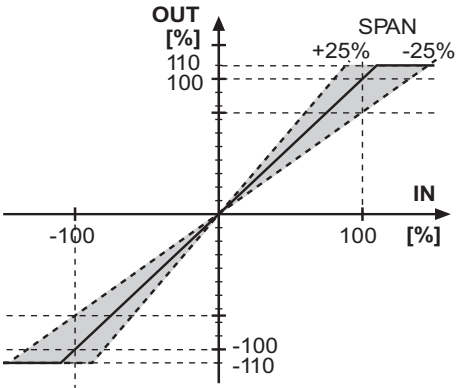

Figure 11 Final value (SPAN) behavior

7 Software package (adapter)



As an alternative to setting via DIP switches, the module can be programmed using the MCR/PI-CONF-WIN configuration software (Order No. 2814799).

Software features

- All configuration parameters can be entered in the computer
- The parameters entered in the computer can be saved to the measuring transducer
- The parameters available in the module can be exported
- The parameters can be saved to a drive of your choice
- A side-panel label can be created
- The programmed module parameters can be printed
- Bar graph display
- Monitoring function

The MCR-TTL/RS232-E software adapter cable (Order No. 2814388) can be used to connect the computer and the current transducer. This cable has a stereo jack connector on one end for connection to the current transducer and a 25-pos. D-SUB female connector on the other end for connection to a computer. For connection to the computer, an adapter cable for the interface converter is usually required (9-pos. D-SUB female connector to 25-pos. D-SUB male connector, Order No. 2761295).

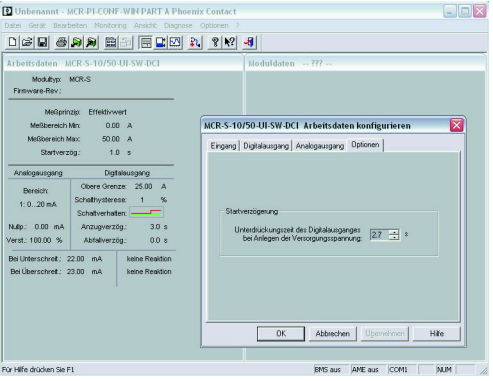
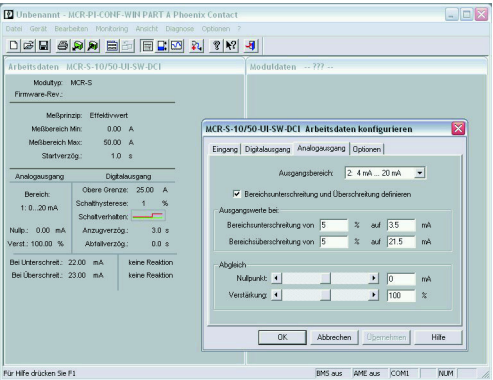
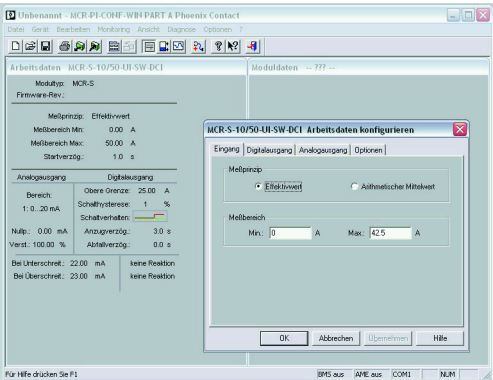
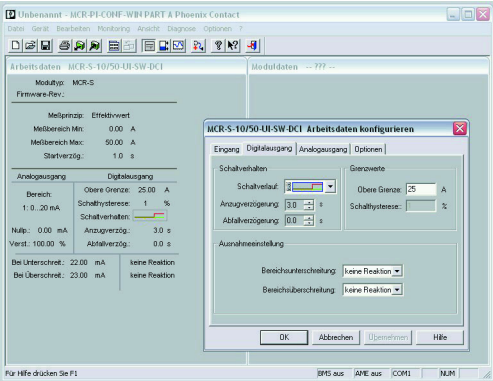

8 Application examples

8.1 Motor current measurement

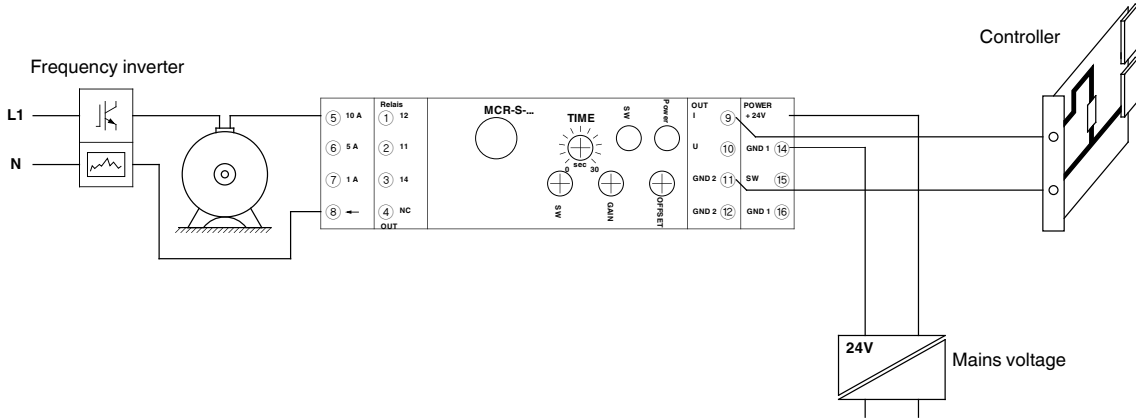

Figure 13 Motor current measurement

The use of MCR-S-...-DCI modules in one or more supply phases of the motor enables what is known as "motor monitoring" (Figure 13). The MCR current transducer can transfer corresponding standard signals about the motor load to the control system or service personnel. The true r.m.s. value measurement process means that AC, DC, and distorted currents can be measured. Even higher frequency currents up to 1 kHz can be acquired.

8.2 Acquisition of motor current peak loads

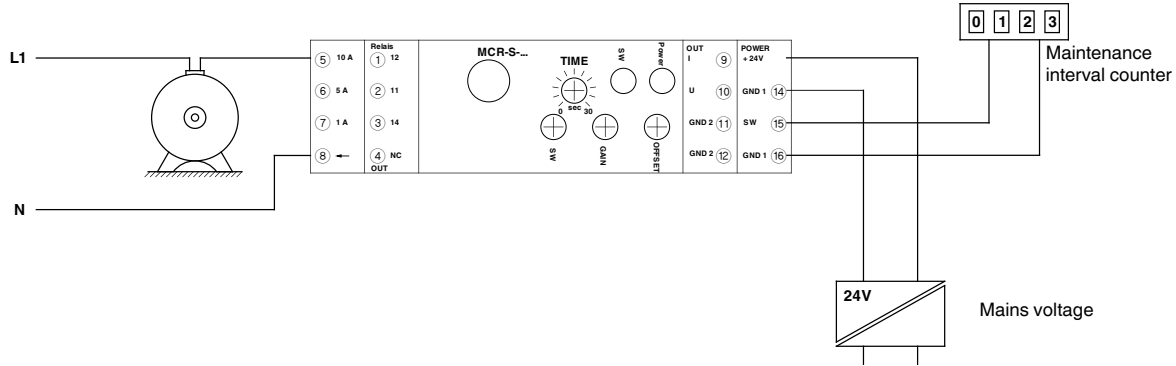

Figure 14 Acquisition of motor current peak loads

Large industrial motors must be overhauled and serviced at regular intervals. Installing an MCR current transducer in one phase of the motor feed line enables pulses to be generated with the relay or transistor switching output that can be measured using a simple meter (Figure 14). The service personnel can then use the motor starts and peak loads as a basis to provide efficient maintenance corresponding to the number of overloads.

8.3 Lighting monitoring

MCR current transducers can be used for monitoring lighting. If the strength of the current in a circuit is above or below a specified value after a suppressed switch-on time, there is a fault in the lighting circuit. If the lighting circuit fails, this signal status can be passed on to another control unit and the emergency lighting can be switched on. The same method can also be used with other power loads.

Данный компонент на территории Российской Федерации

Вы можете приобрести в компании MosChip.

Для оперативного оформления запроса Вам необходимо перейти по данной ссылке:

<http://moschip.ru/get-element>

Вы можете разместить у нас заказ для любого Вашего проекта, будь то серийное производство или разработка единичного прибора.

В нашем ассортименте представлены ведущие мировые производители активных и пассивных электронных компонентов.

Нашей специализацией является поставка электронной компонентной базы двойного назначения, продукции таких производителей как XILINX, Intel (ex.ALTERA), Vicor, Microchip, Texas Instruments, Analog Devices, Mini-Circuits, Amphenol, Glenair.

Сотрудничество с глобальными дистрибьюторами электронных компонентов, предоставляет возможность заказывать и получать с международных складов практически любой перечень компонентов в оптимальные для Вас сроки.

На всех этапах разработки и производства наши партнеры могут получить квалифицированную поддержку опытных инженеров.

Система менеджмента качества компании отвечает требованиям в соответствии с ГОСТ Р ИСО 9001, ГОСТ РВ 0015-002 и ЭС РД 009

Офис по работе с юридическими лицами:

105318, г.Москва, ул.Щербаковская д.3, офис 1107, 1118, ДЦ «Щербаковский»

Телефон: +7 495 668-12-70 (многоканальный)

Факс: +7 495 668-12-70 (доб.304)

E-mail: info@moschip.ru

Skype отдела продаж:

moschip.ru

moschip.ru_4

moschip.ru_6

moschip.ru_9