

# FEATURES SELECTION GUIDE



CIRCUIT SIZE	FEATURES						SHEET NO
	FRICTION LOCKS		SIDE SLOTS		⑤ CENTER POLARIZATION	⑥ PEG	
	① DUAL	② CENTER	③ DUAL	④ SINGLE			
4	N.A	N.A	YES	N.A	N.A	N.A	2 - 3
	N.A	YES	YES	N.A	N.A	N.A	
	N.A	YES	N.A	YES	N.A	N.A	
6	N.A	N.A	YES	N.A	N.A	N.A	4 - 5
	N.A	N.A	YES	N.A	N.A	YES	
	N.A	YES	YES	N.A	N.A	N.A	
	N.A	YES	YES	N.A	N.A	YES	
	N.A	YES	N.A	YES	N.A	YES	
	N.A	YES	N.A	YES	N.A	YES	
	N.A	N.A	YES	N.A	YES	N.A	
8 TO 12	N.A	N.A	YES	N.A	YES	N.A	6 - 8
	N.A	N.A	YES	N.A	YES	YES	
	N.A	YES	YES	N.A	N.A	N.A	
	N.A	YES	YES	N.A	N.A	YES	
	N.A	YES	N.A	YES	N.A	N.A	
	N.A	YES	N.A	YES	N.A	YES	
14 TO 50	YES	N.A	YES	N.A	YES	N.A	9 - 13
	YES	N.A	YES	N.A	YES	YES	

<b>RELEASED</b> EC NO: S2015-1188 DRWNG: GMENARLY 2015/04/15 CHK'D: CGOH 2015/06/29 APPR: KHL IM 2015/06/29	QUALITY SYMBOLS	GENERAL TOLERANCES (UNLESS SPECIFIED)	DIMENSION STYLE	SCALE	DESIGN UNITS	THIRD ANGLE PROJECTION
	$\nabla_{\text{A}} = 0$ $\nabla_{\text{C}} = 0$ $\nabla_{\text{P}} = 0$	mm INCH	MM ONLY	NTS	METRIC	
		4 PLACES ± --- ± --- 3 PLACES ± --- ± --- 2 PLACES ± 0.20 ± --- 1 PLACE ± --- ± --- 0 PLACE ± --- ± ---	DRAWN BY DATE GMENARLY 2015/04/15 CHECKED BY DATE	TITLE MILLIGRID 2MM PITCH, THROUGH HOLE VERTICAL SHROUDED HEADER		
		ANGULAR ± 3 ° DRAFT WHERE APPLICABLE MUST REMAIN WITHIN DIMENSIONS	APPROVED BY DATE KHL IM 2015/06/29 MATERIAL NO. <b>SEE TABLE</b>	DOCUMENT NO. <b>SD-87831-0001</b>		SHEET NO. 1 OF 13

4 CIRCUITS

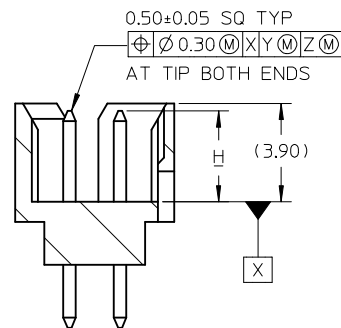
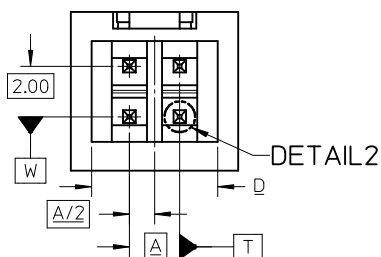
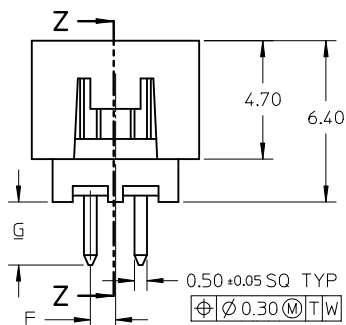
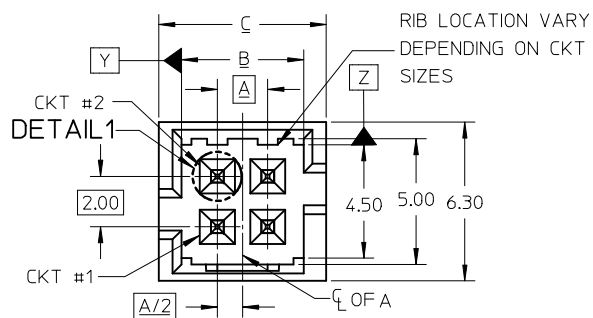

SECTION Z-Z

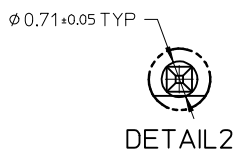
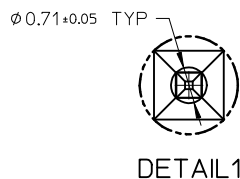

DETAIL1

DETAIL2

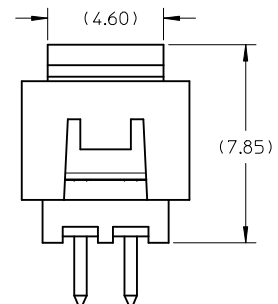

VIEW FOR  
HEADER WITH CAP

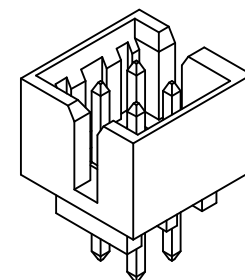

VIEW FOR HEADER  
WITH ONLY DUAL SLOTS

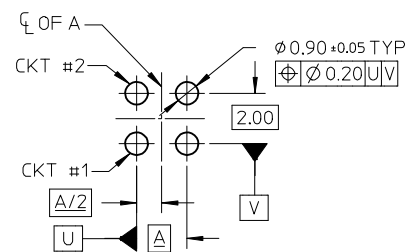

RECOMMENDED PCB LAYOUT

NOTES:

- MATERIALS:  
HOUSING: 30% GF, NYLON, UL94V-0, COLOR: BLACK  
PIN: 0.50MM SQ PHOSPHOR BRONZE
- FINISHES: REFER TO PLATING OPTIONS
- PRODUCT SPECIFICATION: PS-87831-027
- PACKAGING SPECIFICATION:  
TUBE: PK-87831-001, TAPE AND REEL: PK-87831-300
- MATES WITH: A. MOLEX CRIMP RECEPTACLE HOUSING: 51110 SERIES AND CRIMP TERMINAL: 50394 SERIES  
B. MOLEX 2MM MILLIGRID DUAL ROW IDT: 87568 SERIES  
C. MOLEX 2MM MILLIGRID DUAL ROW RECEPTACLE: 79107 (GOLD PLATED), 78787 (TIN PLATED)

RELEASED EC NO: S2015-1188 DRWING: GMENARLY CHK'D: CGOH APPR: KHL IM 2015/04/15 2015/06/29 2015/06/29	QUALITY SYMBOLS $F_A=0$ $F_G=0$ $F_P=0$	GENERAL TOLERANCES (UNLESS SPECIFIED)		DIMENSION STYLE MM ONLY	SCALE NTS	DESIGN UNITS METRIC	THIRD ANGLE PROJECTION		
		4 PLACES ± --- ± --- 3 PLACES ± --- ± --- 2 PLACES ± 0.20 ± --- 1 PLACE ± --- ± --- 0 PLACE ± --- ± ---	mm INCH	DRAWN BY GMENARLY	DATE 2015/04/15	TITLE MILLIGRID 2MM PITCH, THROUGH HOLE VERTICAL SHROUDED HEADER			
		ANGULAR ± 3°		CHECKED BY	DATE	APPROVED BY KHL IM			
		DRAFT WHERE APPLICABLE MUST REMAIN WITHIN DIMENSIONS		SEE TABLE		MATERIAL NO.	DATE 2015/06/29	DOCUMENT NO. SD-87831-0001	
A	REV	SIZE A3		THIS DRAWING CONTAINS INFORMATION THAT IS PROPRIETARY TO MOLEX INCORPORATED AND SHOULD NOT BE USED WITHOUT WRITTEN PERMISSION				SHEET NO. 2 OF 13	

4 CIRCUITS

CKT SIZE	ASSY P/N WITHOUT CAP IN TUBE	ASSY P/N WITH CAP IN TUBE	ASSY P/N WITH CAP IN T&R	PLATING OPTIONS	FRICTION LOCKS		SIDE SLOTS		CENTER POLARIZATION	PEG	DIMENSION							
					DUAL	CENTER	DUAL	SINGLE			A	B	C	D	E	F	G	H
4	87831-0419	N.A	N.A	1	N.A	N.A	YES	N.A	N.A	N.A	2.00	4.85	6.65	5.00	N.A	N.A	2.50	3.60±0.20
	87831-0420	N.A	N.A	2														
	87831-0421	N.A	N.A	3														
	87831-0436	N.A	N.A	4														
	87831-0441	87831-0456	N.A	2	N.A	YES	YES	N.A	N.A	N.A						1.00	2.50	
	87831-0442	N.A	N.A	3														
	87831-5141	N.A	N.A	2	N.A	YES	YES	N.A	N.A	N.A						3.50		
	87831-5142	N.A	N.A	3														
	87831-6141	N.A	N.A	2	N.A	YES	YES	N.A	N.A	N.A						2.80		
	87831-6142	N.A	N.A	3														
87831-0443	N.A	N.A	2	N.A	YES	N.A	YES	N.A	N.A	2.50								
87831-0444	N.A	N.A	3															

PLATING OPTIONS:

- 1 - 0.05-0.13um/2-5uin GOLD IN CONTACT AREA AND 1.88um/75uin MIN. MATTE TIN IN SOLDER TAIL AREA OVER 1.27um/50uin MIN. NICKEL OVERALL.
- 2 - 0.38um/15uin GOLD IN CONTACT AREA AND 1.88um/75uin MIN. MATTE TIN IN SOLDER TAIL AREA OVER 1.27um/50uin MIN. NICKEL OVERALL.
- 3 - 0.76um/30uin GOLD IN CONTACT AREA AND 1.88um/75uin MIN. MATTE TIN IN SOLDER TAIL AREA OVER 1.27um/50uin MIN. NICKEL OVERALL.
- 4 - 2.50um/100uin MIN. MATTE TIN OVER 1.25um/50uin MIN. NICKEL OVERALL.

RELEASED EC NO: S2015-1188 DRW:GMENARLY 2015/04/15 CHKD:CGOH 2015/06/29 APPR:KHLIM 2015/06/29	DESCRIPTION REV A	QUALITY SYMBOLS	GENERAL TOLERANCES (UNLESS SPECIFIED)	DIMENSION STYLE	SCALE	DESIGN UNITS	THIRD ANGLE PROJECTION		
		$F_A=0$ $F_G=0$ $F_P=0$	mm    INCH 4 PLACES ± --- ± --- 3 PLACES ± --- ± --- 2 PLACES ± 0.20 ± --- 1 PLACE ± --- ± --- 0 PLACE ± --- ± ---	MM ONLY	NTS	METRIC	DRAWN BY: GMENARLY DATE: 2015/04/15 CHECKED BY: _____ DATE: _____ APPROVED BY: KHLIM DATE: 2015/06/29	TITLE: MILLIGRID 2MM PITCH, THROUGH HOLE VERTICAL SHROUDED HEADER	
		ANGULAR ± 3 ° DRAFT WHERE APPLICABLE MUST REMAIN WITHIN DIMENSIONS	SEE TABLE	MATERIAL NO. _____ DOCUMENT NO. SD-87831-0001 SHEET NO. 3 OF 13					
		THIS DRAWING CONTAINS INFORMATION THAT IS PROPRIETARY TO MOLEX INCORPORATED AND SHOULD NOT BE USED WITHOUT WRITTEN PERMISSION							

6 CIRCUITS

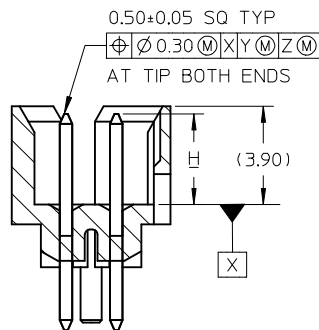
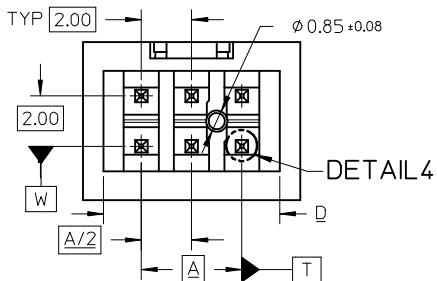
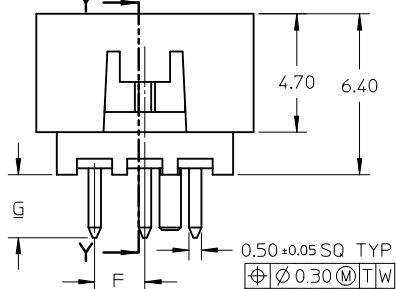
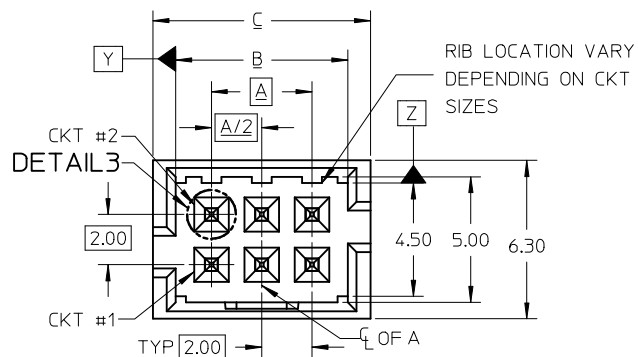

SECTION Y-Y

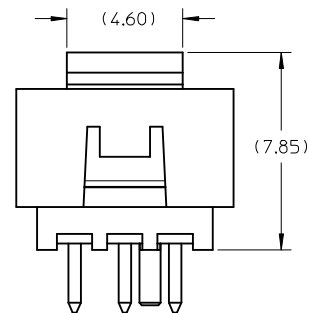

VIEW FOR HEADER WITH CAP

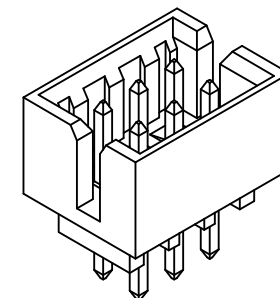

VIEW FOR HEADER WITH ONLY DUAL SLOTS

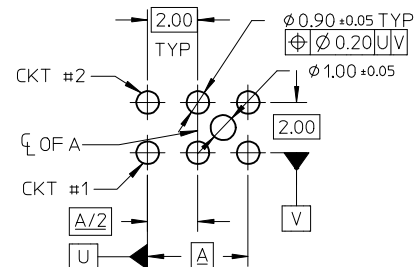

RECOMMENDED PCB LAYOUT

NOTES:

- MATERIALS:  
HOUSING: 30% GF, NYLON, UL94V-0, COLOR: BLACK  
PIN: 0.50MM SQ PHOSPHOR BRONZE
- FINISHES: REFER TO PLATING OPTIONS
- PRODUCT SPECIFICATION: PS-87831-027
- PACKAGING SPECIFICATION:  
TUBE: PK-87831-001, TAPE AND REEL: PK-87831-300
- MATES WITH: A. MOLEX CRIMP RECEPTACLE HOUSING: 51110 SERIES AND CRIMP TERMINAL: 50394 SERIES  
B. MOLEX 2MM MILLIGRID DUAL ROW IDT: 87568 SERIES  
C. MOLEX 2MM MILLIGRID DUAL ROW RECEPTACLE: 79107 (GOLD PLATED), 78787 (TIN PLATED)

RELEASED IEC NO: S2015-1188 DRAWN: GEMARLY 2015/04/15 CHKD: CGOH 2015/06/29 APPR: KHLIM 2015/06/29	DESCRIPTION	QUALITY SYMBOLS	GENERAL TOLERANCES (UNLESS SPECIFIED)		DIMENSION STYLE MM ONLY		SCALE NTS	DESIGN UNITS METRIC	THIRD ANGLE PROJECTION		
		▽ <sub>F</sub> =0	mm	INCH	DRAWN BY GMENARLY	DATE 2015/04/15	TITLE MILLIGRID 2MM PITCH, THROUGH HOLE VERTICAL SHROUDED HEADER				
		▽ <sub>E</sub> =0	4 PLACES ± --- ± ---	3 PLACES ± --- ± ---	2 PLACES ± 0.20 ± ---	CHECKED BY	DATE	DOCUMENT NO. SD-87831-0001			
		▽ <sub>F</sub> =0	1 PLACE ± --- ± ---	0 PLACE ± --- ± ---	APPROVED BY KHLIM	DATE 2015/06/29	SHEET NO. 4 OF 13				
A	REV	ANGULAR ± 3°	DRAFT WHERE APPLICABLE MUST REMAIN WITHIN DIMENSIONS		MATERIAL NO. SEE TABLE		THIS DRAWING CONTAINS INFORMATION THAT IS PROPRIETARY TO MOLEX INCORPORATED AND SHOULD NOT BE USED WITHOUT WRITTEN PERMISSION				

6 CIRCUITS

CKT SIZE	ASSY P/N WITHOUT CAP IN TUBE	ASSY P/N WITH CAP IN TUBE	ASSY P/N WITH CAP IN T&R	PLATING OPTIONS	FRICTION LOCKS		SIDE SLOTS		CENTER POLARIZATION	PEG	DIMENSION							
					DUAL	CENTER	DUAL	SINGLE			A	B	C	D	E	F	G	H
6	87831-0619	N.A	N.A	1	N.A	N.A	YES	N.A	N.A	N.A	4.00	6.85	8.65	7.00	N.A	N.A	2.50	3.60±0.20
	87831-0620	N.A	N.A	2														
	87831-0621	N.A	N.A	3														
	87831-0636	N.A	N.A	4														
	87831-0628	N.A	N.A	2	N.A	N.A	YES	N.A	N.A	YES						N.A	2.50	
	87831-0629	N.A	N.A	3														
	87831-0641	N.A	N.A	2	N.A	YES	YES	N.A	N.A	N.A						2.50		
	87831-0642	N.A	87831-5552	3														
	87831-5241	N.A	N.A	2														
	87831-5242	N.A	N.A	3	N.A	YES	YES	N.A	N.A	N.A						2.50		
	87831-6241	N.A	N.A	2														
	87831-6242	N.A	N.A	3														
	87831-6243	N.A	N.A	2														
	87831-0643	N.A	N.A	2	N.A	YES	N.A	YES	N.A	N.A						2.50		
	87831-0644	N.A	N.A	3														
	87831-0645	N.A	N.A	2														
87831-0646	N.A	N.A	3	N.A	YES	N.A	YES	N.A	YES	2.50								
87831-0632	N.A	N.A	2															
87831-5119	N.A	N.A	1	N.A	N.A	YES	N.A	YES	N.A	N.A	N.A	2.50	3.60±0.20					

PLATING OPTIONS:

- 1 - 0.05-0.13um/2-5uin GOLD IN CONTACT AREA AND 1.88um/75uin MIN. MATTE TIN IN SOLDER TAIL AREA OVER 1.27um/50uin MIN. NICKEL OVERALL.
- 2 - 0.38um/15uin GOLD IN CONTACT AREA AND 1.88um/75uin MIN. MATTE TIN IN SOLDER TAIL AREA OVER 1.27um/50uin MIN. NICKEL OVERALL.
- 3 - 0.76um/30uin GOLD IN CONTACT AREA AND 1.88um/75uin MIN. MATTE TIN IN SOLDER TAIL AREA OVER 1.27um/50uin MIN. NICKEL OVERALL.
- 4 - 2.50um/100uin MIN. MATTE TIN OVER 1.25um/50uin MIN. NICKEL OVERALL.

RELEASED EC NO: S2015-1188 DRW:GMENARLY 2015/04/15 CHKD:CGOH 2015/06/29 APPR:KHL IM 2015/06/29	DESCRIPTION QUALITY SYMBOLS $F_A=0$ $F_G=0$ $F_P=0$	GENERAL TOLERANCES (UNLESS SPECIFIED)		DIMENSION STYLE	SCALE	DESIGN UNITS	THIRD ANGLE PROJECTION	
				MM ONLY	NTS	METRIC		
				mm	INCH	DRAWN BY	DATE	TITLE
				4 PLACES ± --- ± ---	3 PLACES ± --- ± ---	GMENARLY	2015/04/15	MILLIGRID 2MM PITCH, THROUGH HOLE VERTICAL SHROUDED HEADER
		2 PLACES ± 0.20 ± ---	1 PLACE ± --- ± ---	CHECKED BY	DATE	molex		
		0 PLACE ± --- ± ---	ANGULAR ± 3 °	APPROVED BY	DATE			
		DRAFT WHERE APPLICABLE MUST REMAIN WITHIN DIMENSIONS		KHL IM	2015/06/29	DOCUMENT NO.	SHEET NO.	
				SEE TABLE		SD-87831-0001	5 OF 13	
				THIS DRAWING CONTAINS INFORMATION THAT IS PROPRIETARY TO MOLEX INCORPORATED AND SHOULD NOT BE USED WITHOUT WRITTEN PERMISSION				

8 TO 12 CIRCUITS

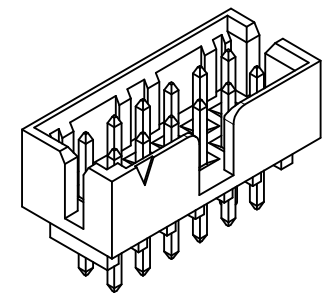
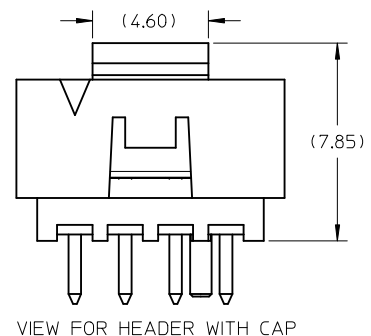
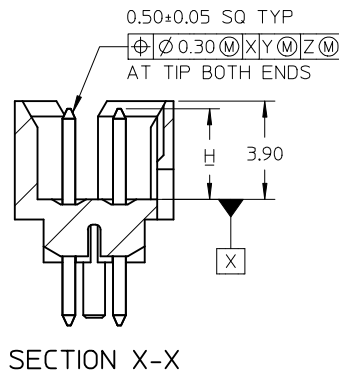
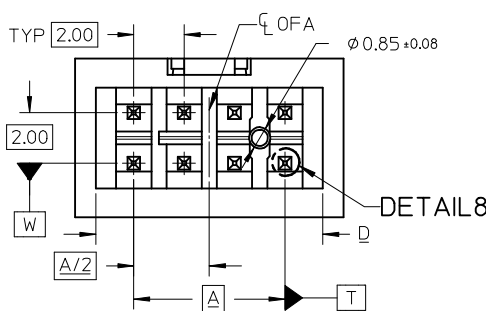
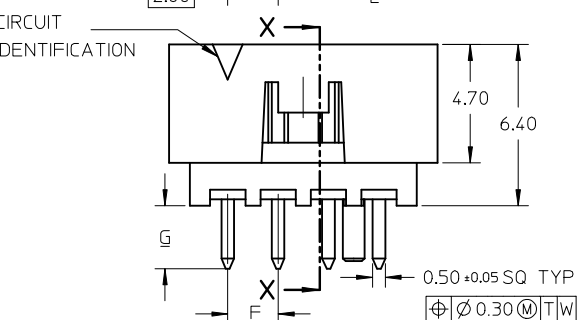

VIEW FOR HEADER WITH CENTER POLARIZATION AND DUAL SIDE SLOTS

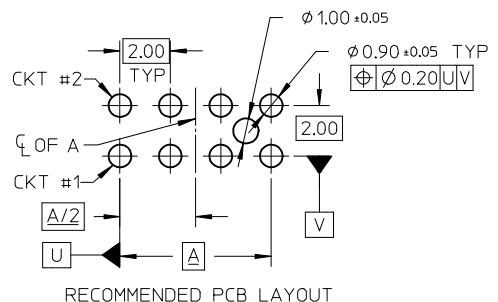

- NOTES:
- MATERIALS:  
HOUSING: 30% GF, NYLON, UL94V-0, COLOR: BLACK  
PIN: 0.50MM SQ PHOSPHOR BRONZE
  - FINISHES: REFER TO PLATING OPTIONS
  - PRODUCT SPECIFICATION: PS-87831-027
  - PACKAGING SPECIFICATION:  
TUBE: PK-87831-001, TAPE AND REEL: PK-87831-300
  - MATES WITH: A. MOLEX CRIMP RECEPTACLE HOUSING: 51110 SERIES AND CRIMP TERMINAL: 50394 SERIES  
B. MOLEX 2MM MILLIGRID DUAL ROW IDT: 87568 SERIES  
C. MOLEX 2MM MILLIGRID DUAL ROW RECEPTACLE: 79107 (GOLD PLATED), 78787 (TIN PLATED)

RELEASED EC NO: S2015-1188 DRWN:GMENARLY 2015/04/15 CHKD:CGOH 2015/06/29 APPR:KHLIM 2015/06/29	DESCRIPTION QUALITY SYMBOLS $\nabla_A=0$ $\nabla_E=0$ $\nabla_F=0$	GENERAL TOLERANCES (UNLESS SPECIFIED)		DIMENSION STYLE MM ONLY		SCALE NTS	DESIGN UNITS METRIC	THIRD ANGLE PROJECTION		
		mm	INCH	DRAWN BY GMENARLY	DATE 2015/04/15	TITLE MILLIGRID 2MM PITCH, THROUGH HOLE VERTICAL SHROUDED HEADER				
		4 PLACES ± --- ± ---	3 PLACES ± --- ± ---	CHECKED BY	DATE	APPROVED BY KHLIM 2015/06/29 MATERIAL NO. SEE TABLE DOCUMENT NO. SD-87831-0001 SHEET NO. 6 OF 13				
		2 PLACES ± 0.20 ± ---	1 PLACE ± --- ± ---	APPROVED BY	DATE					
ANGULAR ± 3°		DRAFT WHERE APPLICABLE MUST REMAIN WITHIN DIMENSIONS		SIZE A3		THIS DRAWING CONTAINS INFORMATION THAT IS PROPRIETARY TO MOLEX INCORPORATED AND SHOULD NOT BE USED WITHOUT WRITTEN PERMISSION				

8 CIRCUITS

F	CKT SIZE	ASSY P/N WITHOUT CAP IN TUBE	ASSY P/N WITH CAP IN TUBE	ASSY P/N WITH CAP IN T&R	PLATING OPTIONS	FRICTION LOCKS		SIDE SLOTS		CENTER POLARIZATION	PEG	DIMENSION														
						DUAL	CENTER	DUAL	SINGLE			A	B	C	D	E	F	G	H							
E	8	87831-0819	N.A	N.A	1	N.A	N.A	YES	N.A	YES	N.A	6.00	8.85	10.65	9.00	N.A	N.A	2.50	3.60±0.20							
	87831-0820	N.A	N.A	2																						
	87831-0821	N.A	N.A	3																						
	87831-0836	N.A	N.A	4	N.A	N.A	YES	N.A	YES	YES	YES						N.A	2.50								
	87831-0828	N.A	N.A	2																						
	87831-0829	N.A	N.A	3																						
	87831-0841	N.A	87831-5551	2	N.A	YES	YES	N.A	N.A	N.A	N.A						3.00	2.50								
	87831-0842	N.A	N.A	3																						
	87831-5441	N.A	N.A	2													N.A	YES		YES	N.A	N.A	N.A	N.A	3.50	
	87831-5442	N.A	N.A	3																						
	N.A	87831-5541	N.A	2	N.A	YES	YES	N.A	N.A	N.A	N.A						2.80									
	N.A	87831-5542	N.A	3																						
	D	8	87831-5741	N.A	N.A	2	N.A	YES	YES	N.A	N.A						N.A	6.00		8.85	10.65	9.00	N.A	3.00	4.70	3.60 <sup>+0.15</sup> <sub>-0.10</sub>
		87831-5742	N.A	N.A	3																					
		87831-0832	N.A	N.A	2	N.A	YES	YES	N.A	N.A	YES						YES							2.50		
87831-0843		N.A	N.A	2																						
87831-0844		N.A	N.A	3	N.A	YES	N.A	YES	N.A	N.A	2.50															
87831-0845		N.A	N.A	2																						
87831-0846		N.A	N.A	3	N.A	YES	N.A	YES	N.A	YES	YES	2.50														

PLATING OPTIONS:

- 1 - 0.05-0.13um/2-5uin GOLD IN CONTACT AREA AND 1.88um/75uin MIN. MATTE TIN IN SOLDER TAIL AREA OVER 1.27um/50uin MIN. NICKEL OVERALL.
- 2 - 0.38um/15uin GOLD IN CONTACT AREA AND 1.88um/75uin MIN. MATTE TIN IN SOLDER TAIL AREA OVER 1.27um/50uin MIN. NICKEL OVERALL.
- 3 - 0.76um/30uin GOLD IN CONTACT AREA AND 1.88um/75uin MIN. MATTE TIN IN SOLDER TAIL AREA OVER 1.27um/50uin MIN. NICKEL OVERALL.
- 4 - 2.50um/100uin MIN. MATTE TIN OVER 1.25um/50uin MIN. NICKEL OVERALL.

RELEASED EC NO: S2015-1188 DRAWN: GEMEARLY 2015/04/15 CH'KD: CGOH 2015/06/29 APPR: KHL IM 2015/06/29	QUALITY SYMBOLS	GENERAL TOLERANCES (UNLESS SPECIFIED)	DIMENSION STYLE	SCALE	DESIGN UNITS	THIRD ANGLE PROJECTION	
	$\nabla_A = 0$ $\nabla_C = 0$ $\nabla_P = 0$	mm    INCH 4 PLACES ± --- ± --- 3 PLACES ± --- ± --- 2 PLACES ± 0.20 ± --- 1 PLACE ± --- ± --- 0 PLACE ± --- ± ---	MM ONLY	NTS	METRIC		
		ANGULAR ± 3 °	DRAWN BY	DATE	TITLE		
		DRAFT WHERE APPLICABLE MUST REMAIN WITHIN DIMENSIONS	GEMEARLY	2015/04/15	MILLIGRID 2MM PITCH, THROUGH HOLE VERTICAL SHROUDED HEADER		
			KHL IM	2015/06/29			
		SEE TABLE		DOCUMENT NO.	SD-87831-0001	SHEET NO. 7 OF 13	
				THIS DRAWING CONTAINS INFORMATION THAT IS PROPRIETARY TO MOLEX INCORPORATED AND SHOULD NOT BE USED WITHOUT WRITTEN PERMISSION			

10 TO 12 CIRCUITS

CKT SIZE	ASSY P/N WITHOUT CAP IN TUBE	ASSY P/N WITH CAP IN TUBE	ASSY P/N WITH CAP IN T&R	PLATING OPTIONS	FRICTION LOCKS		SIDE SLOTS		CENTER POLARIZATION	PEG	DIMENSION														
					DUAL	CENTER	DUAL	SINGLE			A	B	C	D	E	F	G	H							
10	87831-1019	N.A	N.A	1	N.A	N.A	YES	N.A	YES	N.A	8.00	10.85	12.65	11.00	N.A	N.A	2.50	3.60±0.20							
	87831-1020	N.A	N.A	2																					
	87831-1021	N.A	N.A	3																					
	87831-1036	N.A	N.A	4																					
	87831-1010	N.A	N.A	2																					
	87831-1011	N.A	N.A	3																					
	87831-1028	N.A	N.A	2	N.A	N.A	YES	N.A	YES	YES						N.A	N.A	N.A	N.A	N.A	N.A	2.50	3.60±0.15 -0.10		
	87831-1029	N.A	N.A	3																					
	87831-1035	N.A	N.A	3																					
	87831-1041	N.A	N.A	2	N.A	YES	YES	N.A	N.A	N.A						N.A	N.A	N.A	N.A	N.A	N.A	N.A	2.50	3.60±0.15 -0.10	
	87831-1042	N.A	87831-5553	3																					
	87831-1032	N.A	N.A	2																					
87831-1043	N.A	N.A	2	N.A	YES	N.A	YES	N.A	N.A	N.A	N.A	N.A	N.A	N.A	N.A	N.A	2.50	3.60±0.15 -0.10							
87831-1044	N.A	N.A	3																						
87831-1045	N.A	N.A	2																						
87831-1046	N.A	N.A	3	N.A	YES	N.A	YES	N.A	YES	N.A	N.A	N.A	N.A	N.A	N.A	N.A	2.50	3.60±0.15 -0.10							
87831-1219	N.A	N.A	1																						
87831-1220	N.A	N.A	2																						
12	87831-1221	N.A	N.A	3	N.A	N.A	YES	N.A	YES	N.A	10.00	12.85	14.65	13.00	N.A	N.A	2.50	3.60±0.20							
	87831-1236	N.A	N.A	4																					
	87831-1228	N.A	N.A	2																					
	87831-1229	N.A	N.A	3																					
	87831-1241	N.A	N.A	2	N.A	YES	YES	N.A	N.A	N.A							N.A		N.A	N.A	N.A	N.A	N.A	2.50	3.60±0.15 -0.10
	87831-1242	N.A	N.A	3																					
	87831-1255	87831-1256	N.A	2																					
	87831-1232	N.A	N.A	2	N.A	YES	YES	N.A	N.A	N.A						N.A	N.A	N.A	N.A	N.A	N.A	N.A	2.50	3.60±0.15 -0.10	
	87831-1243	N.A	N.A	2																					
	87831-1244	N.A	N.A	3																					
	87831-1245	N.A	N.A	2	N.A	YES	N.A	YES	N.A	YES						N.A	N.A	N.A	N.A	N.A	N.A	N.A	2.50	3.60±0.15 -0.10	
	87831-1246	N.A	N.A	3																					

**PLATING OPTIONS:**  
 1 - 0.05-0.13um/2-5uin GOLD IN CONTACT AREA AND 1.88um/75uin MIN. MATTE TIN IN SOLDER TAIL AREA OVER 1.27um/50uin MIN. NICKEL OVERALL.  
 2 - 0.38um/15uin GOLD IN CONTACT AREA AND 1.88um/75uin MIN. MATTE TIN IN SOLDER TAIL AREA OVER 1.27um/50uin MIN. NICKEL OVERALL.  
 3 - 0.76um/30uin GOLD IN CONTACT AREA AND 1.88um/75uin MIN. MATTE TIN IN SOLDER TAIL AREA OVER 1.27um/50uin MIN. NICKEL OVERALL.  
 4 - 2.50um/100uin MIN. MATTE TIN OVER 1.25um/50uin MIN. NICKEL OVERALL.

<b>RELEASED</b> EC NO: S2015-1188 DRW:GMENARLY 2015/04/15 CHKD:CGOH 2015/06/29 APPR:KHLIM 2015/06/29	QUALITY SYMBOLS $F_A=0$ $F_G=0$ $F_P=0$	GENERAL TOLERANCES (UNLESS SPECIFIED)		DIMENSION STYLE <b>MM ONLY</b>		SCALE NTS	DESIGN UNITS METRIC	THIRD ANGLE PROJECTION		
		4 PLACES ± --- ± ---	mm	INCH	DRAWN BY GMENARLY	DATE 2015/04/15	TITLE MILLIGRID 2MM PITCH, THROUGH HOLE VERTICAL SHROUDED HEADER			
		3 PLACES ± --- ± ---			CHECKED BY	DATE	APPROVED BY KHLIM			
		2 PLACES ± 0.20 ± ---			APPROVED BY KHLIM	DATE 2015/06/29	MATERIAL NO. <b>SEE TABLE</b>			
		1 PLACE ± --- ± ---				DOCUMENT NO. SD-87831-0001		SHEET NO. 8 OF 13		
		0 PLACE ± --- ± ---				THIS DRAWING CONTAINS INFORMATION THAT IS PROPRIETARY TO MOLEX INCORPORATED AND SHOULD NOT BE USED WITHOUT WRITTEN PERMISSION				
		ANGULAR ± 3 °								
		DRAFT WHERE APPLICABLE MUST REMAIN WITHIN DIMENSIONS								



14 TO 50 CIRCUITS



SECTION W-W



DETAIL5



DETAIL6



RECOMMENDED PCB LAYOUT

NOTES:

- MATERIALS:  
HOUSING: 30% GF, NYLON, UL94V-0, COLOR: BLACK  
PIN: 0.50MM SQ PHOSPHOR BRONZE
- FINISHES: REFER TO PLATING OPTIONS
- PRODUCT SPECIFICATION: PS-87831-027
- PACKAGING SPECIFICATION:  
TUBE: PK-87831-001, TAPE AND REEL: PK-87831-300
- MATES WITH: A. MOLEX CRIMP RECEPTACLE HOUSING: 51110 SERIES AND CRIMP TERMINAL: 50394 SERIES  
B. MOLEX 2MM MILLIGRID DUAL ROW IDT: 87568 SERIES  
C. MOLEX 2MM MILLIGRID DUAL ROW RECEPTACLE: 79107 (GOLD PLATED), 78787 (TIN PLATED)

RELEASED EC NO: S2015-1188 DRWN:GMENARLY CHKD:CGOH APPR:KHL IM	2015/04/15 2015/06/29 2015/06/29	DESCRIPTION QUALITY SYMBOLS $F_a=0$ $F_b=0$ $F_p=0$	GENERAL TOLERANCES (UNLESS SPECIFIED)		DIMENSION STYLE	SCALE	DESIGN UNITS	THIRD ANGLE PROJECTION				
					MM ONLY	NTS	METRIC					
			mm	INCH	DRAWN BY	DATE	TITLE					
					GMENARLY	2015/04/15	MILLIGRID 2MM PITCH, THROUGH HOLE VERTICAL SHROUDED HEADER					
		4 PLACES	± ---	± ---	CHECKED BY	DATE	molex SD-87831-0001					
		3 PLACES	± ---	± ---	APPROVED BY						DATE	DOCUMENT NO.
		2 PLACES	± 0.20	± ---	KHL IM		2015/06/29	SD-87831-0001	9 OF 13			
		1 PLACE	± ---	± ---	MATERIAL NO.							
		0 PLACE	± ---	± ---	SEE TABLE							
		ANGULAR ± 3°			THIS DRAWING CONTAINS INFORMATION THAT IS PROPRIETARY TO MOLEX INCORPORATED AND SHOULD NOT BE USED WITHOUT WRITTEN PERMISSION							
		DRAFT WHERE APPLICABLE MUST REMAIN WITHIN DIMENSIONS			SIZE A3							

14 TO 20 CIRCUITS

F	CKT SIZE	ASSY P/N WITHOUT CAP IN TUBE	ASSY P/N WITH CAP IN TUBE	ASSY P/N WITH CAP IN T&R	PLATING OPTIONS	FRICTION LOCKS		SIDE SLOTS		CENTER POLARIZATION	PEG	DIMENSION							
						DUAL	CENTER	DUAL	SINGLE			A	B	C	D	E	F	G	H
E	14	87831-1419	N.A	N.A	1	YES	N.A	YES	N.A	YES	N.A	12.00	14.85	16.65	15.00	8.00	N.A	2.50	3.60±0.20
		87831-1420	N.A	87831-5554	2														
		87831-1421	N.A	N.A	3														
		87831-1436	N.A	N.A	4														
		87831-1428	N.A	N.A	2														
		87831-1429	N.A	N.A	3														
		87831-1435	N.A	N.A	3														
D	16	87831-1410	N.A	N.A	2	YES	N.A	YES	N.A	YES	N.A	14.00	16.85	18.65	17.00	10.00	N.A	2.50	3.60±0.20
		87831-1411	N.A	N.A	3														
		87831-1619	N.A	N.A	1														
		87831-1620	N.A	N.A	2														
		87831-1621	N.A	N.A	3														
		87831-1636	N.A	N.A	4														
		87831-1628	N.A	N.A	2														
C	18	87831-1629	N.A	N.A	3	YES	N.A	YES	N.A	YES	N.A	16.00	18.85	20.65	19.00	12.00	N.A	2.50	3.60±0.20
		87831-1819	N.A	N.A	1														
		87831-1820	N.A	N.A	2														
		87831-1821	N.A	N.A	3														
		87831-1836	N.A	N.A	4														
		87831-1828	N.A	N.A	2														
A	20	87831-1829	N.A	N.A	3	YES	N.A	YES	N.A	YES	N.A	18.00	20.85	22.65	21.00	14.00	N.A	2.50	3.60±0.20
		87831-2019	N.A	N.A	1														
		87831-2020	N.A	N.A	2														
		87831-2021	N.A	N.A	3														
		87831-2036	N.A	N.A	4														
		87831-2028	N.A	N.A	2														
		87831-2029	N.A	N.A	3														
		87831-2035	N.A	N.A	3														
87831-2010	N.A	N.A	2																
87831-2011	N.A	N.A	3																

**PLATING OPTIONS:**

- 0.05-0.13um/2-5uin GOLD IN CONTACT AREA AND 1.88um/75uin MIN. MATTE TIN IN SOLDER TAIL AREA OVER 1.27um/50uin MIN. NICKEL OVERALL.
- 0.38um/15uin GOLD IN CONTACT AREA AND 1.88um/75uin MIN. MATTE TIN IN SOLDER TAIL AREA OVER 1.27um/50uin MIN. NICKEL OVERALL.
- 0.76um/30uin GOLD IN CONTACT AREA AND 1.88um/75uin MIN. MATTE TIN IN SOLDER TAIL AREA OVER 1.27um/50uin MIN. NICKEL OVERALL.
- 2.50um/100uin MIN. MATTE TIN OVER 1.25um/50uin MIN. NICKEL OVERALL.

RELEASED EC NO: S2015-1188 DRW:GMENARLY 2015/04/15 CHKD:CGOH 2015/06/29 APPR:KHLIM 2015/06/29	DESCRIPTION REV	QUALITY SYMBOLS	GENERAL TOLERANCES (UNLESS SPECIFIED)		DIMENSION STYLE		SCALE	DESIGN UNITS	THIRD ANGLE PROJECTION			
		$F_A=0$ $F_G=0$ $F_P=0$	mm	INCH	MM ONLY	NTS	METRIC	DRAWN BY: GMENARLY DATE: 2015/04/15 CHECKED BY: _____ DATE: _____		TITLE MILLIGRID 2MM PITCH, THROUGH HOLE VERTICAL SHROUDED HEADER 		
		4 PLACES ± --- ± --- 3 PLACES ± --- ± --- 2 PLACES ± 0.20 ± --- 1 PLACE ± --- ± --- 0 PLACE ± --- ± ---	ANGULAR ± 3 °		DRAWN BY: KHLIM DATE: 2015/06/29		APPROVED BY: _____ DATE: 2015/06/29		MATERIAL NO. SEE TABLE			
		DRAFT WHERE APPLICABLE MUST REMAIN WITHIN DIMENSIONS		SIZE A3	THIS DRAWING CONTAINS INFORMATION THAT IS PROPRIETARY TO MOLEX INCORPORATED AND SHOULD NOT BE USED WITHOUT WRITTEN PERMISSION							

22 TO 30 CIRCUITS

F	CKT SIZE	ASSY P/N WITHOUT CAP IN TUBE	ASSY P/N WITH CAP IN TUBE	ASSY P/N WITH CAP IN T&R	PLATING OPTIONS	FRICTION LOCKS		SIDE SLOTS		CENTER POLARIZATION	PEG	DIMENSION													
						DUAL	CENTER	DUAL	SINGLE			A	B	C	D	E	F	G	H						
22	87831-2219	N.A	N.A	1	YES	N.A	YES	N.A	YES	N.A	20.00	22.85	24.65	23.00	16.00	N.A	2.50	3.60±0.20							
	87831-2220	N.A	N.A	2																					
	87831-2221	N.A	N.A	3																					
	87831-2236	N.A	N.A	4																					
	87831-2228	N.A	N.A	2																					
87831-2229	N.A	N.A	3	YES	N.A	YES	N.A	YES	YES	2.50															
24	87831-2419	N.A	N.A	1	YES	N.A	YES	N.A	YES	N.A	22.00	24.85	26.65	25.00	18.00	N.A	2.50	3.60±0.20							
	87831-2420	N.A	N.A	2																					
	87831-2421	N.A	N.A	3																					
	87831-2436	N.A	N.A	4																					
	87831-2428	N.A	N.A	2																					
	87831-2429	N.A	N.A	3																					
	87831-2435	N.A	N.A	3															YES	N.A	YES	N.A	YES	YES	3.50
87831-2410	N.A	N.A	2	YES	N.A	YES	N.A	YES	N.A	3.50															
26	87831-2619	N.A	N.A	1	YES	N.A	YES	N.A	YES	N.A	24.00	26.85	28.65	27.00	20.00	N.A	2.50	3.60±0.20							
	87831-2620	N.A	N.A	2																					
	87831-2621	N.A	N.A	3																					
	87831-2636	N.A	N.A	4																					
	87831-2628	N.A	N.A	2																					
	87831-2629	N.A	N.A	3																					
	87831-2610	N.A	N.A	2															YES	N.A	YES	N.A	YES	N.A	3.50
28	87831-2819	N.A	N.A	1	YES	N.A	YES	N.A	YES	N.A	26.00	28.85	30.65	29.00	22.00	N.A	2.50	3.60±0.20							
	87831-2820	N.A	N.A	2																					
	87831-2821	N.A	N.A	3																					
	87831-2836	N.A	N.A	4																					
	87831-2828	N.A	N.A	2																					
	87831-2829	N.A	N.A	3															YES	N.A	YES	N.A	YES	YES	2.50
30	87831-3019	N.A	N.A	1	YES	N.A	YES	N.A	YES	N.A	28.00	30.85	32.65	31.00	24.00	N.A	2.50	3.60±0.20							
	87831-3020	N.A	N.A	2																					
	87831-3021	N.A	N.A	3																					
	87831-3036	N.A	N.A	4																					
	87831-3028	N.A	N.A	2																					
	87831-3029	N.A	N.A	3															YES	N.A	YES	N.A	YES	YES	2.50
	87831-3035	N.A	N.A	3															YES	N.A	YES	N.A	YES	YES	3.50
87831-3010	87831-3030	87831-3050	2	YES	N.A	YES	N.A	YES	N.A	3.50															

**PLATING OPTIONS:**  
 1 - 0.05-0.13um/2-5uin GOLD IN CONTACT AREA AND 1.88um/75uin MIN. MATTE TIN IN SOLDER TAIL AREA OVER 1.27um/50uin MIN. NICKEL OVERALL.  
 2 - 0.38um/15uin GOLD IN CONTACT AREA AND 1.88um/75uin MIN. MATTE TIN IN SOLDER TAIL AREA OVER 1.27um/50uin MIN. NICKEL OVERALL.  
 3 - 0.76um/30uin GOLD IN CONTACT AREA AND 1.88um/75uin MIN. MATTE TIN IN SOLDER TAIL AREA OVER 1.27um/50uin MIN. NICKEL OVERALL.  
 4 - 2.50um/100uin MIN. MATTE TIN OVER 1.25um/50uin MIN. NICKEL OVERALL.

RELEASED  
 IEC NO: S2015-1188  
 DRW:GMENARLY 2015/04/15  
 CH:KD:G0H 2015/06/29  
 APPR:KHL IM 2015/06/29

QUALITY SYMBOLS  
 $\nabla_A = 0$   
 $\nabla_B = 0$   
 $\nabla_C = 0$

GENERAL TOLERANCES (UNLESS SPECIFIED)  
 mm INCH  
 4 PLACES ± --- ± ---  
 3 PLACES ± --- ± ---  
 2 PLACES ± 0.20 ± ---  
 1 PLACE ± --- ± ---  
 0 PLACE ± --- ± ---  
 ANGULAR ± 3 °  
 DRAFT WHERE APPLICABLE MUST REMAIN WITHIN DIMENSIONS

DIMENSION STYLE: MM ONLY  
 SCALE: NTS  
 DESIGN UNITS: METRIC  
 THIRD ANGLE PROJECTION  
 DRAWN BY: GMENARLY DATE: 2015/04/15  
 CHECKED BY: DATE: DATE: DATE:  
 APPROVED BY: KHL IM DATE: 2015/06/29  
 MATERIAL NO.: SEE TABLE  
 DOCUMENT NO.: SD-87831-0001  
 SHEET NO.: 11 OF 13  
 THIS DRAWING CONTAINS INFORMATION THAT IS PROPRIETARY TO MOLEX INCORPORATED AND SHOULD NOT BE USED WITHOUT WRITTEN PERMISSION

32 TO 40 CIRCUITS

F	CKT SIZE	ASSY P/N WITHOUT CAP IN TUBE	ASSY P/N WITH CAP IN TUBE	ASSY P/N WITH CAP IN T&R	PLATING OPTIONS	FRICTION LOCKS		SIDE SLOTS		CENTER POLARIZATION	PEG	DIMENSION						
						DUAL	CENTER	DUAL	SINGLE			A	B	C	D	E	F	G
32	87831-3219	N.A	N.A	1	YES	N.A	YES	N.A	YES	N.A	30.00	32.85	34.65	33.00	26.00	N.A	2.50	3.60±0.20
	87831-3220	N.A	N.A	2														
	87831-3221	N.A	N.A	3														
	87831-3236	N.A	N.A	4														
	87831-3228	N.A	N.A	2														
87831-3229	N.A	N.A	3	YES	N.A	YES	N.A	YES	YES	2.50								
34	87831-3419	N.A	N.A	1	YES	N.A	YES	N.A	YES	N.A	32.00	34.85	36.65	35.00	28.00	N.A	2.50	3.60±0.20
	87831-3420	N.A	N.A	2														
	87831-3421	N.A	N.A	3														
	87831-3436	N.A	N.A	4														
	87831-3428	N.A	N.A	2														
	87831-3429	N.A	N.A	3														
87831-3435	N.A	N.A	3	YES	N.A	YES	N.A	YES	YES	3.50								
36	87831-3619	N.A	N.A	1	YES	N.A	YES	N.A	YES	N.A	34.00	36.85	38.65	37.00	30.00	N.A	2.50	3.60±0.20
	87831-3620	N.A	N.A	2														
	87831-3621	N.A	N.A	3														
	87831-3636	N.A	N.A	4														
	87831-3628	N.A	N.A	2														
	87831-3629	N.A	N.A	3														
38	87831-3819	N.A	N.A	1	YES	N.A	YES	N.A	YES	N.A	36.00	38.85	40.65	39.00	32.00	N.A	2.50	3.60±0.20
	87831-3820	N.A	N.A	2														
	87831-3821	N.A	N.A	3														
	87831-3836	N.A	N.A	4														
	87831-3828	N.A	N.A	2														
	87831-3829	N.A	N.A	3														
40	87831-4019	N.A	N.A	1	YES	N.A	YES	N.A	YES	N.A	38.00	40.85	42.65	41.00	34.00	N.A	2.50	3.60±0.20
	87831-4020	N.A	N.A	2														
	87831-4021	N.A	N.A	3														
	87831-4036	N.A	N.A	4														
	87831-4028	N.A	N.A	2														
	87831-4029	N.A	N.A	3														
	87831-4010	N.A	N.A	2														

PLATING OPTIONS:

- 1 - 0.05-0.13um/2-5uin GOLD IN CONTACT AREA AND 1.88um/75uin MIN. MATTE TIN IN SOLDER TAIL AREA OVER 1.27um/50uin MIN. NICKEL OVERALL.
- 2 - 0.38um/15uin GOLD IN CONTACT AREA AND 1.88um/75uin MIN. MATTE TIN IN SOLDER TAIL AREA OVER 1.27um/50uin MIN. NICKEL OVERALL.
- 3 - 0.76um/30uin GOLD IN CONTACT AREA AND 1.88um/75uin MIN. MATTE TIN IN SOLDER TAIL AREA OVER 1.27um/50uin MIN. NICKEL OVERALL.
- 4 - 2.50um/100uin MIN. MATTE TIN OVER 1.25um/50uin MIN. NICKEL OVERALL.

RELEASED EC NO: S2015-1188 DRWING:GMENARLY 2015/04/15 CHKD:CGOH 2015/06/29 APPR:KHLIM 2015/06/29	DESCRIPTION	QUALITY SYMBOLS	GENERAL TOLERANCES (UNLESS SPECIFIED)	DIMENSION STYLE	SCALE	DESIGN UNITS	THIRD ANGLE PROJECTION	
		$F_A=0$ $F_G=0$ $F_P=0$	mm    INCH 4 PLACES ± --- ± --- 3 PLACES ± --- ± --- 2 PLACES ± 0.20 ± --- 1 PLACE ± --- ± --- 0 PLACE ± --- ± ---	MM ONLY	NTS	METRIC	DRAWN BY: GMENARLY    DATE: 2015/04/15 CHECKED BY:    DATE:	MILLIGRID 2MM PITCH, THROUGH HOLE VERTICAL SHROUDED HEADER  DOCUMENT NO. SD-87831-0001    SHEET NO. 12 OF 13
		ANGULAR ± 3 ° DRAFT WHERE APPLICABLE MUST REMAIN WITHIN DIMENSIONS	APPROVED BY: KHLIM    DATE: 2015/06/29 MATERIAL NO.    SEE TABLE					
		THIS DRAWING CONTAINS INFORMATION THAT IS PROPRIETARY TO MOLEX INCORPORATED AND SHOULD NOT BE USED WITHOUT WRITTEN PERMISSION						

42 TO 50 CIRCUITS

CKT SIZE	ASSY P/N WITHOUT CAP IN TUBE	ASSY P/N WITH CAP IN TUBE	ASSY P/N WITH CAP IN T&R	PLATING OPTIONS	FRICTION LOCKS		SIDE SLOTS		CENTER POLARIZATION	PEG	DIMENSION							
					DUAL	CENTER	DUAL	SINGLE			A	B	C	D	E	F	G	H
42	87831-4219	N.A	N.A	1	YES	N.A	YES	N.A	YES	N.A	40.00	42.85	44.65	43.00	36.00	N.A	2.50	3.60±0.20
	87831-4220	N.A	N.A	2														
	87831-4221	N.A	N.A	3														
	87831-4236	N.A	N.A	4														
	87831-4228	N.A	N.A	2	YES	N.A	YES	N.A	YES	YES							2.50	
87831-4229	N.A	N.A	3															
44	87831-4419	N.A	N.A	1	YES	N.A	YES	N.A	YES	N.A	42.00	44.85	46.65	45.00	38.00	N.A	2.50	3.60±0.20
	87831-4420	N.A	N.A	2														
	87831-4421	N.A	N.A	3														
	87831-4436	N.A	N.A	4														
	87831-4428	N.A	N.A	2	YES	N.A	YES	N.A	YES	YES							2.50	
	87831-4429	N.A	N.A	3	YES	N.A	YES	N.A	YES	YES							3.50	
46	87831-4619	N.A	N.A	1	YES	N.A	YES	N.A	YES	N.A	44.00	46.85	48.65	47.00	40.00	N.A	2.50	3.60±0.20
	87831-4620	N.A	N.A	2														
	87831-4621	N.A	N.A	3														
	87831-4636	N.A	N.A	4														
	87831-4628	N.A	N.A	2	YES	N.A	YES	N.A	YES	YES							2.50	
	87831-4629	N.A	N.A	3														
48	87831-4819	N.A	N.A	1	YES	N.A	YES	N.A	YES	N.A	46.00	48.85	50.65	49.00	42.00	N.A	2.50	3.60±0.20
	87831-4820	N.A	N.A	2														
	87831-4821	N.A	N.A	3														
	87831-4836	N.A	N.A	4														
	87831-4828	N.A	N.A	2	YES	N.A	YES	N.A	YES	YES							2.50	
	87831-4829	N.A	N.A	3														
50	87831-5019	N.A	N.A	1	YES	N.A	YES	N.A	YES	N.A	48.00	50.85	52.65	51.00	44.00	N.A	2.50	3.60±0.20
	87831-5020	N.A	N.A	2														
	87831-5021	N.A	N.A	3														
	87831-5036	N.A	N.A	4														
	87831-5028	N.A	N.A	2	YES	N.A	YES	N.A	YES	YES							2.50	
	87831-5029	N.A	N.A	3	YES	N.A	YES	N.A	YES	YES							3.50	
87831-5035	N.A	N.A	3															

PLATING OPTIONS:

- 1 - 0.05-0.13um/2-5uin GOLD IN CONTACT AREA AND 1.88um/75uin MIN. MATTE TIN IN SOLDER TAIL AREA OVER 1.27um/50uin MIN. NICKEL OVERALL.
- 2 - 0.38um/15uin GOLD IN CONTACT AREA AND 1.88um/75uin MIN. MATTE TIN IN SOLDER TAIL AREA OVER 1.27um/50uin MIN. NICKEL OVERALL.
- 3 - 0.76um/30uin GOLD IN CONTACT AREA AND 1.88um/75uin MIN. MATTE TIN IN SOLDER TAIL AREA OVER 1.27um/50uin MIN. NICKEL OVERALL.
- 4 - 2.50um/100uin MIN. MATTE TIN OVER 1.25um/50uin MIN. NICKEL OVERALL.

RELEASED IEC NO: S2015-1188 DRWNG:GMENARLY 2015/04/15 CHK'D:CGOH 2015/06/29 APPR:KHLIM 2015/06/29	QUALITY SYMBOLS $\nabla_F = 0$ $\nabla_E = 0$ $\nabla_D = 0$	GENERAL TOLERANCES (UNLESS SPECIFIED)		DIMENSION STYLE MM ONLY		SCALE NTS	DESIGN UNITS METRIC	THIRD ANGLE PROJECTION		
			mm	INCH	DRAWN BY GMENARLY	DATE 2015/04/15	TITLE MILLIGRID 2MM PITCH, THROUGH HOLE VERTICAL SHROUDED HEADER <b>molex</b> DOCUMENT NO. SD-87831-0001 SHEET NO. 13 OF 13			
		4 PLACES	± ---	± ---	CHECKED BY	DATE				
		3 PLACES	± ---	± ---	APPROVED BY KHLIM		DATE 2015/06/29	THIS DRAWING CONTAINS INFORMATION THAT IS PROPRIETARY TO MOLEX INCORPORATED AND SHOULD NOT BE USED WITHOUT WRITTEN PERMISSION		
2 PLACES	± 0.20	± ---	MATERIAL NO. SEE TABLE		SIZE A3					
1 PLACE	± ---	± ---	DRAFT WHERE APPLICABLE MUST REMAIN WITHIN DIMENSIONS							
0 PLACE	± ---	± ---								

## Данный компонент на территории Российской Федерации

### Вы можете приобрести в компании MosChip.

Для оперативного оформления запроса Вам необходимо перейти по данной ссылке:

<http://moschip.ru/get-element>

Вы можете разместить у нас заказ для любого Вашего проекта, будь то серийное производство или разработка единичного прибора.

В нашем ассортименте представлены ведущие мировые производители активных и пассивных электронных компонентов.

Нашей специализацией является поставка электронной компонентной базы двойного назначения, продукции таких производителей как XILINX, Intel (ex.ALTERA), Vicor, Microchip, Texas Instruments, Analog Devices, Mini-Circuits, Amphenol, Glenair.

Сотрудничество с глобальными дистрибьюторами электронных компонентов, предоставляет возможность заказывать и получать с международных складов практически любой перечень компонентов в оптимальные для Вас сроки.

На всех этапах разработки и производства наши партнеры могут получить квалифицированную поддержку опытных инженеров.

Система менеджмента качества компании отвечает требованиям в соответствии с ГОСТ Р ИСО 9001, ГОСТ РВ 0015-002 и ЭС РД 009

### Офис по работе с юридическими лицами:

105318, г.Москва, ул.Щербаковская д.3, офис 1107, 1118, ДЦ «Щербаковский»

Телефон: +7 495 668-12-70 (многоканальный)

Факс: +7 495 668-12-70 (доб.304)

E-mail: [info@moschip.ru](mailto:info@moschip.ru)

Skype отдела продаж:

moschip.ru

moschip.ru\_4

moschip.ru\_6

moschip.ru\_9