

3000 series

Premium Hall effect joysticks

Distinctive features and specifications



- Class leading installed depth <20 mm
- Hall effect sensing
- 1, 2 or 3 axis
- 5V or 3.3V operation
- EMC shielded
- Analog or PWM outputs
- Next generation metal mechanisms
- Dual outputs available

ELECTRICAL

- Gain (Output Voltage Span): $\pm 10\% \times V$ to $\pm 50\% \times V$
- Output at Center: $V/2 \pm (5\% \times \text{Gain})$
- Power Supply: 5V $\pm 0.5V$ Transient free
(Configs 1, 3, 4 & 5) or 3.3V $\pm 0.1V$ (Config 2)
- Center Tap Impedance: 1K1
- Center Detect Output: Pulled high within joystick
via 2K2 to +V, and smoothed to 0V with 100nF
- Sensor Type: Hall effect
- Current Consumption:
5V <13mA (Two axis) <20mA (Three axis)
3.3V <24mA (Two axis) <40mA (Three axis)
- Loads: Minimum 10K, preferred 100K+

ENVIRONMENTAL

- Operating Temperature: -25°C to 70°C (-13°F to 158°F)
- Storage Temperature: -40°C to 70°C (-40°F to 158°F)
- Seal Above Panel: IP65 – Neoprene boot fitted as standard
- EMC Emission: Complies with EN 61000-6-3:2001,
CISPR 22:2005, Class B 30MHz–11GHz
- Life Cycles: 10,000,000 cycles
(5,000,000 for 3 axis joysticks)
- ESD: Complies with EN61000-4-2 (extended)
 $\pm 8KV$ (20 contacts) & $\pm 15KV$ (20 air discharges)
- EMC Immunity: 100V/m, 80MHz-2.7GHz,
1KHz 80% sine wave modulation,
EN 61000-4-3 (extended)
- Vibration: 100Hz – 200Hz @ 0.13g /Hz, total 3.6gRMS
(1 Hour in each of the three mutually perpendicular axis)

MECHANICAL

- Materials Employed: Shaft - Stainless Steel
Boot - Neoprene
Others - Brass, Nylon, ABS
- Weight: 100g (0.20lb) nominal
- Breakout Force: 1.3N (2.86lbf)
- Mechanical Angle of Movement:
36° for X and Y axis (subject to limiter)
50° for Z axis (subject to handle)
- Max Load to Mechanism: 400N (881.85lbf)

NOTES:

1. All values are nominal.
2. All specifications shown are based on a standard configuration and are provided for guidance only.
3. Please refer to APEM for assistance on how to achieve the best performance from your chosen configuration.
4. Current consumption will be greater for dual output configurations.

3000 series

Premium Hall effect joysticks

Overview

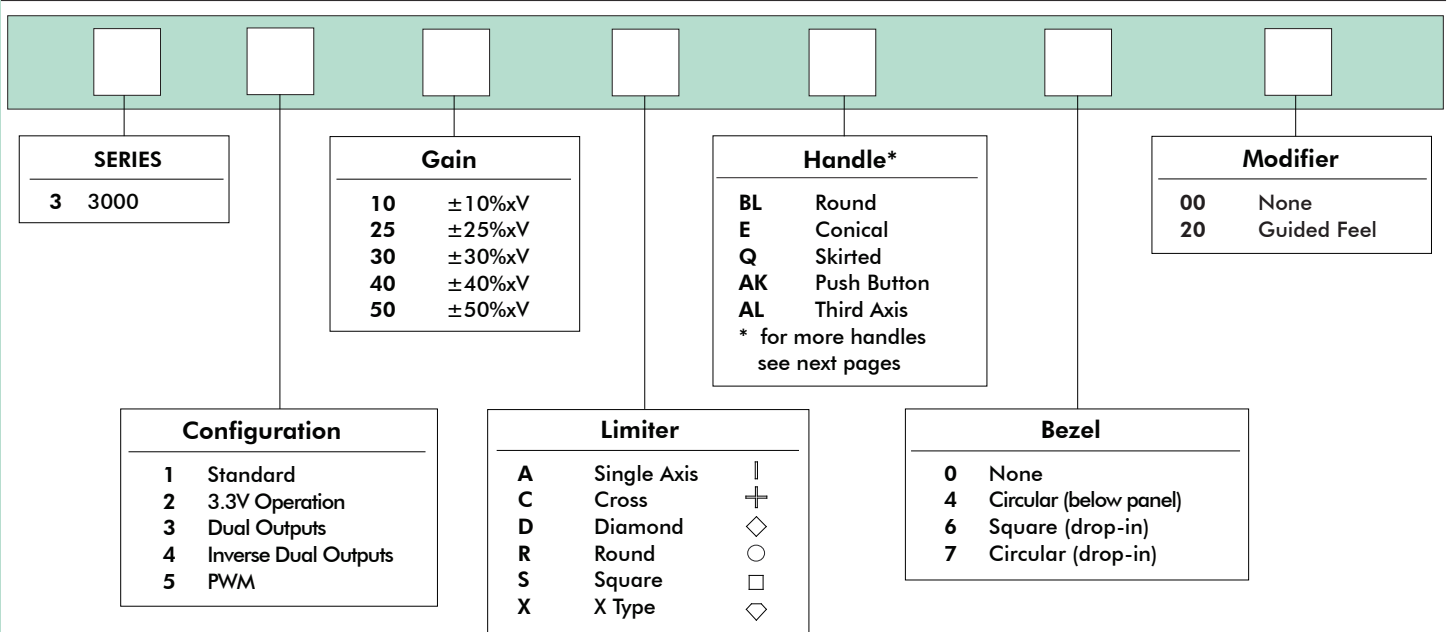

STANDARD OPTION AVAILABILITY

The following table shows which permutations of options are possible.

CONFIGURATION	CT	CD	AXES			SUPPLY		GAIN					LIMITERS						ALL HANDLES	ALL BEZELS				
			X	Y	Z	3.3V	5V	10	25	30	40	50	A	C	D	R	S	X						
1	✓	✓	✓	✓	✓	✗	✓	✓	✓	✓	✓	✓	✓	✓	✓	✓	✓	✓	✓	✓	✓	✓	✓	✓
2	✗	✗	✓	✓	✓	✓	✗	✗	✗	✗	✗	✗	✓	✓	✓	✓	✓	✓	✓	✓	✓	✓	✓	✓
3	✗	✗	✓	✓	✓	✗	✓	✓	✓	✓	✓	✓	✓	✓	✓	✓	✓	✓	✓	✓	✓	✓	✓	✓
4	✗	✗	✓	✓	✓	✗	✓	✓	✓	✓	✓	✓	✓	✓	✓	✓	✓	✓	✓	✓	✓	✓	✓	✓
5	✗	✗	✓	✓	✓	✗	✓	✗	✗	✗	✗	✗	✗	✓	✓	✓	✓	✓	✓	✓	✓	✓	✓	✓



NOTES:

- Dimensions are in mm/(inch).
 - The dimensions shown are for generic 3000 series with E type handle. For specific dimensions of this or any other configuration please refer to APEM.
- * 3000 series has slotted mounting holes - allows compatibility with mounting pitches of 32.25mm to 35.80mm.

Note: The company reserves the right to change specifications without notice.

3000 series

Premium Hall effect joysticks

Overview

DROP IN MOUNTING - PANEL CUT-OUT & MOUNTING INSTALLATION



MOUNTING CUT-OUT



The joystick is dropped into the panel cut-out. For panel thickness of <3mm, M3 x 16 countersunk machine screws are recommended.
Please note: Image (left) shows a square bezel, a circular bezel is also available for this option.

SUB MOUNTING OPTION A - PANEL CUT-OUT & MOUNTING INSTALLATION

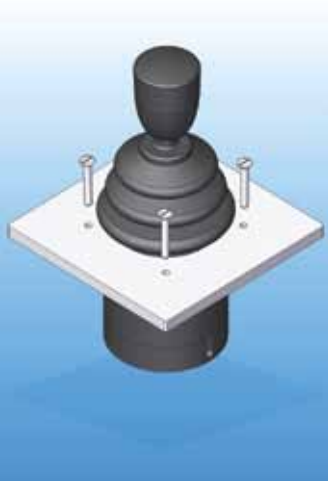

MOUNTING CUT-OUT



When mounted this way the panel acts as the bezel and no separate bezel is needed. M3 machine screws are recommended.

SUB MOUNTING OPTION B - PANEL CUT-OUT AND MOUNTING INSTALLATION



MOUNTING CUT-OUT

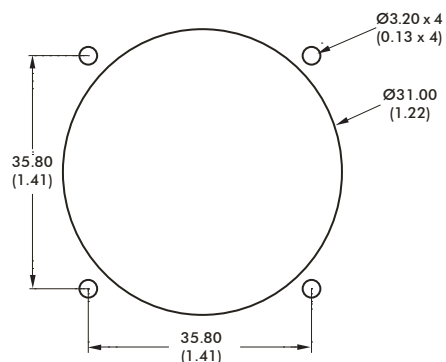

The joystick is mounted beneath the panel and the base of the boot must be brought through the panel cut-out and held in place with the circular bezel.
For panel thickness of <3mm, M3 x 16 countersunk machine screws are recommended.

- NOTES:
- * 3000 series has slotted mounting holes - allows compatibility with mounting pitches of 32.25mm to 35.80mm.
 - 1. Dimensions are in mm/(inch).
 - 2. The dimensions shown are for generic 3000 series with E type handle. For specific dimensions of this or any other configuration please refer to APEM.
 - 3. When sub panel mounting, great care should be taken not to damage the boot, or any of the mechanism under the boot. All panel cut-outs should be free from sharp edges and debris that may damage the boot.

Note: The company reserves the right to change specifications without notice.

3000 series

Premium Hall effect joysticks

Overview

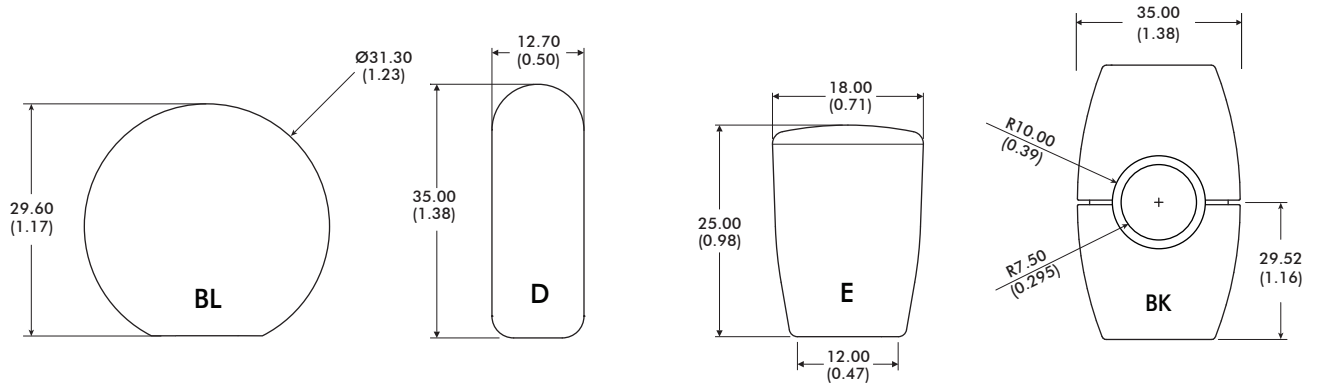

MATERIAL	Nylon	Aluminum	Nylon	ABS
FINISH	Sparkled Matt	Anodized	Sparkled Matt	Sparkled Matt
STANDARD COLOR	Black	Black	Black	Black
OTHER COLORS	Not Available	Not Available	Upon Request	Upon Request
NOTES:				Uses APEM IA Switch



MATERIAL	ABS	Aluminum	Aluminum	Nylon
FINISH	Sparkled Matt	Anodized	Anodized	Sparkled Matt
STANDARD COLOR	Black	Black	Black	Black
OTHER COLORS	Upon Request	Not Available	Not Available	Upon Request
NOTES:	Uses APEM IS Switch	Uses APEM IS Switch Z axis functionality	Uses APEM IS Switch Z axis functionality	



MATERIAL	Aluminum	ABS	Aluminum	Aluminum
FINISH	Anodized	Sparkled Matt	Anodized with Diamond Knurl	Anodized with Diamond Knurl
STANDARD COLOR	Black	Black	Black	Black
OTHER COLORS	Not available	Upon Request	Not Available	Not Available
NOTES:		Uses APEM IS Switch	Z axis functionality	

Note: The company reserves the right to change specifications without notice.

3000 series

Premium Hall effect joysticks

Overview



MATERIAL	Aluminum	Aluminum	Nylon	Aluminum
FINISH	Anodized	Anodized	Sparked Matt	Anodized
STANDARD COLOR	Black	Black	Black	Black
OTHER COLORS	Not Available	Not Available	Upon Request	Not Available
NOTES:	Uses APEM IS Switch	Uses APEM IA Switch	Z axis functionality	Uses APEM IA Switch



MATERIAL	Santoprene over Nylon	Aluminum	Aluminum	Black Mineral Filled Nylon
FINISH	Soft Touch	Anodized	Anodized	Light Sparked Finish
STANDARD COLOR	Black	Black	Black	Black
OTHER COLORS	Upon Request	Not Available	Not Available	Not Available
NOTES:	Z axis functionality		Uses APEM IA Switch	Mec sealed Switch on Deadman



MATERIAL	Nylon	Nylon	Aluminum	Stainless Steel
FINISH	Sparked Matt	Sparked Matt	Anodized	Natural
STANDARD COLOR	Black	Black	Black	Stainless Steel
OTHER COLORS	Upon Request	Not Available	Not Available	Not Available
NOTES:		Uses APEM IL switch	Z axis functionality	Uses APEM IS switch

NOTES:

1. Dimensions are in mm/(inch).
2. Unless otherwise specified, all joysticks are supplied with black switches in the handles.

Note: The company reserves the right to change specifications without notice.

3000 series

Premium Hall effect joysticks

Overview

VOLTAGE OUTPUT OPTIONS

SINGLE OUTPUT - CONFIGURATION 1

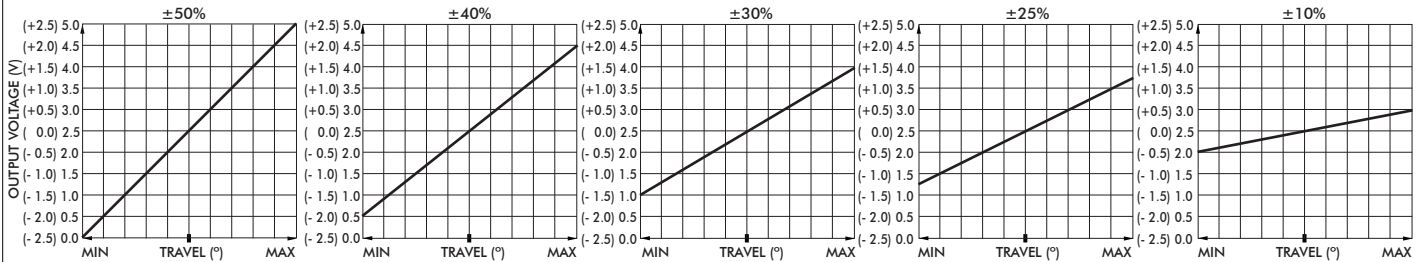

DUAL OUTPUT - CONFIGURATION 3

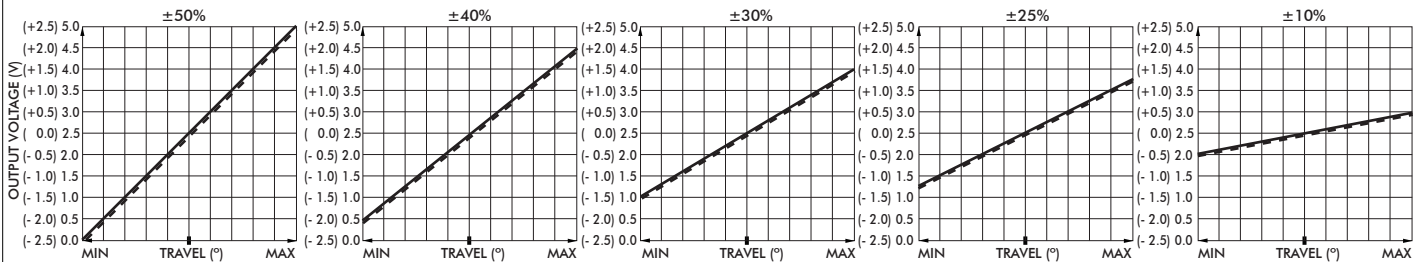

DUAL OUTPUT - CONFIGURATION 4

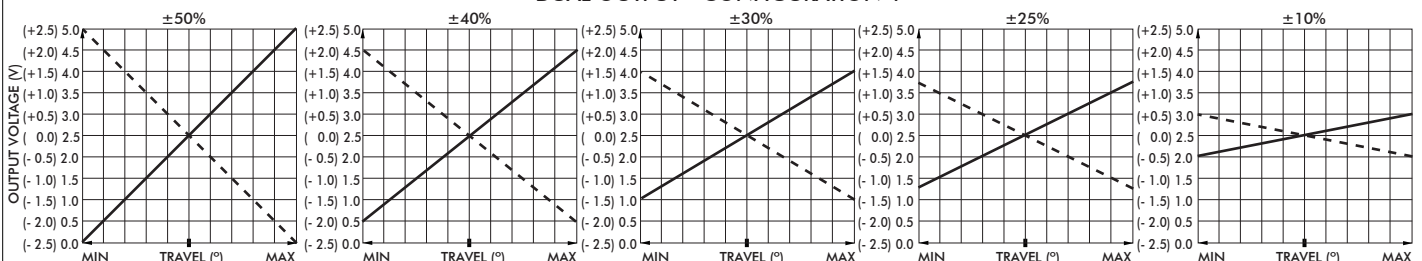

POWER SUPPLY

The 3000 series is designed to be powered by a regulated $5V \pm 0.5V$ power supply. The outputs are ratiometric, making a stable, noise free, power supply essential. The 3.3V version of the 3000 series requires a power supply accurate to $\pm 0.1V$. The outputs are not ratiometric, the voltage gain is set to 50% as standard, giving an output range from 0 to 3.3V regardless of supply voltage. The power supply to the joystick should be carefully regulated to be within tolerance. Should the power supply change outside of the specified tolerances, permanent damage may occur.

MAGNETIC IMMUNITY AND SYSTEM DESIGN

The 3000 series incorporates internal magnetic screening to minimise the effect of external magnetic fields. Mounting or operating the joystick close to strong magnetic fields is not recommended. System designers should follow best practice when incorporating the 3000 series joystick into their products. Care should be taken to decouple the power supply properly and to employ adequate EMC shielding.

MOUNTING

When mounting the joystick, care should be taken to site it in a position that does not make it vulnerable to damage when in use. If the joystick is intended for use in a handheld enclosure then care must be taken to protect the joystick from damage caused by dropping. Basic precautions such as mounting it at the lightest end of the enclosure so it doesn't hit the ground first or by protecting it with a guard should always be implemented for long term reliability. The body of the joystick, on the underside of the panel, must not be subject to water spray, excessive humidity or dust. Some handles may be larger than some panel cut-outs. This may restrict the choice of mounting and bezel options. Please refer to APEM for assistance.

3000 series

Premium Hall effect joysticks

Overview

CENTER DETECT (CD)

Where selected, (configuration 1 types) the output on this additional cable will be 0V while the joystick is inactive. Should either the X or Y outputs change outside of the center tolerance, indicating that the joystick has been operated, the center detect signal will switch to 5V. Within the joystick this output is pulled high by a 2K2 resistor and is decoupled by a 100nF capacitor to 0V. This output is designed for use in applications requiring an enable/disable signal that is separate from the main wipers. It is not recommended for use as a safety feature or a method of "person-present" detection.

CENTER TAP REFERENCE (CT)

Where selected, (configurations 1, 3 and 4) the joystick also outputs a center reference voltage that is set at 50% ($\pm 1\%$) of the supply voltage. This output can be used to check the integrity of the power supply applied to the joystick. A reading on this output, outside of the specified tolerance suggests a problem with the power supply to the joystick. The other purpose of this output is to act as a reference equal to the voltage output when the lever is at center. Measuring the voltage outputs relative to CT rather than 0V eliminates inaccuracies created by variation in supply voltage.

GAIN OPTIONS

The voltage output on the wipers, at full scale deflection is determined by the gain. The gain is expressed as a percentage of the voltage supplied. Therefore (assuming a 5V supply) a joystick specified with $\pm 25\%$ gain would yield 1.25V at South, 2.5V at center and 3.75V at North. A range of gain options are available as standard for configurations 1, 3 and 4. All joysticks are supplied pre-set and no further calibration is needed throughout the lifetime of operation.

OUTPUT IMPEDANCE

The voltage outputs at center and at each end of travel are specified across an infinite load, with no current flowing. The output impedance specified in the electrical specification should be taken into account when designing a system. Load resistance of less than 10K Ohms is not recommended.

MECHANISM

The omni-directional mechanism utilizes an extremely robust ball-socket pivot. This construction yields an end product that is extremely resistant to vertical impact. Furthermore it constantly withstands high pull, push, rotational or horizontal forces that the product may be subject to, during life.

SPRINGING

All 3000 series are offered sprung to center. The standard spring force requires 1.3N (nominally) to off-center the joystick. The 3000 series may be specified with a lighter spring (1N), or a stronger spring (1.6N).

GUIDED FEEL

The 3000 series may also be specified with guided feel. A joystick with guided feel moves more readily towards the poles (N, S, E and W) and whilst it can still move away from the poles, the force required to do so is greater. Unless specified otherwise, joysticks are supplied as standard without guiding. This standard configuration allows the user to move the joystick anywhere within the limiter with the same force and without any bias.

CONNECTIONS

The joystick is fitted, as standard, with 150mm long BS6360 rated cables and an industry standard 2.5mm pitch connector(s). Further non-standard connectors and cable options are available upon request.

CONFIGURATIONS 1 & 2

Joysticks are supplied with a seven way connector as standard. If the joystick is specified with a pushbutton handle, the connector will be nine way.

- PIN 1:** 0V (Black)
- PIN 2:** Center Tap Reference (Green)
- PIN 3:** Z Axis Output (Purple) - Where Specified
- PIN 4:** Y Axis Output (Yellow)
- PIN 5:** X Axis Output (Blue) - Where Specified
- PIN 6:** +V (Red)
- PIN 7:** Center Detect (Orange)
- PIN 8:** Pushbutton (Orange)
- PIN 9:** Pushbutton (Orange)

CONFIGURATIONS 3 & 4

Joysticks are supplied with two completely independent cable assemblies for a truly dual system.

- PIN 1:** 0V (Black)
- PIN 2:** Center Tap Reference (Green)
- PIN 3:** No connection
- PIN 4:** Y Axis Output (Yellow)
- PIN 5:** X Axis Output (Blue) - Where Specified
- PIN 6:** +V (Red)
- PIN 7:** No connection

For details on configuration 5 pinout, please refer to Customer Support.

Данный компонент на территории Российской Федерации

Вы можете приобрести в компании MosChip.

Для оперативного оформления запроса Вам необходимо перейти по данной ссылке:

<http://moschip.ru/get-element>

Вы можете разместить у нас заказ для любого Вашего проекта, будь то серийное производство или разработка единичного прибора.

В нашем ассортименте представлены ведущие мировые производители активных и пассивных электронных компонентов.

Нашей специализацией является поставка электронной компонентной базы двойного назначения, продукции таких производителей как XILINX, Intel (ex.ALTERA), Vicor, Microchip, Texas Instruments, Analog Devices, Mini-Circuits, Amphenol, Glenair.

Сотрудничество с глобальными дистрибьюторами электронных компонентов, предоставляет возможность заказывать и получать с международных складов практически любой перечень компонентов в оптимальные для Вас сроки.

На всех этапах разработки и производства наши партнеры могут получить квалифицированную поддержку опытных инженеров.

Система менеджмента качества компании отвечает требованиям в соответствии с ГОСТ Р ИСО 9001, ГОСТ РВ 0015-002 и ЭС РД 009

Офис по работе с юридическими лицами:

105318, г.Москва, ул.Щербаковская д.3, офис 1107, 1118, ДЦ «Щербаковский»

Телефон: +7 495 668-12-70 (многоканальный)

Факс: +7 495 668-12-70 (доб.304)

E-mail: info@moschip.ru

Skype отдела продаж:

moschip.ru

moschip.ru_4

moschip.ru_6

moschip.ru_9