

## Low-power, 2.5 MHz, RR IO, 36 V BiCMOS operational amplifier

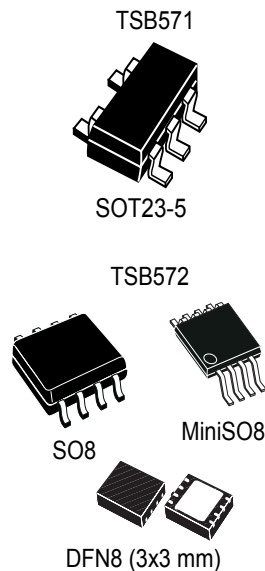

### Features

- Low-power consumption: 380  $\mu$ A typ.
- Wide supply voltage: 4 V - 36 V
- Rail-to-rail input and output
- Gain bandwidth product: 2.5 MHz
- Low input bias current: 30 nA max.
- No phase reversal
- High tolerance to ESD: 4 kV HBM
- Extended temperature range: -40 °C to 125 °C
- Automotive grade
- Small SMD packages
- 40 V BiCMOS technology
- Enhanced stability vs. capacitive load

### Applications

- Active filtering
- Audio systems
- Automotive
- Power supplies
- Industrial
- Low/high side current sensing

### Description

The **TSB571** and **TSB572** operational amplifiers offer an extended voltage operating range from 4 V to 36 V and rail-to-rail input/output.

The **TSB571** and **TSB572** give a very good speed/power consumption ratio with a 2.5 MHz gain bandwidth product and a consumption of 380  $\mu$ A typically only at 36 V supply voltage.

Stability and robustness of these devices make them an ideal solution for a wide voltage range of applications.

#### Maturity status link

[TSB751, TSB752](#)

#### Related products

[TSB611](#)

For below 100  $\mu$ A solution



**Table 2. Pin description (miniSO8/SO8/DFN8)**

Pin	Pin name	Description
1	OUT1	Output channel 1
2	IN1-	Inverting input channel 1
3	IN1+	Non-inverting input channel 1
4	V <sub>CC-</sub>	Negative supply voltage
5	IN2+	Non-inverting input channel 2
6	IN2-	Inverting input channel 2
7	OUT2	Output channel 2
8	V <sub>CC+</sub>	Positive supply voltage

## 2 Absolute maximum ratings and operating conditions

**Table 3. Absolute maximum ratings**

Symbol	Parameter	Value	Unit	
$V_{CC}$	Supply voltage <sup>(1)</sup>	40	V	
$V_{id}$	Differential input voltage <sup>(2)</sup>	±1		
$V_{in}$	Input voltage <sup>(3)</sup>	$(V_{CC^-}) - 0.2$ to $(V_{CC^+}) + 0.2$		
$I_{in}$	Input current <sup>(4)</sup>	10	mA	
$T_{stg}$	Storage temperature	-65 to 150	°C	
$T_j$	Maximum junction temperature	150		
$R_{thja}$	Thermal resistance junction to ambient <sup>(5) (6)</sup>	SOT23-5	250	°C/W
		MiniSO8	190	
		DFN8 3x3	40	
		SO-8	125	
ESD	Human body model (HBM) <sup>(7)</sup>	4	kV	
	Machine model (MM) <sup>(8)</sup>	100	V	
	CDM: charged device model <sup>(9)</sup>	1.5	kV	
	Latch-up immunity	100	mA	

1. All voltage values, except the differential voltage are with respect to network ground terminal.
2. Differential voltages are the non-inverting input terminal with respect to the inverting input terminal.
3.  $V_{CC}-V_{in}$  must not exceed 40 V,  $V_{in}$  must not exceed 40 V.
4. Input current must be limited by a resistor in-series with the inputs.
5.  $R_{th}$  are typical values.
6. Short-circuits can cause excessive heating and destructive dissipation.
7. According to JEDEC standard JESD22-A114F.
8. According to JEDEC standard JESD22-A115A.
9. According to ANSI/ESD STM5.3.1.

**Table 4. Operating conditions**

Symbol	Parameter	Value	Unit
$V_{CC}$	Supply voltage	4 to 36	V
$V_{icm}$	Common mode input voltage range	$(V_{CC^-}) - 0.1$ to $(V_{CC^+}) + 0.1$	
$T_{oper}$	Operating free-air temperature range	-40 to 125	°C

### 3 Electrical characteristics

**Table 5. Electrical characteristics at  $V_{CC} = 4\text{ V}$ ,  $V_{icm} = V_{CC}/2$ ,  $T_{amb} = 25\text{ °C}$ , and  $R_L$  connected to  $V_{CC}/2$  (unless otherwise specified)**

Symbol	Parameter	Conditions	Min.	Typ.	Max.	Unit
DC performance						
$V_{io}$	Input offset voltage		-1.5		1.5	mV
		$-40\text{ °C} < T < 125\text{ °C}$	-2.1		2.1	
$\Delta V_{io}/\Delta T$	Input offset voltage drift	$-40\text{ °C} < T < 125\text{ °C}$		1.5	6	$\mu\text{V}/\text{°C}$
$I_{io}$	Input offset current			2	15	nA
		$-40\text{ °C} < T < 125\text{ °C}$			35	
$I_{ib}$	Input bias current			8	30	nA
		$-40\text{ °C} < T < 125\text{ °C}$			70	
$C_{IN}$	Input capacitor			2		pF
$R_{IN}$	Input impedance			1		T $\Omega$
CMR	Common mode rejection ratio 20 log ( $\Delta V_{icm}/\Delta V_{io}$ )	$V_{icm} = (V_{CC-})$ to $(V_{CC+}) - 1.5\text{ V}$ , $V_{out} = V_{CC}/2$	90	114		dB
		$-40\text{ °C} < T < 125\text{ °C}$	80			
		$V_{icm} = (V_{CC-})$ to $(V_{CC+})$ , $V_{out} = V_{CC}/2$	75	97		
		$-40\text{ °C} < T < 125\text{ °C}$	70			
$A_{vd}$	Large signal voltage gain	$R_L = 10\text{ k}\Omega$ , $V_{out} = 0.5$ to $3.5\text{ V}$	90	100		
		$-40\text{ °C} < T < 125\text{ °C}$	85			
$V_{OH}$	High level output voltage (drop voltage from $(V_{CC+})$ )	$R_L = 10\text{ k}\Omega$		19	60	mV
		$-40\text{ °C} < T < 125\text{ °C}$			80	
$V_{OL}$	Low level output voltage	$R_L = 10\text{ k}\Omega$		12	50	mV
		$-40\text{ °C} < T < 125\text{ °C}$			70	
$I_{out}$	$I_{sink}$	$V_{out} = V_{CC}$	20	38		mA
		$-40\text{ °C} < T < 125\text{ °C}$	5			
	$I_{source}$	$V_{out} = 0\text{ V}$	10	32		
		$-40\text{ °C} < T < 125\text{ °C}$	5			
$I_{CC}$	Supply current (per channel)	No load, $V_{out} = V_{CC}/2$		340	430	$\mu\text{A}$
		$-40\text{ °C} < T < 125\text{ °C}$			500	
AC performance						
GBP	Gain bandwidth product	$R_L = 10\text{ k}\Omega$ , $C_L = 100\text{ pF}$	1.5	2.2		MHz
		$-40\text{ °C} < T < 125\text{ °C}$	1.2			
$\phi_m$	Phase margin	$R_L = 10\text{ k}\Omega$ , $C_L = 100\text{ pF}$		45		degrees
$G_m$	Gain margin	$R_L = 10\text{ k}\Omega$ , $C_L = 100\text{ pF}$		5		dB

Symbol	Parameter	Conditions	Min.	Typ.	Max.	Unit
SR	Negative slew rate	$V_{in} = 3.5$ to $0.5$ V, $A_v = 1$ , 10 % to 90 %, $R_L = 10$ k $\Omega$ , $C_L = 100$ pF	0.50	0.78		V/ $\mu$ s
		$-40$ °C < T < 125 °C	0.37			
	Positive slew rate	$V_{in} = 0.5$ to $3.5$ V, $A_v = 1$ , 10 % to 90 %, $R_L = 10$ k $\Omega$ , $C_L = 100$ pF	0.50	0.89		
		$-40$ °C < T < 125 °C	0.37			
$e_n$	Equivalent input noise voltage	f = 1 kHz		20		nV/ $\sqrt$ Hz
		f = 0.1 Hz to 10 Hz		0.7		$\mu$ Vpp
THD+N	Total harmonic distortion + noise	f = 1 kHz, $V_{in} = 3.8$ V <sub>pp</sub> , $R_L = 10$ k $\Omega$ , $C_L = 100$ pF		0.001		%

**Table 6. Electrical characteristics at  $V_{CC} = 12$  V,  $V_{icm} = V_{CC}/2$ ,  $T_{amb} = 25$  °C, and  $R_L$  connected to  $V_{CC}/2$  (unless otherwise specified)**

Symbol	Parameter	Conditions	Min.	Typ.	Max.	Unit
DC performance						
$V_{io}$	Input offset voltage		-1.5		1.5	mV
		$-40$ °C < T < 125 °C	-2.1		2.1	
$\Delta V_{io}/\Delta T$	Input offset voltage drift	$-40$ °C < T < 125 °C		1.5	6	$\mu$ V/°C
$I_{io}$	Input offset current			2	15	nA
		$-40$ °C < T < 125 °C			35	
$I_{ib}$	Input bias current			8	30	
		$-40$ °C < T < 125 °C			70	
$C_{IN}$	Input capacitor			2		pF
$R_{IN}$	Input impedance			1		T $\Omega$
CMR	Common mode rejection ratio 20 log ( $\Delta V_{icm}/\Delta V_{io}$ )	$V_{icm} = (V_{CC-})$ to $(V_{CC+}) - 1.5$ V, $V_{out} = V_{CC}/2$	100	123		dB
		$-40$ °C < T < 125 °C	90			
		$V_{icm} = (V_{CC-})$ to $(V_{CC+})$ , $V_{out} = V_{CC}/2$	85	106		
		$-40$ °C < T < 125 °C	80			
SVR	Supply voltage rejection ratio 20 log ( $\Delta V_{CC}/\Delta V_{io}$ )	$V_{CC} = 4$ to 12 V	90	99		
		$-40$ °C < T < 125 °C	80			
$A_{vd}$	Large signal voltage gain	$R_L = 10$ k $\Omega$ , $V_{out} = 0.5$ to 11.5 V	95	106		
		$-40$ °C < T < 125 °C	90			
$V_{OH}$	High level output voltage (drop voltage from $V_{CC+}$ )	$R_L = 10$ k $\Omega$		38	100	mV
		$-40$ °C < T < 125 °C			150	
$V_{OL}$	Low level output voltage	$R_L = 10$ k $\Omega$		16	70	mV
		$-40$ °C < T < 125 °C			90	
$I_{out}$	$I_{sink}$	$V_{out} = V_{CC}$	20	42		mA
		$-40$ °C < T < 125 °C	8			
	$I_{source}$	$V_{out} = 0$ V	15	35		
		$-40$ °C < T < 125 °C	7			

Symbol	Parameter	Conditions	Min.	Typ.	Max.	Unit
I <sub>CC</sub>	Supply current (per channel)	No load, V <sub>out</sub> = V <sub>CC</sub> /2		360	450	μA
		-40 °C < T < 125 °C			530	
AC performance						
GBP	Gain bandwidth product	R <sub>L</sub> = 10 kΩ, C <sub>L</sub> = 100 pF	1.6	2.4		MHz
		-40 °C < T < 125 °C	1.3			
φ <sub>m</sub>	Phase margin	R <sub>L</sub> = 10 kΩ, C <sub>L</sub> = 100 pF		50		degrees
G <sub>m</sub>	Gain margin	R <sub>L</sub> = 10 kΩ, C <sub>L</sub> = 100 pF		6		dB
SR	Negative slew rate	V <sub>in</sub> = 10.5 to 1.5 V, A <sub>v</sub> = 1, 10 % to 90 %, R <sub>L</sub> = 10 kΩ, C <sub>L</sub> = 100 pF	0.53	0.82		V/μs
		-40 °C < T < 125 °C	0.40			
	Positive slew rate	V <sub>in</sub> = 1.5 to 10.5 V, A <sub>v</sub> = 1, 10 % to 90 %, R <sub>L</sub> = 10 kΩ, C <sub>L</sub> = 100 pF	0.55	0.92		
		-40 °C < T < 125 °C	0.40			
e <sub>n</sub>	Equivalent input noise voltage	f = 1 kHz		20		nV/√Hz
		f = 0.1 Hz to 10 Hz		0.7		μVpp
THD+N	Total harmonic distortion + noise	f = 1 kHz, V <sub>in</sub> = 7 V <sub>pp</sub> , R <sub>L</sub> = 10 kΩ, C <sub>L</sub> = 100 pF		0.0005		%

**Table 7. Electrical characteristics at V<sub>CC</sub> = 36 V, V<sub>icm</sub> = V<sub>CC</sub>/2, T<sub>amb</sub> = 25 °C, and R<sub>L</sub> connected to V<sub>CC</sub>/2 (unless otherwise specified)**

Symbol	Parameter	Conditions	Min.	Typ.	Max.	Unit
DC performance						
V <sub>io</sub>	Input offset voltage		-1.5		1.5	mV
		-40 °C < T < 125 °C	-2.1		2.1	
ΔV <sub>io</sub> /ΔT	Input offset voltage drift	-40 °C < T < 125 °C		1.5	6	μV/°C
ΔV <sub>io</sub>	Long-term input offset voltage drift <sup>(1)</sup>	T = 25 °C		1.5		μV/√month
I <sub>io</sub>	Input offset current			2	15	nA
		-40 °C < T < 125 °C			35	
I <sub>ib</sub>	Input bias current			8	30	nA
		-40 °C < T < 125 °C			70	
C <sub>IN</sub>	Input capacitor			2		pF
R <sub>IN</sub>	Input impedance			1		TΩ
CMR	Common mode rejection ratio 20 log (ΔV <sub>icm</sub> /ΔV <sub>io</sub> )	V <sub>icm</sub> = (V <sub>CC-</sub> ) to (V <sub>CC+</sub> ) - 1.5 V, V <sub>out</sub> = V <sub>CC</sub> /2	105	129		dB
		-40 °C < T < 125 °C	95			
		V <sub>icm</sub> = (V <sub>CC-</sub> ) to (V <sub>CC+</sub> ), V <sub>out</sub> = V <sub>CC</sub> /2	95	115		
		-40 °C < T < 125 °C	90			
SVR	Supply voltage rejection ratio 20 log (ΔV <sub>CC</sub> /ΔV <sub>io</sub> )	V <sub>CC</sub> = 4 to 36 V	90	104		dB
		-40 °C < T < 125 °C	85			
A <sub>vd</sub>	Large signal voltage gain	R <sub>L</sub> = 10 kΩ, V <sub>out</sub> = 0.5 to 35.5 V	95	114		dB
		-40 °C < T < 125 °C	90			

Symbol	Parameter	Conditions	Min.	Typ.	Max.	Unit
$V_{OH}$	High level output voltage (drop voltage from $V_{CC+}$ )	$R_L = 10\text{ k}\Omega$		78	150	mV
		$-40\text{ }^\circ\text{C} < T < 125\text{ }^\circ\text{C}$			200	
$V_{OL}$	Low level output voltage	$R_L = 10\text{ k}\Omega$		30	90	mV
		$-40\text{ }^\circ\text{C} < T < 125\text{ }^\circ\text{C}$			120	
$I_{out}$	$I_{sink}$	$V_{out} = V_{CC}$	25	65		mA
		$-40\text{ }^\circ\text{C} < T < 125\text{ }^\circ\text{C}$	10			
	$I_{source}$	$V_{out} = 0\text{ V}$	20	50		
		$-40\text{ }^\circ\text{C} < T < 125\text{ }^\circ\text{C}$	10			
$I_{CC}$	Supply current (per channel)	No load, $V_{out} = V_{CC}/2$		380	470	$\mu\text{A}$
		$-40\text{ }^\circ\text{C} < T < 125\text{ }^\circ\text{C}$			550	
AC performance						
GBP	Gain bandwidth product	$R_L = 10\text{ k}\Omega$ , $C_L = 100\text{ pF}$	1.7	2.5		MHz
		$-40\text{ }^\circ\text{C} < T < 125\text{ }^\circ\text{C}$	1.4			
$\phi_m$	Phase margin	$R_L = 10\text{ k}\Omega$ , $C_L = 100\text{ pF}$		50		degrees
$G_m$	Gain margin	$R_L = 10\text{ k}\Omega$ , $C_L = 100\text{ pF}$		8		dB
SR	Negative slew rate	$V_{in} = 22.5\text{ to }13.5\text{ V}$ , $A_v = 1$ , 10 % to 90 %, $R_L = 10\text{ k}\Omega$ , $C_L = 100\text{ pF}$	0.57	0.88		V/ $\mu\text{s}$
		$-40\text{ }^\circ\text{C} < T < 125\text{ }^\circ\text{C}$	0.44			
	Positive slew rate	$V_{in} = 13.5\text{ to }22.5\text{ V}$ , $A_v = 1$ , 10 % to 90 %, $R_L = 10\text{ k}\Omega$ , $C_L = 100\text{ pF}$	0.60	1.00		
		$-40\text{ }^\circ\text{C} < T < 125\text{ }^\circ\text{C}$	0.44			
$e_n$	Equivalent input noise voltage	$f = 1\text{ kHz}$		20		nV/ $\sqrt{\text{Hz}}$
		$f = 0.1\text{ Hz to }10\text{ Hz}$		0.7		$\mu\text{V}_{pp}$
THD+N	Total harmonic distortion + noise	$f = 1\text{ kHz}$ , $V_{in} = 7\text{ V}_{pp}$ , $R_L = 10\text{ k}\Omega$ , $C_L = 100\text{ pF}$		0.001		%

1. Typical value is based on the  $V_{io}$  drift observed after 1000h at 125 °C extrapolated to 25 °C using Arrhenius law and assuming an activation energy of 0.7 eV. The operational amplifier is aged in follower mode configuration (see Section 4.5 Section 4.5).



Figure 3. Supply current vs. supply voltage

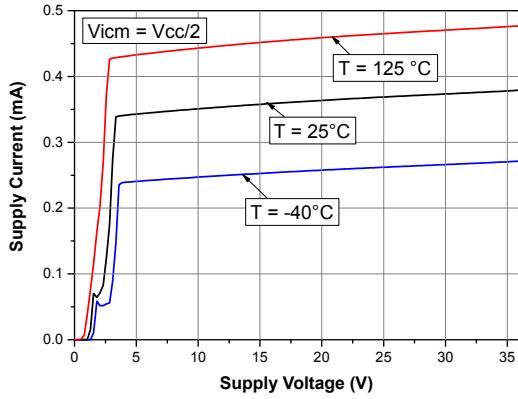

Figure 4. Input offset voltage distribution at  $V_{CC} = 4\text{ V}$

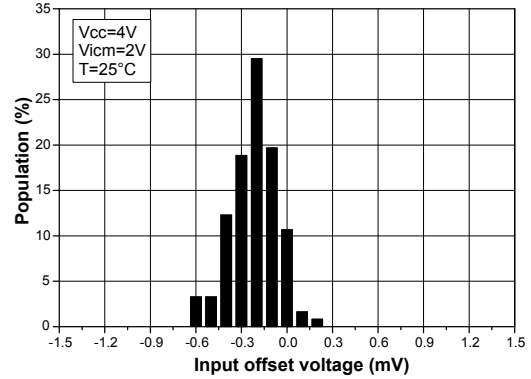

Figure 5. Input offset voltage distribution at  $V_{CC} = 12\text{ V}$

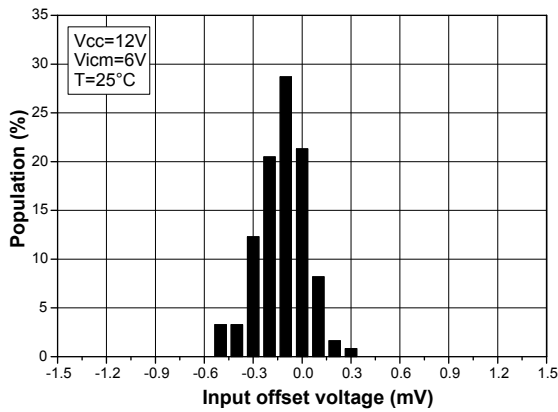

Figure 6. Input offset voltage distribution at  $V_{CC} = 36\text{ V}$

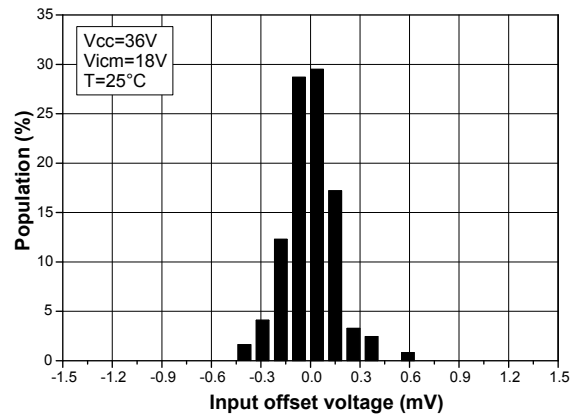

Figure 7. Input offset voltage vs. temperature at  $V_{CC} = 36\text{ V}$

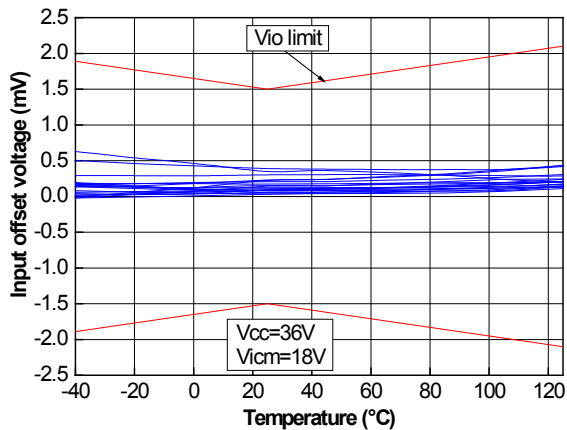

Figure 8. Input offset voltage temperature variation distribution at  $V_{CC} = 36\text{ V}$

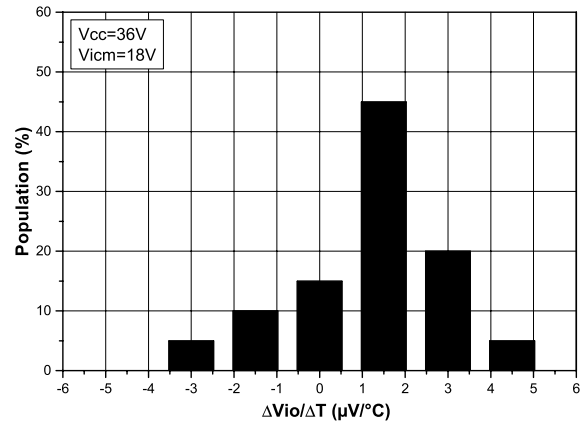

Figure 9. Input offset voltage vs. supply voltage

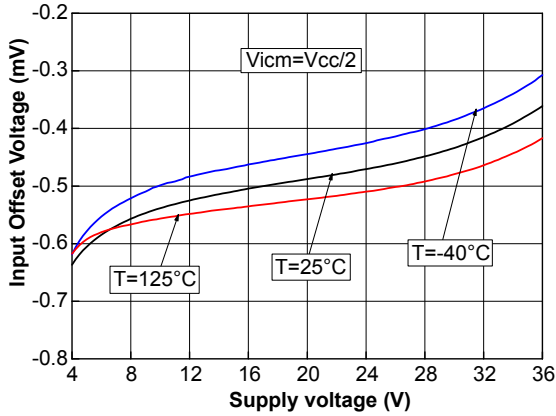

Figure 10. Input offset voltage vs. common-mode voltage at  $V_{CC} = 4\text{ V}$

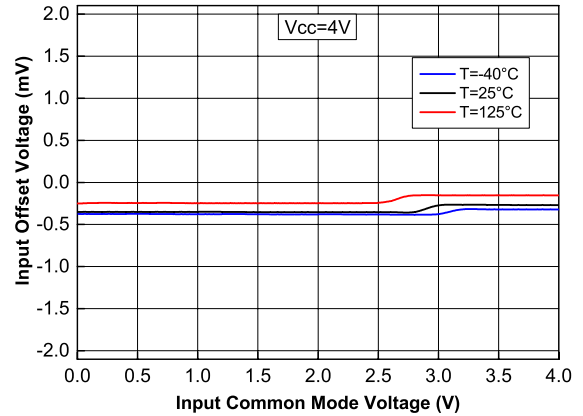

Figure 11. Input offset voltage vs. common-mode voltage at  $V_{CC} = 36\text{ V}$

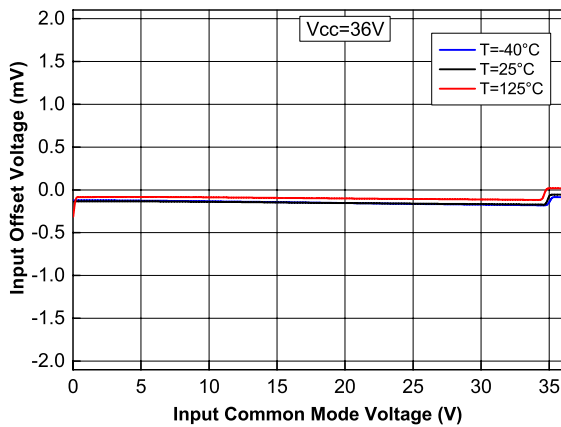

Figure 12. Input bias current vs. temperature at  $V_{ICM} = V_{CC}/2$

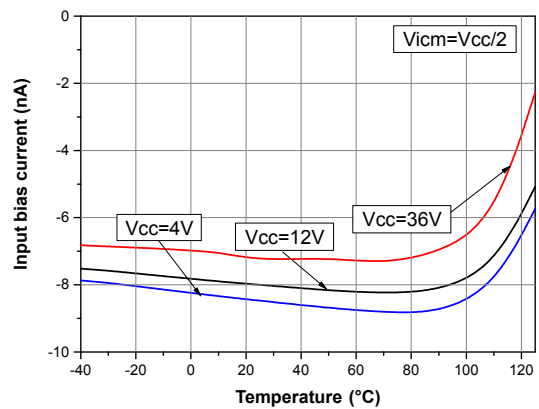

Figure 13. Input bias current vs. common-mode voltage at  $V_{CC} = 36\text{ V}$

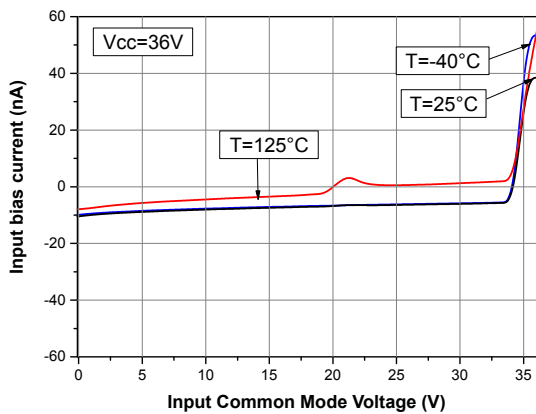

Figure 14. Output current vs. output voltage at  $V_{CC} = 4\text{ V}$

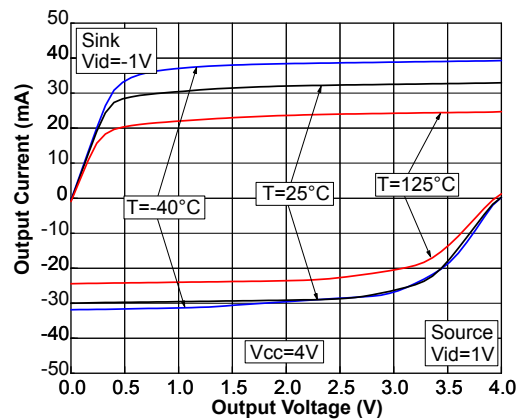

Figure 15. Output current vs. output voltage at  $V_{CC} = 36\text{ V}$

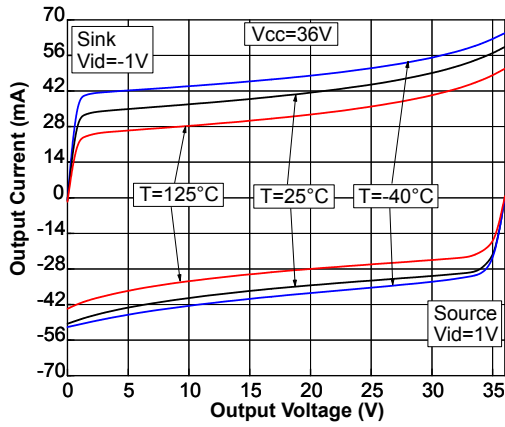

Figure 16. Output voltage (Voh) vs. supply voltage

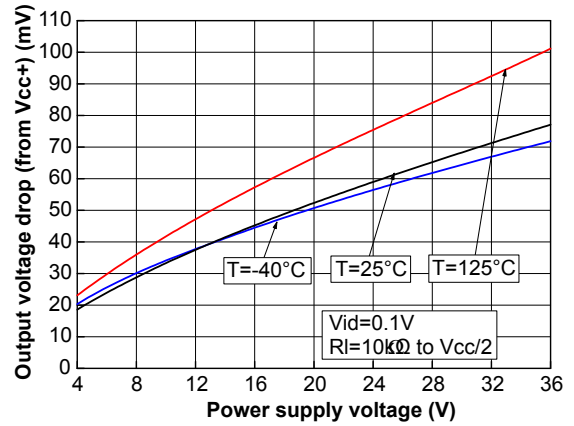

Figure 17. Output voltage (Vol) vs. supply voltage

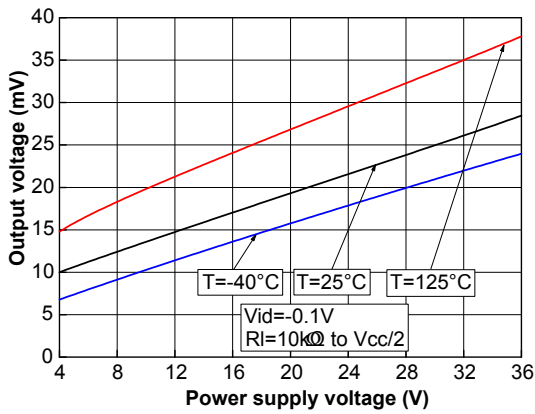

Figure 18. Negative slew rate at  $V_{CC} = 36\text{ V}$

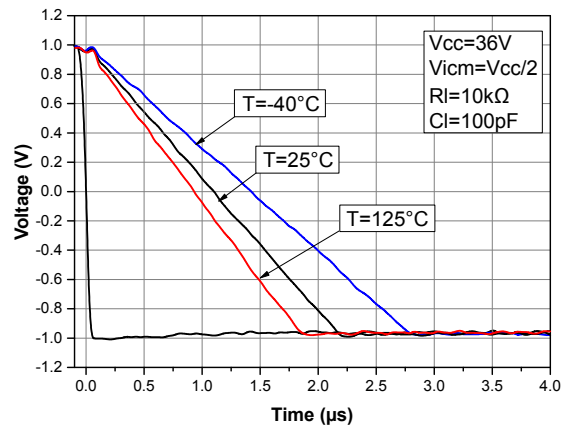

Figure 19. Positive slew rate at  $V_{CC} = 36\text{ V}$

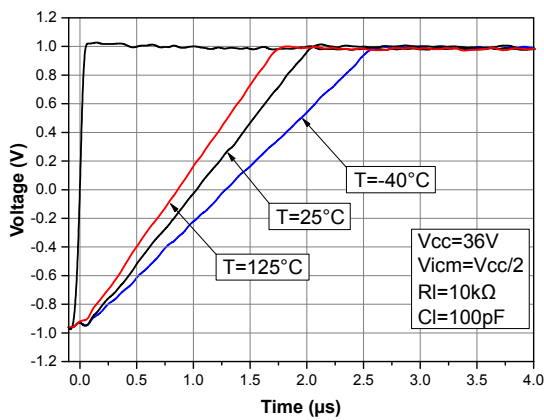

Figure 20. Slew rate vs. supply voltage

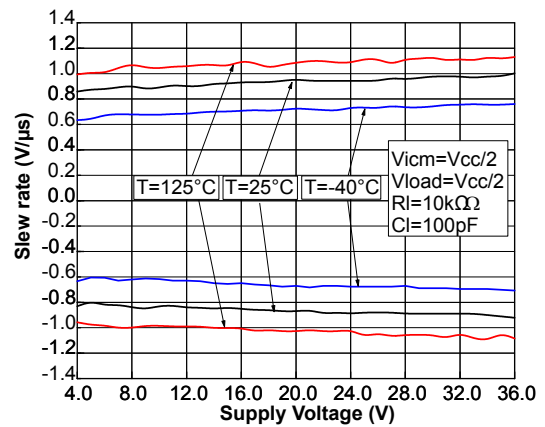

Figure 21. Bode diagram at  $V_{CC} = 4\text{ V}$

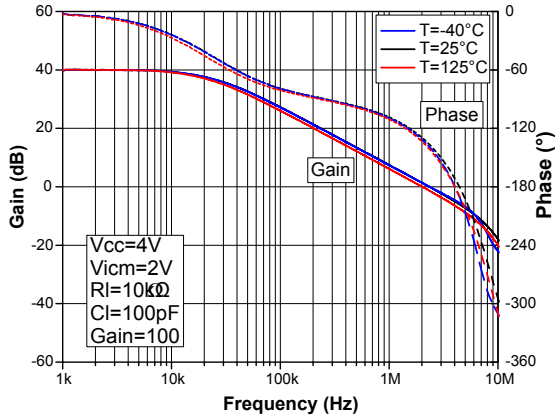

Figure 22. Bode diagram at  $V_{CC} = 36\text{ V}$

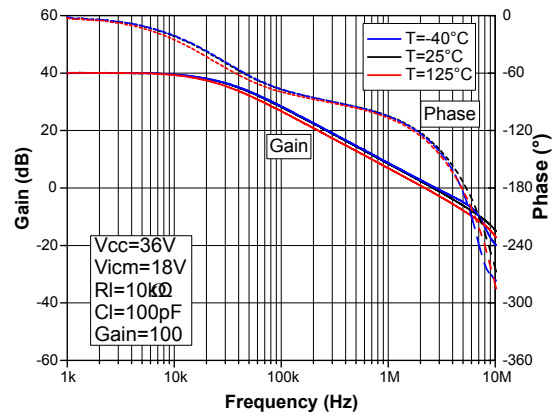

Figure 23. Phase margin vs. output current at  $V_{CC} = 4\text{ V}$

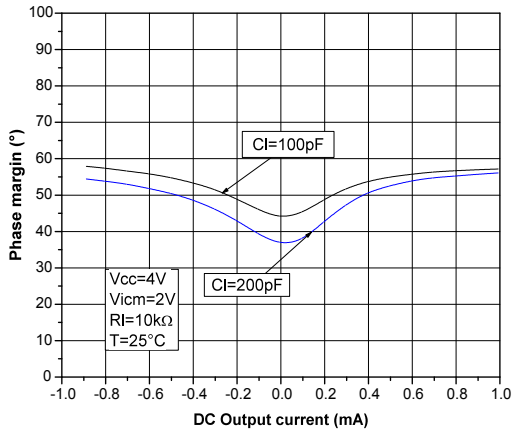

Figure 24. Phase margin vs. output current at  $V_{CC} = 36\text{ V}$

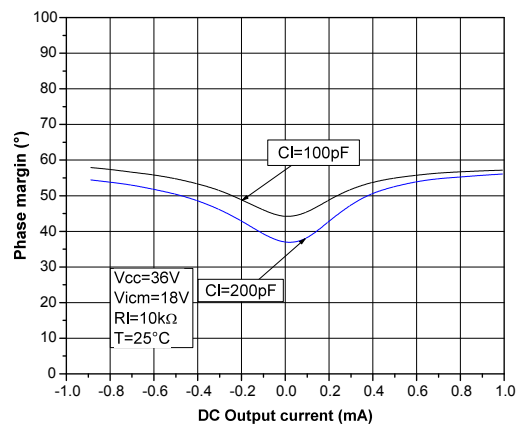

Figure 25. Phase margin vs. capacitive load

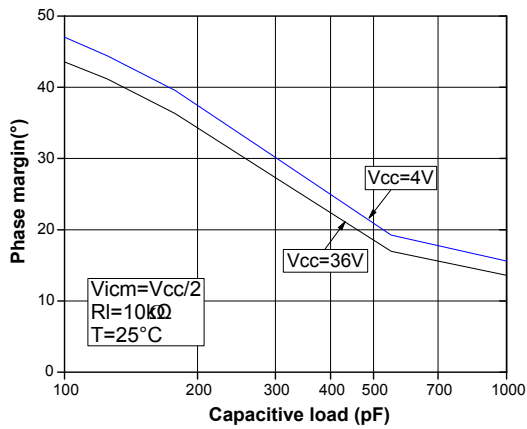
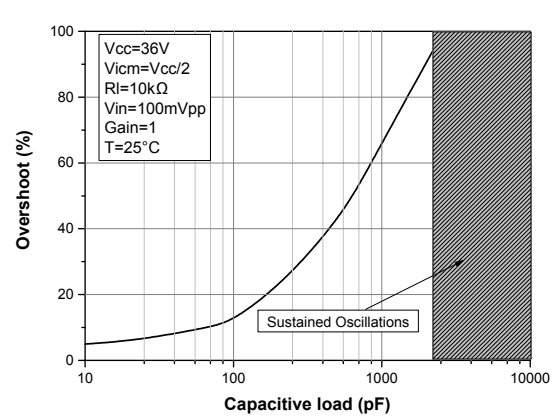
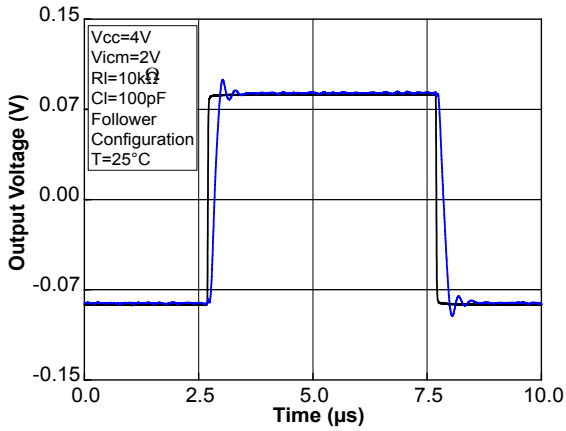

Figure 26. Overshoot vs. capacitive load at  $V_{CC} = 36\text{ V}$



**Figure 27. Small step response vs. time at  $V_{CC} = 4\text{ V}$**



**Figure 28. Output desaturation vs. time**

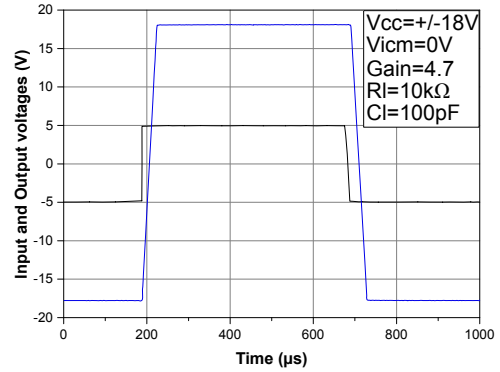

**Figure 29. Amplifier behavior close to the rails at  $V_{CC} = 36\text{ V}$**

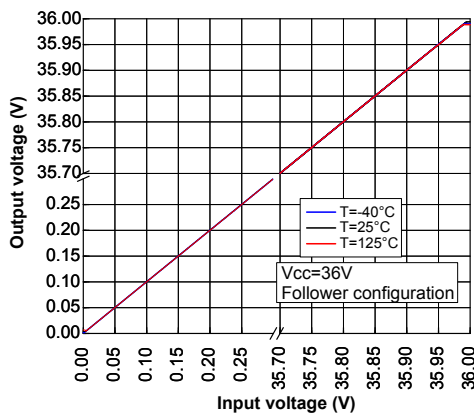

**Figure 30. Noise vs. frequency at  $V_{CC} = 36\text{ V}$**

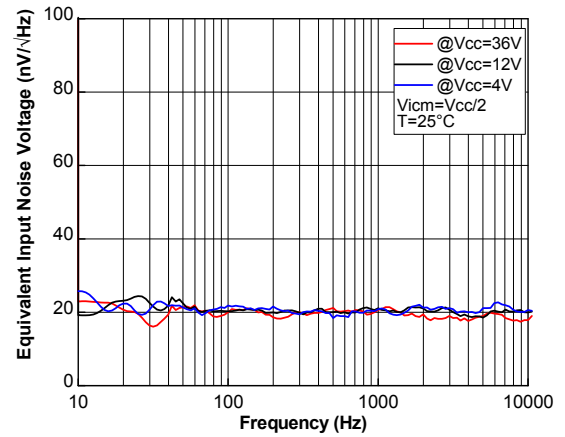

**Figure 31. Noise vs. time at  $V_{CC} = 36\text{ V}$**

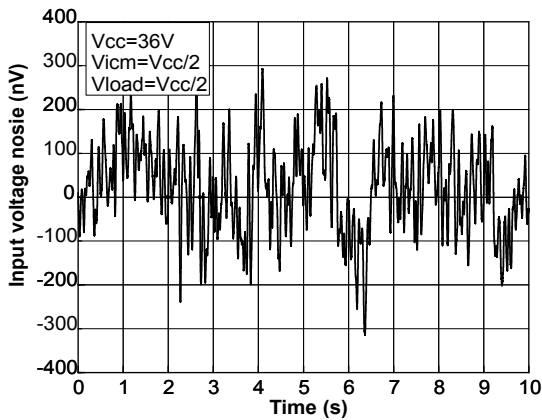

**Figure 32. THD+N vs. frequency**

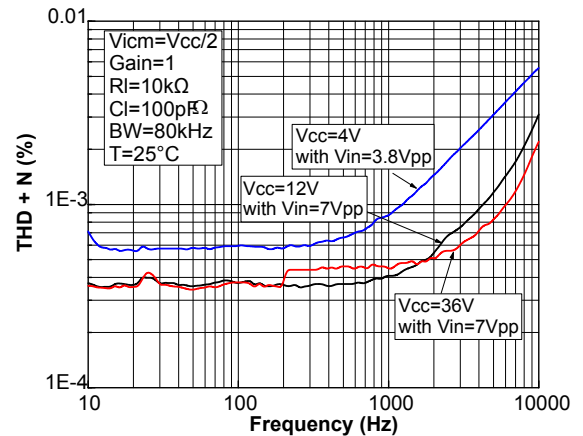

Figure 33. THD+N vs. output voltage

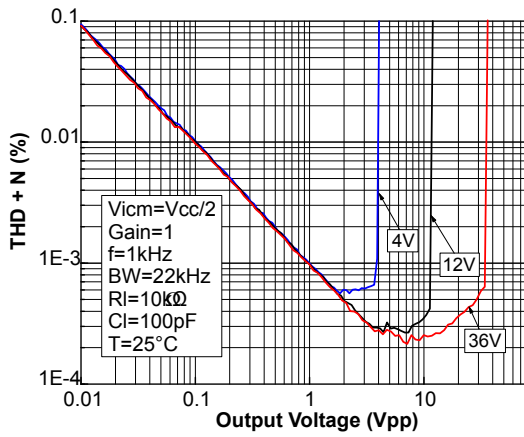

Figure 34. PSRR vs. frequency at V<sub>CC</sub> = 36 V

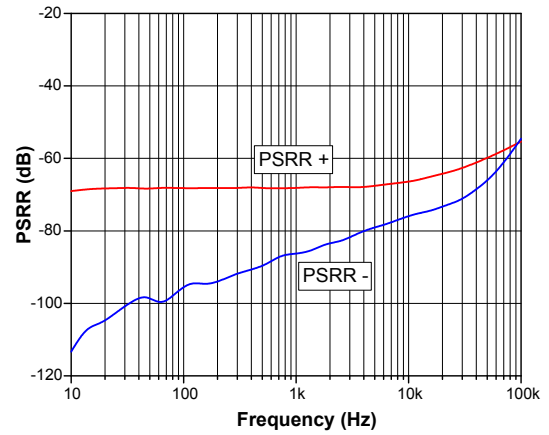
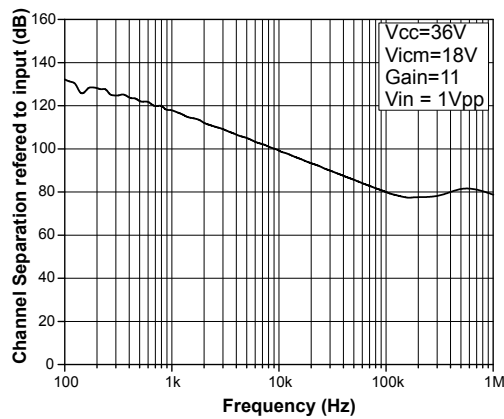

Figure 35. Channel separation vs. frequency at V<sub>CC</sub>= 36 V



## 4 Application information

### 4.1 Operating voltages

The TSB571 and TSB572 can operate from 4 V to 36 V. The parameters are fully specified for 4 V, 12 V, and 36 V power supplies. However, the parameters are stable in the full  $V_{CC}$  range. Additionally, the main specifications are guaranteed in extended temperature ranges from -40 to 125 °C.

### 4.2 Input pin voltage ranges

The TSB571 and TSB572 have an internal ESD diode protection on the inputs. These diodes are connected between the inputs and each supply rail to protect the input transistors from electrical discharge.

If the input pin voltage exceeds the power supply by 0.2 V, the ESD diodes become conductive and excessive current can flow through them. Without limitation this over current can damage the device.

In this case, it is important to limit the current to 10 mA, by adding resistance on the input pin, as shown in Figure 37. [Input current limitation](#).

Figure 36. Input current limitation

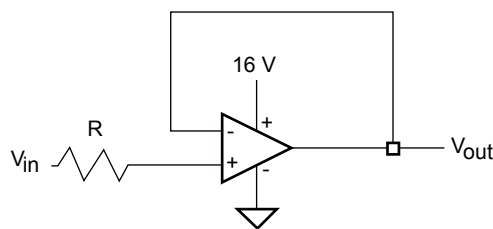

### 4.3 Rail-to-rail input

The TSB571 and TSB572 have rail-to-rail inputs. The input common mode range is extended from  $(V_{CC-}) - 0.1$  V to  $(V_{CC+}) + 0.1$  V at  $T = 25$  °C.

### 4.4 Input offset voltage drift over temperature

The maximum input voltage drift variation over temperature is defined as the offset variation related to the offset value measured at 25 °C. The operational amplifier is one of the main circuits of the signal conditioning chain, and the amplifier input offset is a major contributor to the chain accuracy. The signal chain accuracy at 25 °C can be compensated during production at application level. The maximum input voltage drift over temperature enables the system designer to anticipate the effect of temperature variations.

The maximum input voltage drift over temperature is computed using [Equation 1](#).

**Equation 1**

$$\frac{\Delta V_{io}}{\Delta T} = \max \left| \frac{V_{io}(T) - V_{io}(25\text{ °C})}{T - 25\text{ °C}} \right|$$

where  $T = -40$  °C and 125 °C.

The TSB571 and TSB572 datasheet maximum value is guaranteed by measurements on a representative sample size ensuring a  $C_{pk}$  (process capability index) greater than 1.3.

### 4.5 Long term input offset voltage drift

To evaluate product reliability, two types of stress acceleration are used:

- Voltage acceleration, by changing the applied voltage
- Temperature acceleration, by changing the die temperature (below the maximum junction temperature allowed by the technology) with the ambient temperature.

The voltage acceleration has been defined based on JEDEC results, and is defined using [Equation 2](#).

**Equation 2**

$$A_{FV} = e^{\beta \cdot (V_S - V_U)}$$

Where:

$A_{FV}$  is the voltage acceleration factor

$\beta$  is the voltage acceleration constant in 1/V, constant technology parameter ( $\beta = 1$ )

$V_S$  is the stress voltage used for the accelerated test

$V_U$  is the voltage used for the application

The temperature acceleration is driven by the Arrhenius model, and is defined in [Equation 3](#).

**Equation 3**

$$A_{FT} = e^{\frac{E_a}{k} \cdot \left( \frac{1}{T_U} - \frac{1}{T_S} \right)}$$

Where:

$A_{FT}$  is the temperature acceleration factor

$E_a$  is the activation energy of the technology based on the failure rate

$k$  is the Boltzmann constant ( $8.6173 \times 10^{-5} \text{ eV.K}^{-1}$ )

$T_U$  is the temperature of the die when  $V_U$  is used (K)

$T_S$  is the temperature of the die under temperature stress (K)

The final acceleration factor,  $A_F$ , is the multiplication of the voltage acceleration factor and the temperature acceleration factor ([Equation 4](#)).

**Equation 4**

$$A_F = A_{FT} \times A_{FV}$$

$A_F$  is calculated using the temperature and voltage defined in the mission profile of the product. The  $A_F$  value can then be used in [Equation 5](#) to calculate the number of months of use equivalent to 1000 hours of reliable stress duration.

**Equation 5**

$$\text{Months} = A_F \times 1000 \text{ h} \times 12 \text{ months} / (24 \text{ h} \times 365.25 \text{ days})$$

To evaluate the op amp reliability, a follower stress condition is used where  $V_{CC}$  is defined as a function of the maximum operating voltage and the absolute maximum rating (as recommended by JEDEC rules).

The  $V_{io}$  drift (in  $\mu\text{V}$ ) of the product after 1000 h of stress is tracked with parameters at different measurement conditions (see [Equation 6](#)).

**Equation 6**

$$V_{CC} = \max V_{op} \text{ with } V_{icm} = V_{CC} / 2$$

The long term drift parameter ( $\Delta V_{io}$ ), estimating the reliability performance of the product, is obtained using the ratio of the  $V_{io}$  (input offset voltage value) drift over the square root of the calculated number of months ([Equation 7](#)).

**Equation 7**

$$\Delta V_{io} = \frac{V_{io} \text{ drift}}{\sqrt{(\text{months})}}$$

Where  $V_{io}$  drift is the measured drift value in the specified test conditions after 1000 h stress duration.



## 4.6 Capacitive load

Driving large capacitive loads can cause stability problems. Increasing the load capacitance produces gain peaking in the frequency response, with overshoot and ringing in the step response. It is usually considered that with a gain peaking higher than 2.3 dB an op amp might become unstable.

Generally, unity gain configuration is the worst situation for stability and the ability to drive large capacitive loads. [Figure 38. Stability criteria with a serial resistor at different supply voltages](#) shows the serial resistor that must be added to the output, to make a system stable. [Figure 39. Test configuration for Riso](#) shows the test configuration using an isolation resistor, Riso.

**Figure 37. Stability criteria with a serial resistor at different supply voltages**

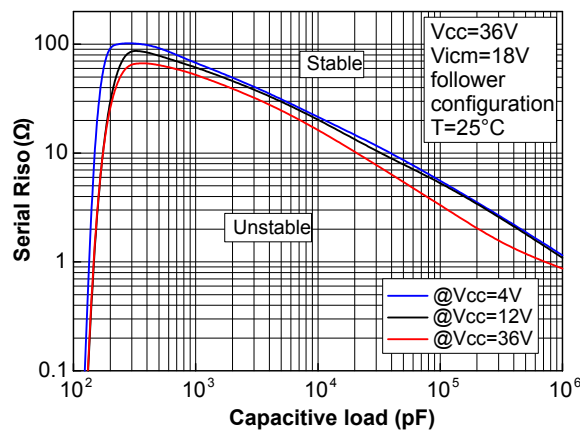

**Figure 38. Test configuration for Riso**

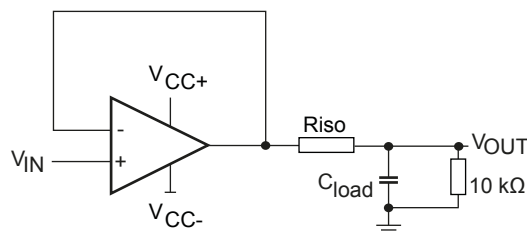

## 4.7 PCB layout recommendations

Particular attention must be paid to the layout of the PCB tracks connected to the amplifier, load, and power supply. The power and ground traces are critical as they must provide adequate energy and grounding for all circuits. The best practice is to use short and wide PCB traces to minimize voltage drops and parasitic inductance.

In addition, to minimizing parasitic impedance over the entire surface, a multi-via technique that connects the bottom and top layer ground planes together in many locations is often used.

The copper traces that connect the output pins to the load and supply pins should be as wide as possible to minimize trace resistance.

## 4.8 Optimized application recommendation

It is recommended to place a 22 nF capacitor as close as possible to the supply pin. A good decoupling will help to reduce electromagnetic interference impact.

## 5 Package information

In order to meet environmental requirements, ST offers these devices in different grades of **ECOPACK** packages, depending on their level of environmental compliance. ECOPACK specifications, grade definitions and product status are available at: [www.st.com](http://www.st.com). ECOPACK is an ST trademark.

### 5.1 SOT23-5 package information

Figure 39. SOT23-5 package outline

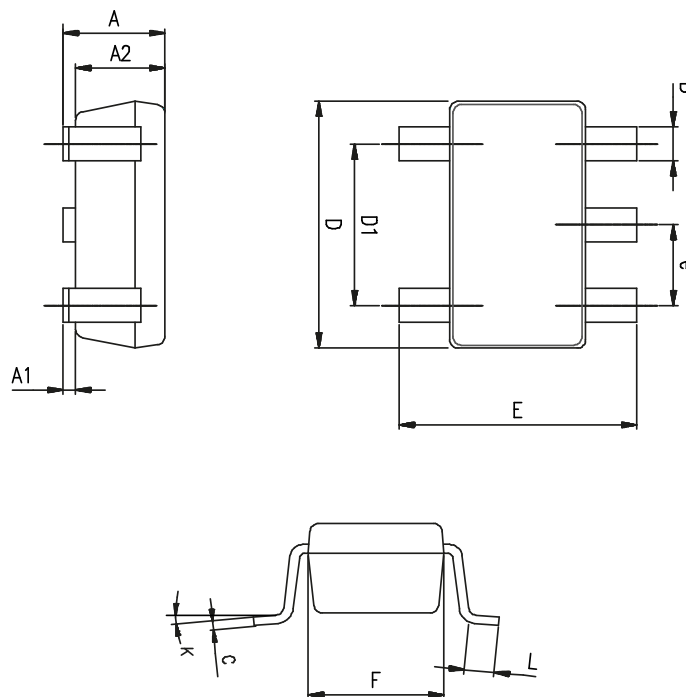

**Table 8. SOT23-5 package mechanical data**

Ref.	Dimensions					
	Millimeters			Inches		
	Min.	Typ.	Max.	Min.	Typ.	Max.
A	0.90	1.20	1.45	0.035	0.047	0.057
A1			0.15			0.006
A2	0.90	1.05	1.30	0.035	0.041	0.051
B	0.35	0.40	0.50	0.014	0.016	0.020
C	0.09	0.15	0.20	0.004	0.006	0.020
D	2.80	2.90	3.00	0.110	0.114	0.118
D1		1.90			0.075	
e		0.95			0.037	
E	2.60	2.80	3.00	0.102	0.110	0.118
F	1.50	1.60	1.75	0.059	0.063	0.069
L	0.10	0.35	0.60	0.004	0.014	0.024
K	0°		10°	0°		10°

## 5.2 MiniSO8 package information

Figure 40. MiniSO8 package outline

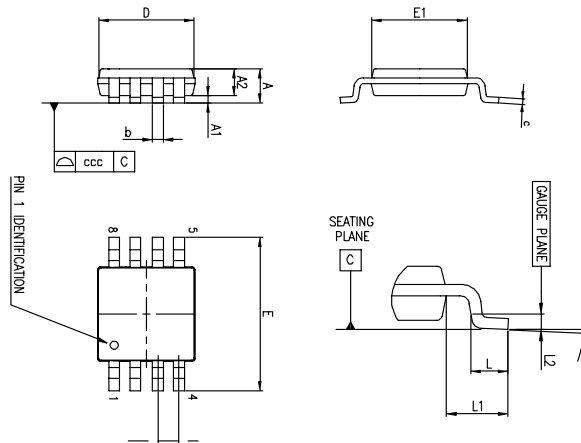

Table 9. MiniSO8 package mechanical data

Ref.	Dimensions					
	Millimeters			Inches		
	Min.	Typ.	Max.	Min.	Typ.	Max.
A			1.1			0.043
A1	0		0.15	0		0.0006
A2	0.75	0.85	0.95	0.030	0.033	0.037
b	0.22		0.40	0.009		0.016
c	0.08		0.23	0.003		0.009
D	2.80	3.00	3.20	0.11	0.118	0.126
E	4.65	4.90	5.15	0.183	0.193	0.203
E1	2.80	3.00	3.10	0.11	0.118	0.122
e		0.65			0.026	
L	0.40	0.60	0.80	0.016	0.024	0.031
L1		0.95			0.037	
L2		0.25			0.010	
k	0°		8°	0°		8°
ccc			0.10			0.004

### 5.3 DFN8 3x3 package information

Figure 41. DFN8 3x3 package outline and mechanical data

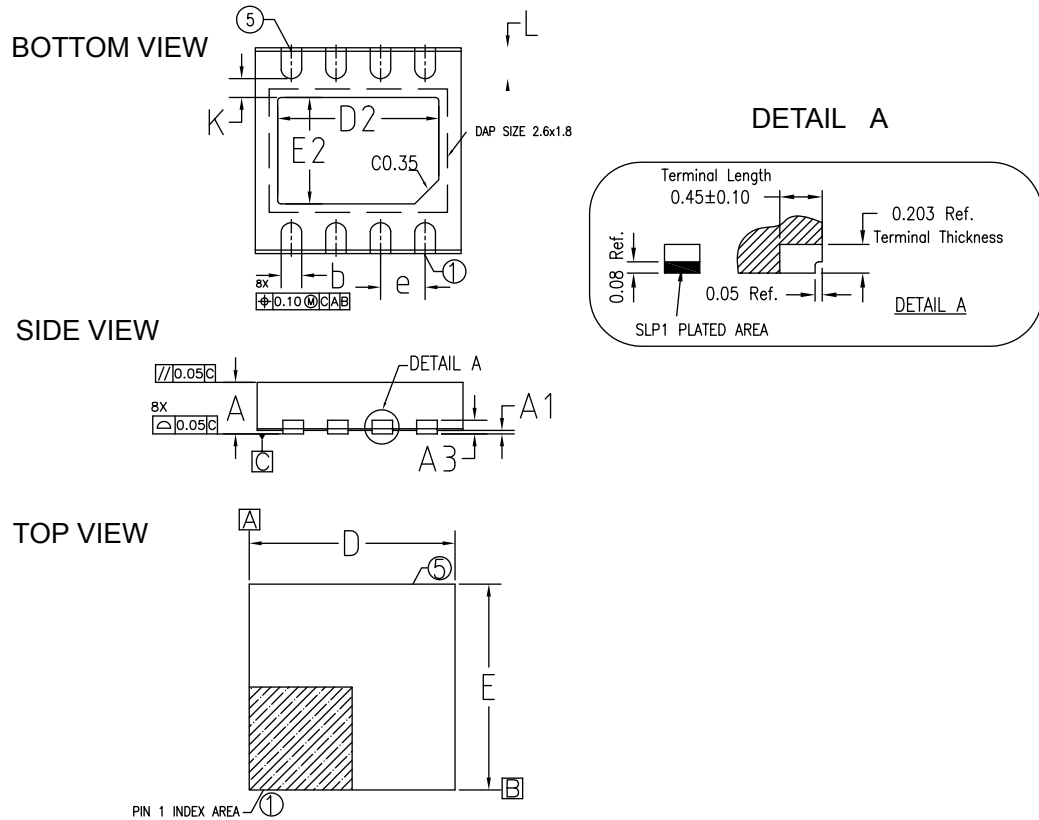
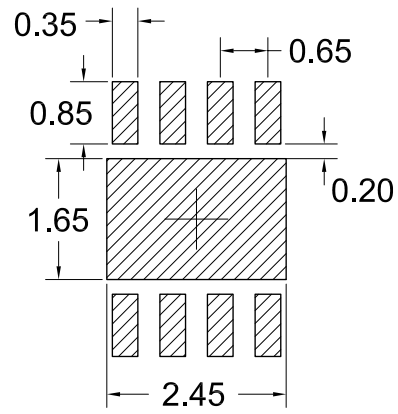

Table 10. DFN8 3x3 mechanical data

Symbol	mm		
	Min.	Typ.	Max.
A	0.70	0.75	0.80
A1	0.0		0.05
A3		0.20 Ref.	
b	0.25	0.30	0.35
D	2.95	3.00	3.05
D2	2.25	2.35	2.45
e		0.65 BSC	
E	2.95	3.00	3.05
E2	1.45	1.55	1.65
L	0.35	0.45	0.55
K		2.75 Ref.	
N		8	

Figure 42. DFN8 3x3 footprint data



## 5.4 SO-8 package information

**Figure 43. SO-8 package outline**

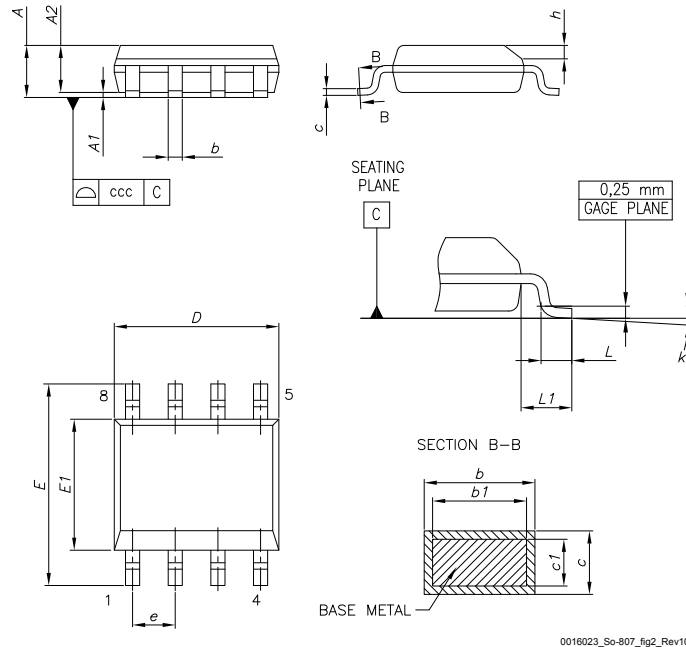

0016023\_So-807\_fig2\_Rev10

**Table 11. SO-8 mechanical data**

Dim.	mm		
	Min.	Typ.	Max.
A			1.75
A1	0.10		0.25
A2	1.25		
b	0.31		0.51
b1	0.28		0.48
c	0.10		0.25
c1	0.10		0.23
D	4.80	4.90	5.00
E	5.80	6.00	6.20
E1	3.80	3.90	4.00
e		1.27	
h	0.25		0.50
L	0.40		1.27
L1		1.04	
L2		0.25	
k	0°		8°
ccc			0.10

## 6 Ordering information

**Table 12. Order codes**

Order code	Temperature range	Package	Packing	Marking
TSB571ILT	-40 °C to +125 °C	SOT23-5	Tape and reel	K31
TSB572IYLT <sup>(1)</sup>				K32
TSB572IQ2T	-40 °C to 125 °C	DFN8 3x3	Tape and reel	K31
TSB572IYQ2T <sup>(1)</sup>				K32
TSB572IST		MiniSO8		K31
TSB572IYST <sup>(1)</sup>				K32
TSB572IDT		SO8 package		TSB572I

1. Automotive qualification according to AEC-Q100.



## Revision history

**Table 13. Document revision history**

Date	Version	Changes
12-Oct-2015	1	Initial release
17-Dec-2015	2	Section 2: "Absolute maximum ratings and operating conditions": updated ESD, MM value. Section 6: "Ordering information": removed footnote (1) from order code TSB572IQ2T
26-Jun-2017	3	In <i>Table 1: "Absolute maximum ratings"</i> : - Updated Latch-up immunity Parameter Value - updated footnote (3)
10-Nov-2017	4	Added: new SO-8 Package information and new order code TSB572IDT Section 6 Ordering information
26-Mar-2018	5	Updated: Section 5.2 DFN8 3x3 package information
22-Jul-2019	6	Added the root part number TSB571 and updated the whole document accordingly.

## Contents

<b>1</b>	<b>Package pin connections</b> .....	<b>2</b>
<b>2</b>	<b>Absolute maximum ratings and operating conditions</b> .....	<b>4</b>
<b>3</b>	<b>Electrical characteristics</b> .....	<b>5</b>
<b>4</b>	<b>Application information</b> .....	<b>15</b>
4.1	Operating voltages .....	15
4.2	Input pin voltage ranges .....	15
4.3	Rail-to-rail input .....	15
4.4	Input offset voltage drift over temperature .....	15
4.5	Long term input offset voltage drift .....	15
4.6	Capacitive load .....	16
4.7	PCB layout recommendations .....	17
4.8	Optimized application recommendation .....	17
<b>5</b>	<b>Package information</b> .....	<b>18</b>
5.1	SOT23-5 package information .....	18
5.2	MiniSO8 package information .....	20
5.3	DFN8 3x3 package information .....	20
5.4	SO-8 package outline .....	23
<b>6</b>	<b>Ordering information</b> .....	<b>24</b>
	<b>Revision history</b> .....	<b>25</b>

## List of tables

<b>Table 1.</b>	Pin description (SOT23-5) . . . . .	2
<b>Table 2.</b>	Pin description (miniSO8/SO8/DFN8) . . . . .	3
<b>Table 3.</b>	Absolute maximum ratings . . . . .	4
<b>Table 4.</b>	Operating conditions . . . . .	4
<b>Table 5.</b>	Electrical characteristics at $V_{CC} = 4\text{ V}$ , $V_{ICM} = V_{CC}/2$ , $T_{amb} = 25\text{ °C}$ , and $R_L$ connected to $V_{CC}/2$ (unless otherwise specified) . . . . .	5
<b>Table 6.</b>	Electrical characteristics at $V_{CC} = 12\text{ V}$ , $V_{ICM} = V_{CC}/2$ , $T_{amb} = 25\text{ °C}$ , and $R_L$ connected to $V_{CC}/2$ (unless otherwise specified) . . . . .	6
<b>Table 7.</b>	Electrical characteristics at $V_{CC} = 36\text{ V}$ , $V_{ICM} = V_{CC}/2$ , $T_{amb} = 25\text{ °C}$ , and $R_L$ connected to $V_{CC}/2$ (unless otherwise specified) . . . . .	7
<b>Table 8.</b>	SOT23-5 package mechanical data . . . . .	19
<b>Table 9.</b>	MiniSO8 package mechanical data . . . . .	20
<b>Table 10.</b>	DFN8 3x3 mechanical data . . . . .	21
<b>Table 11.</b>	SO-8 mechanical data . . . . .	23
<b>Table 12.</b>	Order codes . . . . .	24
<b>Table 13.</b>	Document revision history . . . . .	25

## List of figures

<b>Figure 1.</b>	Pin connections (top view) . . . . .	2
<b>Figure 2.</b>	Pin connections for each package (top view) . . . . .	2
<b>Figure 3.</b>	Supply current vs. supply voltage . . . . .	9
<b>Figure 4.</b>	Input offset voltage distribution at $V_{CC} = 4\text{ V}$ . . . . .	9
<b>Figure 5.</b>	Input offset voltage distribution at $V_{CC} = 12\text{ V}$ . . . . .	9
<b>Figure 6.</b>	Input offset voltage distribution at $V_{CC} = 36\text{ V}$ . . . . .	9
<b>Figure 7.</b>	Input offset voltage vs. temperature at $V_{CC} = 36\text{ V}$ . . . . .	9
<b>Figure 8.</b>	Input offset voltage temperature variation distribution at $V_{CC} = 36\text{ V}$ . . . . .	9
<b>Figure 9.</b>	Input offset voltage vs. supply voltage . . . . .	10
<b>Figure 10.</b>	Input offset voltage vs. common-mode voltage at $V_{CC} = 4\text{ V}$ . . . . .	10
<b>Figure 11.</b>	Input offset voltage vs. common-mode voltage at $V_{CC} = 36\text{ V}$ . . . . .	10
<b>Figure 12.</b>	Input bias current vs. temperature at $V_{ICM} = V_{CC}/2$ . . . . .	10
<b>Figure 13.</b>	Input bias current vs. common-mode voltage at $V_{CC} = 36\text{ V}$ . . . . .	10
<b>Figure 14.</b>	Output current vs. output voltage at $V_{CC} = 4\text{ V}$ . . . . .	10
<b>Figure 15.</b>	Output current vs. output voltage at $V_{CC} = 36\text{ V}$ . . . . .	11
<b>Figure 16.</b>	Output voltage (Voh) vs. supply voltage . . . . .	11
<b>Figure 17.</b>	Output voltage (Vol) vs. supply voltage . . . . .	11
<b>Figure 18.</b>	Negative slew rate at $V_{CC} = 36\text{ V}$ . . . . .	11
<b>Figure 19.</b>	Positive slew rate at $V_{CC} = 36\text{ V}$ . . . . .	11
<b>Figure 20.</b>	Slew rate vs. supply voltage . . . . .	11
<b>Figure 21.</b>	Bode diagram at $V_{CC} = 4\text{ V}$ . . . . .	12
<b>Figure 22.</b>	Bode diagram at $V_{CC} = 36\text{ V}$ . . . . .	12
<b>Figure 23.</b>	Phase margin vs. output current at $V_{CC} = 4\text{ V}$ . . . . .	12
<b>Figure 24.</b>	Phase margin vs. output current at $V_{CC} = 36\text{ V}$ . . . . .	12
<b>Figure 25.</b>	Phase margin vs. capacitive load . . . . .	12
<b>Figure 26.</b>	Overshoot vs. capacitive load at $V_{CC} = 36\text{ V}$ . . . . .	12
<b>Figure 27.</b>	Small step response vs. time at $V_{CC} = 4\text{ V}$ . . . . .	13
<b>Figure 28.</b>	Output desaturation vs. time . . . . .	13
<b>Figure 29.</b>	Amplifier behavior close to the rails at $V_{CC} = 36\text{ V}$ . . . . .	13
<b>Figure 30.</b>	Noise vs. frequency at $V_{CC} = 36\text{ V}$ . . . . .	13
<b>Figure 31.</b>	Noise vs. time at $V_{CC} = 36\text{ V}$ . . . . .	13
<b>Figure 32.</b>	THD+N vs. frequency . . . . .	13
<b>Figure 33.</b>	THD+N vs. output voltage . . . . .	14
<b>Figure 34.</b>	PSRR vs. frequency at $V_{CC} = 36\text{ V}$ . . . . .	14
<b>Figure 35.</b>	Channel separation vs. frequency at $V_{CC} = 36\text{ V}$ . . . . .	14
<b>Figure 36.</b>	Input current limitation . . . . .	15
<b>Figure 37.</b>	Stability criteria with a serial resistor at different supply voltages . . . . .	17
<b>Figure 38.</b>	Test configuration for Riso . . . . .	17
<b>Figure 39.</b>	SOT23-5 package outline . . . . .	18
<b>Figure 40.</b>	MiniSO8 package outline . . . . .	20
<b>Figure 41.</b>	DFN8 3x3 package outline and mechanical data . . . . .	21
<b>Figure 42.</b>	DFN8 3x3 footprint data . . . . .	22
<b>Figure 43.</b>	SO-8 package outline . . . . .	23

**IMPORTANT NOTICE – PLEASE READ CAREFULLY**

STMicroelectronics NV and its subsidiaries (“ST”) reserve the right to make changes, corrections, enhancements, modifications, and improvements to ST products and/or to this document at any time without notice. Purchasers should obtain the latest relevant information on ST products before placing orders. ST products are sold pursuant to ST’s terms and conditions of sale in place at the time of order acknowledgement.

Purchasers are solely responsible for the choice, selection, and use of ST products and ST assumes no liability for application assistance or the design of Purchasers’ products.

No license, express or implied, to any intellectual property right is granted by ST herein.

Resale of ST products with provisions different from the information set forth herein shall void any warranty granted by ST for such product.

ST and the ST logo are trademarks of ST. For additional information about ST trademarks, please refer to [www.st.com/trademarks](http://www.st.com/trademarks). All other product or service names are the property of their respective owners.

Information in this document supersedes and replaces information previously supplied in any prior versions of this document.

© 2019 STMicroelectronics – All rights reserved

## Данный компонент на территории Российской Федерации

### Вы можете приобрести в компании MosChip.

Для оперативного оформления запроса Вам необходимо перейти по данной ссылке:

<http://moschip.ru/get-element>

Вы можете разместить у нас заказ для любого Вашего проекта, будь то серийное производство или разработка единичного прибора.

В нашем ассортименте представлены ведущие мировые производители активных и пассивных электронных компонентов.

Нашей специализацией является поставка электронной компонентной базы двойного назначения, продукции таких производителей как XILINX, Intel (ex.ALTERA), Vicor, Microchip, Texas Instruments, Analog Devices, Mini-Circuits, Amphenol, Glenair.

Сотрудничество с глобальными дистрибьюторами электронных компонентов, предоставляет возможность заказывать и получать с международных складов практически любой перечень компонентов в оптимальные для Вас сроки.

На всех этапах разработки и производства наши партнеры могут получить квалифицированную поддержку опытных инженеров.

Система менеджмента качества компании отвечает требованиям в соответствии с ГОСТ Р ИСО 9001, ГОСТ РВ 0015-002 и ЭС РД 009

### Офис по работе с юридическими лицами:

105318, г.Москва, ул.Щербаковская д.3, офис 1107, 1118, ДЦ «Щербаковский»

Телефон: +7 495 668-12-70 (многоканальный)

Факс: +7 495 668-12-70 (доб.304)

E-mail: [info@moschip.ru](mailto:info@moschip.ru)

Skype отдела продаж:

moschip.ru

moschip.ru\_4

moschip.ru\_6

moschip.ru\_9