

RoHS  
Ready 



# SOLARLOK Photovoltaic Interconnection System

Table of Contents

The SOLARLOK Concept .....	1
Large Junction Box – Serial Interconnection .....	2
5-Rail Junction Box – Serial Interconnection .....	3
Medium Junction Box – Serial Interconnection .....	4
Small Junction Box – Serial Interconnection .....	6
Eco Junction Box – Serial Interconnection .....	7
Slim Junction Box – Serial Interconnection .....	8
Micro Junction Box – Serial Interconnection .....	9
Junction Boxes for Building integrated PV Applications (BiPV) .....	10
Solar Labels .....	12
Combiner Box .....	13
Cable Coupler – Standard Line .....	14
Cable Coupler – Slim Line .....	15
T-Branch Connector .....	16
DC Converter Receptacle .....	17
AC Inverter Connector .....	18
Field Wiring, Switching and Protection .....	19
Solar Cable – TÜV and UL certified .....	20
Solar Cable, 1-Pole .....	21
Wiring Example with Extension Cables .....	22
Grounding Solutions .....	23
Interconnection Examples .....	24
Application Tooling .....	26
Contacts .....	28
Assembly and Installation Guidelines .....	29
Technical Data .....	33
Numerical Index .....	34
Restriction on the Use of Hazardous Substances (RoHS) .....	36

**Product Information Center (PIC)**

Our PIC team are there to help with any further questions. With our experienced employees in the Product Information Center (PIC) we can offer you a reliable source of information and support for your technical queries.

**To contact your local Tyco Electronics subsidiary, please refer to the address page at the back of this catalog.**

**Product und Machine Literature**

Order quickly and easily by fax:

**For Fax No. see address page entry for your specific region.**

A large product range has extensive product literature. You can request flyers, catalogs and brochures for each of the product sectors of relevance to you.

**Tyco Electronics Online**

Internet Homepage:  
**[www.tycoelectronics.com/solar](http://www.tycoelectronics.com/solar)**

Electronic Internet Catalog:  
**<http://catalog.tycoelectronics.com>**



Our website is more than an Internet guide. It is constantly being added to and is an innovative and interactive source for applications tips, product updates and technical information of all types. With our innovative StepSearch software, which has been perfected over a period of several years you can conveniently surf your way through all our products.

## The SOLARLOK Concept

**System Features**
**Junction Box**

- Variable wiring options
- Easily accessible
- Simple, fast and cost-effective assembly
- Flat, low profile design
- High current carrying capacity
- Good thermal balance
- Connectorized or direct wire configurations
- Up to four outputs possible
- Up to six internal rails
- Customer-specific solutions
- TÜV and UL approved

**Connector**

- Simple on-site processing
- Mating safety provided by keyed housings
- Semi-automatic assembly capability possible
- Multiple plugging and unplugging cycles
- Accommodates solar cable with different insulation diameters
- High current carrying capacity
- Wide temperature operating range
- TÜV and UL approved

**Solar Cable**

- Dual wall insulation
- Electron beam cross-linked
- Excellent resistance to U.V., water, ozone, fluids, salt, general weathering
- Excellent resistance to abrasion
- Halogen free, flame retardant, low toxicity
- Very low smoke emissions
- Excellent flexibility and stripping performance
- Different cable diameters
- Operating Temperature from -40 °C up to +125 °C
- Voltage Rating up to 1800 V DC
- Short circuit resistant up to +250 °C
- TÜV and UL approved

**Simple and Reliable System Interconnection of Individual Solar Modules Right to the DC/AC Converters**

Market expansion of the formerly regulated energy supply sector, increased global environmental awareness and governments committing themselves to more stringent environmental targets have opened up new opportunities for the photovoltaic industry.

Having served a niche market in the past, the photovoltaics industry now has the opportunity to move into mass production, realizing economies of scale and gaining a greater market share of the world's energy mix.

Tyco Electronics will be contributing to the establishment of this environmentally-friendly technology with the introduction of its SOLARLOK connector system.

SOLARLOK delivers a flexible system solution for easy and reliable interconnections from photovoltaic modules to the DC/AC converter. The entire system concept is based on cost-effective and reliable processing of individual interconnection system components. This significantly reduces installation costs of the solar energy system.

The junction box concept is based on a flexible, open system structure, which allows serial as well as parallel interconnection via direct wire connect or separable connectors. Within the junction box, up to six termination places rails are available for photovoltaic foil connection.

The male and female cable coupler was designed for high voltage and high current-carrying capacity in addition to the well-established IP 67 sealing requirement in the photovoltaic industry. Mating safety is provided by polarity keyed housings, fully shrouded contacts, reliable high cycle life, and squeeze to release connection system. In addition, a wide temperature range and fulfillment of worldwide standards for photovoltaic connection systems complement the robust product specification.

The design of the male and female receptacle for the junction box and the DC/AC converter follow the cable coupler "click philosophy" for quick and secure mating even in difficult mounting positions.

If required by the customer, the junction box can be delivered pre-configured with diodes, jumpers, plug connectors, and solar cable pigtailed.

Large Junction Box – Serial Interconnection



All mentioned versions are standard. Plus-connection see drawing.

Junction Box with Mounted Cable and Connectors

Part Number	Contact Rails	Diodes	Rated Current (IEC 61215, Edition 2) (Ampere)	Cable Length (mm)	Wire Size (mm <sup>2</sup> )
1740300-2	6	5	6.0	1,000	4.0
1987294-2	6	5	8.5	1,000	4.0
1987254-2	6	5	13.0	1,000	4.0
1740077-1	4	3	6.0	1,000	4.0
1740077-3	4	3	8.5	1,000	4.0
on request	4	3	13.0	1,000	4.0

Junction Box with Connector Outlet

Part Number	Contact Rails	Diodes	Rated Current (IEC 61215, Edition 2) (Ampere)
3-1394723-0	6	5	6.0
6-1394723-5	6	5	8.5
6-1394723-6	6	5	13.0
2-1394723-4	4	3	6.0
on request	4	3	8.5
5-1394723-3	4	3	13.0

Junction Box with Extended Wiring Space



Special Versions

Part Number	Contact Rails	Diodes	Rated Current (IEC 61215, Edition 2) (Ampere)	Cable Length (mm)	Wire Size (mm <sup>2</sup> )	Comments
1981988-1	6	5	8.5	1,000	4.0	Junction Box with extended wiring space
1981987-1	6	5	13.0	1,000	4.0	

Standard mounting on the panel with silicone glue (approved types see application specification).  
Optional with double-sided adhesive tape (specifications of the adhesive tape can be found in the datasheets of the manufacturer).

5-Rail Junction Box – Serial Interconnection



All mentioned versions are standard. Plus-connection see drawing.  
TÜV and UL pending.

Junction Box with Mounted Cable and Connectors

Part Number	Contact Rails	Diodes	Rated Current (IEC 61215, Edition 2) (Ampere)	Cable Length (mm)	Wire Size (mm <sup>2</sup> )
1987858-3	5	4	8.5	1,000	4.0
1987982-3	5	4	13.0	1,000	4.0

Junction Box with Connector Outlet

Part Number	Contact Rails	Diodes	Rated Current (IEC 61215, Edition 2) (Ampere)
on request	5	4	8.5
on request	5	4	13.0

Standard mounting on the panel with silicone glue (approved types see application specification).  
Optional with double-sided adhesive tape (specifications of the adhesive tape can be found in the datasheets of the manufacturer).

Medium Junction Box – Serial Interconnection



All mentioned versions are standard. Plus-connection see drawing.

Junction Box with Mounted Cable and Connectors

Part Number	Contact Rails	Diodes	Rated Current (IEC 61215, Edition 2) (Ampere)	Cable Length (mm)	Wire Size (mm <sup>2</sup> )
1987002-4	4	3	6.0	1,000	4.0
1740699-6	4	3	8.5	1,000	4.0
1740971-2	4	3	13.0	1,000	4.0

Junction Box with Connector Outlet

Part Number	Contact Rails	Diodes	Rated Current (IEC 61215, Edition 2) (Ampere)
1987003-3	4	3	6.0
1740700-1	4	3	8.5
1740972-1	4	3	13.0

Standard mounting on the panel with silicone glue (approved types see application specification).  
Optional with double-sided adhesive tape (specifications of the adhesive tape can be found in the datasheets of the manufacturer).

Medium Junction Box – Serial Interconnection – Special Versions

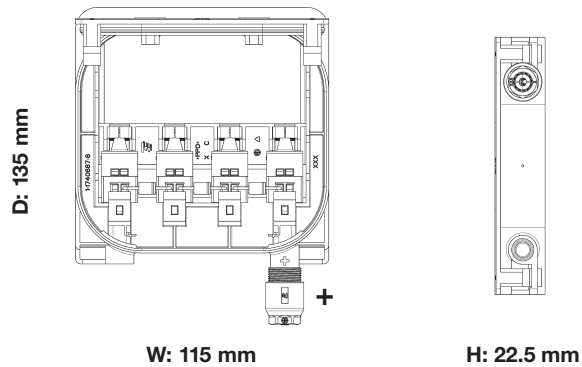

All mentioned versions are standard. Plus-connection see drawing.

Junction Box with Mounted Cable and Connectors

Part Number	Contact Rails	Diodes	Rated Current (IEC 61215, Edition 2) (Ampere)	Cable Length (mm)	Wire Size (mm <sup>2</sup> )	Comments
3-1740699-9	4	3	8.5	1,000	4.0	Male Contact (neutral) right, left closed
3-1740699-8	4	3	8.5	1,000	4.0	Female Contact (neutral) left, right closed
1987994-1	4	3	13.0	1,000	4.0	Male Contact (neutral) right, left closed
1987995-1	4	3	13.0	1,000	4.0	Female Contact (neutral) left, right closed

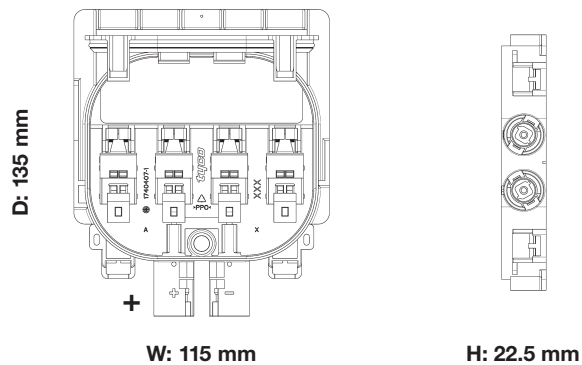

Inside Style

Part Number	Contact Rails	Diodes	Rated Current (IEC 61215, Edition 2) (Ampere)	Cable Length (mm)	Wire Size (mm <sup>2</sup> )	Comments
1740657-8	4	3	8.5	1,000	4.0	with Mounted Cable
1740658-1	4	3	8.5	1,000	4.0	with Connector Outlet

Standard mounting on the panel with silicone glue (approved types see application specification).  
Optional with double-sided adhesive tape (specifications of the adhesive tape can be found in the datasheets of the manufacturer).

**Small Junction Box – Serial Interconnection**



All mentioned versions are standard. Plus-connection see drawing.

**Junction Box with Mounted Cable and Connectors**

Part Number	Contact Rails	Diodes	Rated Current (IEC 61215, Edition 2) (Ampere)	Cable Length (mm)	Wire Size (mm <sup>2</sup> )
1740425-5	3	2	6.5	1,000	4.0
1987225-6	3	2	10.5	1,000	4.0
1987252-1	3	2	14.0	1,000	4.0

**Junction Box with Connector Outlet**

Part Number	Contact Rails	Diodes	Rated Current (IEC 61215, Edition 2) (Ampere)
1418867-6	3	2	6.5
1987459-1	3	2	10.5
1987777-1	3	2	14.0

Standard mounting on the panel with silicone glue (approved types see application specification).  
Optional with double-sided adhesive tape (specifications of the adhesive tape can be found in the datasheets of the manufacturer).



**Eco Junction Box – Serial Interconnection**



All mentioned versions are standard. Plus-connection see drawing.  
TÜV and UL pending.

**Junction Box with Mounted Cable and Standard Connectors**

Part Number	Contact Rails	Diodes	Rated Current (IEC 61215, Edition 2) (Ampere)	Cable Length (mm)	Wire Size (mm <sup>2</sup> )	Foil Connection
1987392-1	2	1	8	1,000	4.0	Straight
1987392-2	2	1	8	1,000	4.0	Angled

**Junction Box with Mounted Cable, Slim Line Connectors and Double-Sided Adhesive Tape**

Part Number	Contact Rails	Diodes	Rated Current (IEC 61215, Edition 2) (Ampere)	Cable Length (mm)	Wire Size (mm <sup>2</sup> )	Foil Connection
1987392-3	2	1	8	1,000	2.5	Straight

Standard mounting on the panel with silicone glue (approved types see application specification).  
Optional with double-sided adhesive tape (specifications of the adhesive tape can be found in the datasheets of the manufacturer).

**Slim Junction Box – Serial Interconnection**

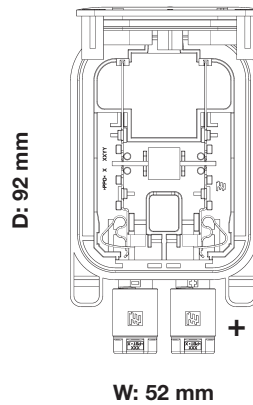

All mentioned versions are standard. Plus-connection see drawing.  
UL pending.

**Junction Box with Mounted Cable and Standard Connectors**

Part Number	Contact Rails	Diodes	Rated Current (IEC 61215, Edition 2) (Ampere)	Cable Length (mm)	Wire Size (mm <sup>2</sup> )
1971158-2	2	1	3	600	2.5

**Junction Box with Mounted Cable and Slim Line Connectors**

Part Number	Contact Rails	Diodes	Rated Current (IEC 61215, Edition 2) (Ampere)	Cable Length (mm)	Wire Size (mm <sup>2</sup> )
on request	2	1	3	600	2.5

Standard mounting on the panel with silicone glue (approved types see application specification).  
Optional with double-sided adhesive tape (specifications of the adhesive tape can be found in the datasheets of the manufacturer).

Micro Junction Box – Serial Interconnection

All mentioned versions are standard.  
Plus-connection see drawing.



TÜV pending.



**Micro Junction Box with Overmolded Cable**

Part Number	Contact Rails	Diodes	Rated Current (IEC 61215, Edition 2) (Ampere)	Cable Length (mm)	Wire Size (AWG)
1954875-3	2	1	10	750	12

Standard mounting on the panel with silicone glue (approved types see application specification).  
Optional with double-sided adhesive tape (specifications of the adhesive tape can be found in the datasheets of the manufacturer).

Junction Boxes for Building integrated PV Applications (BiPV)

**Attention:**  
It is not permitted to use  
this product and products  
including it in the USA.  
TÜV pending.



**Wing-Edge Junction Box**

Part Number	Diodes	Rated Current (IEC 61215, Edition 2) (Ampere)	Connection Type
1987293-3	1	10	with Slim Line Connector System (see Page 15)

Junction Boxes for Building integrated PV Applications (BiPV) (continued)

Connection of foil by soldering.  
Required potting material  
please see application  
specification.

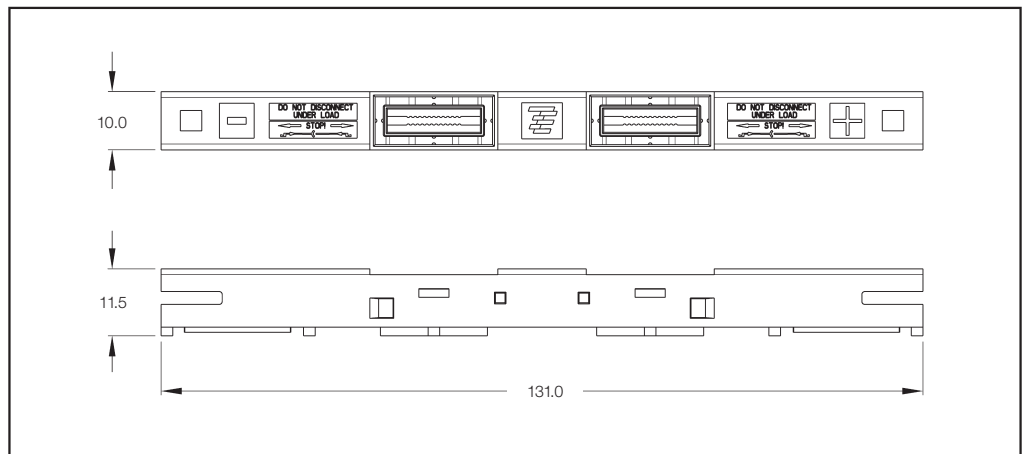

**Straddle Edge Junction Box**

Part Number	Diodes	Rated Current (IEC 61215, Edition 2) (Ampere)	Connection Type
1971569-1	1	11	Specific Connector System (see table below)

**Accessories**

Part Number	Description
1971131-1	Female Cable Coupler, Plus Contact
1971131-2	Female Cable Coupler, Minus Contact
1971133-1	Termination Connector

These specific Slim Connectors can be equipped with contacts of the SOLARLOK system on page 28.

Solar Labels

Product Features

- UV resistant
- Meet IEC61215 Edition 2.0, IEC61646 Edition 2.0
- UL- certified
- Withstand harsh outdoor environments
- Labels can be customized to customer requirements (design, logos, colors, specifications, etc.)



Product Description	Part Number	Label Description	Quantity on Roll
SOL-SD-104076-4-0.1	CN4616-000	Solar Disconnect	100
SOL-DCD-104100-4-0.1	CN4619-000	DC Disconnect	100
SOL-DPS-104019-4-0.1	CN4618-000	Warning – Dual Power Sources	100
SOL-ESH-104019-4-0.1	CN4617-000	Warning – Electric Shock Hazard	100
SOL-SD-104076-4-0.5	CL3803-000	Solar Disconnect	500
SOL-DCD-104100-4-0.5	CL3806-000	DC Disconnect	500
SOL-DPS-104019-4-0.5	CL3804-000	Warning – Dual Power Sources	500
SOL-ESH-104019-4-0.5	CL3805-000	Warning – Electric Shock Hazard	500

---

**Combiner Box**

---

**Product Features**

---

- Combines up to 5 PV strings
- Converts to standard wires
- Completely pre-assembled
- Plug and play design provides labor savings and minimizes installer error during installation
- Uses existing products currently produced by Tyco Electronics
- UL 1741 pending
- No approval for use outside Americas!
- Part No. 1954283-1



SOLARLOK Combiner Box Assembly is used to combine up to five strings in a pre-terminated connectorized weather-resistant enclosure to meet National Electric Code (NEC) requirements for series fusing of photovoltaic (PV) modules (solar panels).

The combiner box assembly consists of a box, cover (with hinges), transparent dead front lid (under the cover), and 10 pre-terminated SOLARLOK connectors each with a removeable seal cover. The box features 4 knockouts (for output wiring), lock tab, mounting slots, and pre-wired grounding clip.

The interior of the box holds 5 fuse blocks pre-wired to the positive SOLARLOK connectors, 5 terminal blocks pre-wired to the negative SOLARLOK connectors, and an equipment terminal block used to ground the equipment. Fuses are not included.

Part No. **1954283-1**

Cable Coupler – Standard Line



**Female Cable Coupler (Kit with Screw-Machined Contact)**

Part Number	Wire Size (mm <sup>2</sup> )	Keying	Package Quantity
1394462-1	2.5	Plus	100
1394462-3	4.0	Plus	100
5-1394462-5	6.0	Plus	100
1394462-2	2.5	Minus	100
1394462-4	4.0	Minus	100
5-1394462-6	6.0	Minus	100



**Male Cable Coupler (Kit with Screw-Machined Contact)**

Part Number	Wire Size (mm <sup>2</sup> )	Keying	Package Quantity
1394461-1	2.5	Plus	100
1394461-3	4.0	Plus	100
6-1394461-5	6.0	Plus	100
1394461-2	2.5	Minus	100
1394461-4	4.0	Minus	100
6-1394461-6	6.0	Minus	100
6-1394461-1	2.5	Neutral	100
6-1394461-2	4.0	Neutral	100
6-1394461-4	6.0	Neutral	100



**Female Cable Coupler (without Contact - only Housing and Sealing)**

Part Number	Wire Size (mm <sup>2</sup> )	Keying	Package Quantity
1740940-3	-	Plus	2,500
1740940-4	-	Minus	2,500



**Male Cable Coupler (without Contact - only Housing and Sealing)**

Part Number	Wire Size (mm <sup>2</sup> )	Keying	Package Quantity
1740939-5	-	Plus	2,500
1740939-4	-	Minus	2,500
1740939-2	-	Neutral	2,500





Cable Coupler – Slim Line



**Female Cable Coupler (Kit with Screw-Machined Contact)**

Part Number	Wire Size (mm <sup>2</sup> )	Keying	Package Quantity
1987559-1	2.5	Plus	100
1-1987559-1	4.0	Plus	100
1987559-2	2.5	Minus	100
1-1987559-2	4.0	Minus	100



**Male Cable Coupler (Kit with Screw-Machined Contact)**

Part Number	Wire Size (mm <sup>2</sup> )	Keying	Package Quantity
1987558-1	2.5	Plus	100
1-1987558-1	4.0	Plus	100
1987558-2	2.5	Minus	100
1-1987558-2	4.0	Minus	100
1987558-3	2.5	Neutral	100
1-1987558-3	4.0	Neutral	100



**Female Cable Coupler (without Contact – only Housing and Sealing)**

Part Number	Wire Size (mm <sup>2</sup> )	Keying	Package Quantity
1987287-1	–	Plus	2,500
1987287-2	–	Minus	2,500



**Male Cable Coupler (without Contact – only Housing and Sealing)**

Part Number	Wire Size (mm <sup>2</sup> )	Keying	Package Quantity
1987286-4	–	Plus	2,500
1987286-5	–	Minus	2,500
1987286-6	–	Neutral	2,500

TÜV and UL pending.

T-Branch Connector



**Parallel Interconnection using T-Branch Connector (Male-to-Male)**

Part Number	Keying	Package Quantity
1534611-1	Plus	20
1534611-2	Minus	20



**Parallel Interconnection using T-Branch Connector (Female-to-Male)**

Part Number	Keying	Package Quantity
1740277-1	Plus	20
1740277-2	Minus	20



Standard



NEC/UL certified

**Safety + Clip (Optional Connector Latch Locking Clip Standard)**

Part Number	Keying	Package Quantity
1534226-1	Standard	100
2106207-1	NEC/UL certified	100

**Connector Dust Covers**

Part Number	Remarks	Package Quantity
1987423-1	for Female Cable Coupler	100
1394739-1	for Male Cable Coupler	100



DC Converter Receptacle



**With O-Ring and Metal Nut (Kit with Screw-Machined Contact)**

Part Number	Wire Size (mm <sup>2</sup> )	Keying	Package Quantity
1394738-1	2.5	Plus	100
1394738-3	4.0	Plus	100
1394738-9	6.0	Plus	100
1394738-2	2.5	Minus	100
1394738-4	4.0	Minus	100
1-1394738-0	6.0	Minus	100



**With Flat Seal and Plastic Nut (Kit with Screw-Machined Contact)**

Part Number	Wire Size (mm <sup>2</sup> )	Keying	Flat Seal Color	Package Quantity
1740210-1	2.5	Plus	Black	100
1740210-3	4.0	Plus	Black	100
1740210-5	6.0	Plus	Black	100
1740210-2	2.5	Minus	Black	100
1740210-4	4.0	Minus	Black	100
1740210-6	6.0	Minus	Black	100
1740210-7	2.5	Plus	Red	100
1740210-9	4.0	Plus	Red	100
1-1740210-1	6.0	Plus	Red	100
1740210-8	2.5	Minus	Blue	100
1-1740210-0	4.0	Minus	Blue	100
1-1740210-2	6.0	Minus	Blue	100



AC Inverter Connector

Product Facts

- **Current Rating:**  
25 A per Pole
- **Voltage Rating:**  
400 V
- **Protection Degree:**  
IP67 (mated)
- **No. of Positions:**  
5 Poles
- **Temperature Range:**  
-40 °C up to +50 °C
- **Wire Size Range:**  
2.5–6.0 mm<sup>2</sup>
- **Approvals:**
  - VDE certified



Panel Mount Plug

Part Number	Nut	Cable Length (5 x 4.0 mm <sup>2</sup> )	Package Quantity
1740483-1	Metal	200 mm	24
1740483-2	Plastic	200 mm	24



Free Hanging Receptacle

Part Number	Nut	Cable Length (5 x 4.0 mm <sup>2</sup> )	Package Quantity
1740479-1	–	–	24



Complete Sets

Part Number	Nut	Cable Length (5 x 4.0 mm <sup>2</sup> )	Package Quantity
1740493-1	Metal	200 mm	24
1740493-2	Plastic	200 mm	24

Field Wiring, Switching and Protection

**Product Features**

- Modular product concept
- One- /two-pole switches
- Current up to 60 A DC
- Voltage up to 1,000 V DC
- Compact, standardized design
- Proven quality
- TÜV and UL pending

**Switching**



- One- /two-pole switch
- Main switch function
- Lockable
- Current up to 60 A DC
- Voltage up to 1,000 V DC

**Collecting**



- 2 to 6 strings input
- Cable cross section up to 6 mm<sup>2</sup>
- SOLARLOK connectors
- Current up to 60 A DC
- Voltage up to 1,000 V DC

**Protecting**



- Lightning protection



**Your Solution**



The photovoltaic integrator looks for best fit solutions to wire various types and sizes of solar generators.

The new product concept from Tyco Electronics provides this flexibility to photovoltaic integrators.

The modular product can be comprised of a switch, lightning protection, fuses or any combination of these or other commonly available components.

We can customize a product to fit your specific application. Please contact us with your requirements.

Solar Cable – TÜV and UL certified

**Product Facts**

- Dual wall insulation
- Electron beam cross-linked
- Excellent resistance to UV, water, ozone, fluids, salt, general weathering
- Excellent resistance to abrasion
- Halogen free, flame retardant, low toxicity
- Very low smoke emissions
- Excellent flexibility and stripping performance
- Wire size from 2.5 mm<sup>2</sup> up to 6.0 mm<sup>2</sup>
- Safety Class II
  - TÜV approved (2Pfg1169/08.2007)
  - UL approved (Subject 4703)



As part of expanding the SOLARLOK Product Line, Tyco Electronics has specified a wire that is designed to meet the harsh environmental conditions typical in the wiring of photovoltaic installations.

The flexible, dual wall, halogen free and cross linked solar wire offers long term stability and TÜV approval.

Its outstanding features include: high resistance against environmental conditions like humidity, UV-radiation and ozone.

In addition, it has excellent resistance to abrasion and temperature extremes.

The wire has a high dielectric withstand voltage and with its fine-stranded, tin plated copper conductor, it is easy to handle and to strip.

**Standards**

**Approval:**

- IEC 60228 Class 5 (stranded tin plated copper and flexible);
- TÜV certified according to 2Pfg1169/08.2007
- UL certified acc. Subject 4703



**Material and Finish**

**Conductor:**

Stranded tin plated copper

**Insulation:**

Electron beam cross-linked Polyolefin

**Sheath:**

Electron beam cross-linked halogen free Polyolefin

**Color:**

Black, Blue, Red

**Mechanical Features**

(according TÜV requirements)

**Max. Conductor Temperature**

**Continuous:** +125 °C  
**At Short Circuit:** +200 °C/5 s

**Min. Operating Temperature**

**Free Installation:** -40 °C  
**Fixed Installation:** -60 °C

**Wire Size Range:**

2.5 mm<sup>2</sup> (AWG 14),  
4.0 mm<sup>2</sup> (AWG 12),  
6.0 mm<sup>2</sup> (AWG 10)

**Min. Bending Radius:**

5 x cable wire diameter,  
fixed installation

**Electrical Features**

**Voltage Rating:**

600/1,000 V AC / 1,800 V DC

**Test Voltage for 5 Minutes:**

6 kV

**Max. Current Carrying Capacity (Free in Air):**

2.5 mm<sup>2</sup> – 41 A  
4.0 mm<sup>2</sup> – 55 A  
6.0 mm<sup>2</sup> – 70 A

**Additional, internal tests have been carried out.**

**Solar Cable, 1-Pole**
**Solar Cable, 1-Pole**

- TÜV approved  
(2Pfg1169/08.2007)
- UL approved  
(Subject 4703)

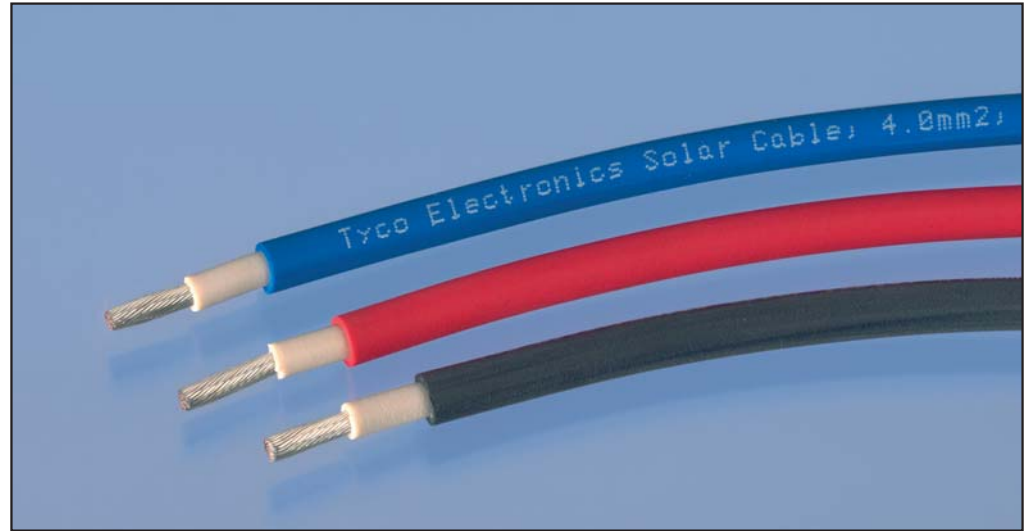
**TÜV Approved (ZKLA)**

Part Number	Cable Cross Section		Outer Diameter		Color	Package Quantity (m)
	(mm <sup>2</sup> )	(AWG)	(mm)	± Toleranz		
956297-4	2.5	14	6.65	+0.15/-0.10	Black	500
1-956297-4	2.5	14	6.65	+0.15/-0.10	Black	100
956297-5	2.5	14	6.65	+0.15/-0.10	Red	500
1-956297-5	2.5	14	6.65	+0.15/-0.10	Red	100
956297-6	2.5	14	6.65	+0.15/-0.10	Blue	500
1-956297-6	2.5	14	6.65	+0.15/-0.10	Blue	100
956298-4	4.0	12	6.90	+0.10/-0.10	Black	500
1-956298-4	4.0	12	6.90	+0.10/-0.10	Black	100
956298-5	4.0	12	6.90	+0.10/-0.10	Red	500
1-956298-5	4.0	12	6.90	+0.10/-0.10	Red	100
956298-6	4.0	12	6.90	+0.10/-0.10	Blue	500
1-956298-6	4.0	12	6.90	+0.10/-0.10	Blue	100
956299-4	6.0	10	7.35	+0.30/-0.25	Black	500
1-956299-4	6.0	10	7.35	+0.30/-0.25	Black	100
956299-5	6.0	10	7.35	+0.30/-0.25	Red	500
1-956299-5	6.0	10	7.35	+0.30/-0.25	Red	100
956299-6	6.0	10	7.35	+0.30/-0.25	Blue	500
1-956299-6	6.0	10	7.35	+0.30/-0.25	Blue	100

**UL Approved (only USE-2)**

Part Number	Cable Cross Section (AWG)	Outer Diameter (Inch)	Color	Package Quantity (Feet)
1986166-1	14	0.17	Black	7,500
1986166-2	14	0.17	Black	500
1986166-3	14	0.17	Black	2,500
1986165-1	12	0.19	Black	6,000
1986165-2	12	0.19	Black	500
1986165-3	12	0.19	Black	1,600
1986164-1	10	0.21	Black	5,500
1986164-2	10	0.21	Black	500
1986164-3	10	0.21	Black	1,000

For other Cross Sections (1.5 mm<sup>2</sup> to 400 mm<sup>2</sup>) as well as technical data please contact us.

Wiring Example with Extension Cables



Configuration Example at 4.0 mm<sup>2</sup>.

**Cable Assembly**

**Wire Size:**  
4.0 mm<sup>2</sup>

**Color:**  
Black

Cable Assembly Version	Part Numbers for Cable Length				
	1 m	3 m	5 m	10 m	20 m
<b>1</b>	1987376-1	1987376-2	1987376-3	1987376-4	1987376-5
<b>2</b>	1-1987376-1	1-1987376-2	1-1987376-3	1-1987376-4	1-1987376-5
<b>3</b>	2-1987376-1	2-1987376-2	2-1987376-3	2-1987376-4	2-1987376-5
<b>4</b>	3-1987376-1	3-1987376-2	3-1987376-3	3-1987376-4	3-1987376-5
<b>5</b>	4-1987376-1	4-1987376-2	4-1987376-3	4-1987376-4	4-1987376-5

**All used components are TÜV and UL approved.**

More variants (cable length, wire diameter, color) upon request.



Grounding Solutions

Product Features

- Self-tapping screw or nut and locking ring
- Quick and easy mounting
- Four-point contact to wire
- Low interface resistance
- Toolless termination
- Re-terminateable up to 5 times
- UV resistant
- Weather-proof
- RoHS compliant
- UL approved
- TÜV in preparation



SolKlip Grounding Clip



AWG 6-8 Grounding Connection

Description

SolKlip ground clips are designed for solar panel grounding applications using solid un-insulated copper 10 AWG and 12 AWG.

Applications

Solar panels and related products that require grounding for safety reasons.

Applications include: wire jumpers between solar panels, solar roof tiles and between panels and the AC/DC inverters.

Electrical

The electrical performance of this product will meet the tough requirements of photovoltaic grounding applications.

Product Offering & Dimensions

SolKlip for Solar Grounding (Part No. **1954381-x**) to handle solid, un-insulated ground wire from 4 mm<sup>2</sup> (AWG 12) to 6 mm<sup>2</sup> (AWG 10). For larger wires from 10 mm<sup>2</sup> (AWG 8) and 16 mm<sup>2</sup> (AWG 6) please use the AWG 6-8 Grounding Connector.

Application Tooling

No special tooling required.

Approvals

- UL 467 pending
- UL 486A-B pending
- TÜV in preparation

Materials

- Housing:** Durable PPT.
- Contact:** High conductivity copper alloy

Mechanical

The mechanical properties of this product will meet the tough requirements for grounding applications laid down in the UL requirements.

3 Easy Steps to Ground Your PV System

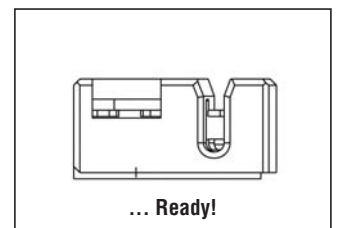
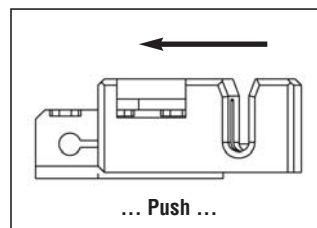

Grounding Solutions

Part Number	Description	Package Quantity
1954381-1	SolKlip with Self-Tapping Screw	100
1954381-2	SolKlip with Screw and Nut	100
1954381-3	SolKlip with Screw, Nut and Locking Ring	100
2058729-1	AWG 6-8 Grounding Clip	100

Interconnection Examples

**Serial Interconnection for Junction Boxes with Cable Glands (4.0 mm<sup>2</sup> Wiring)**

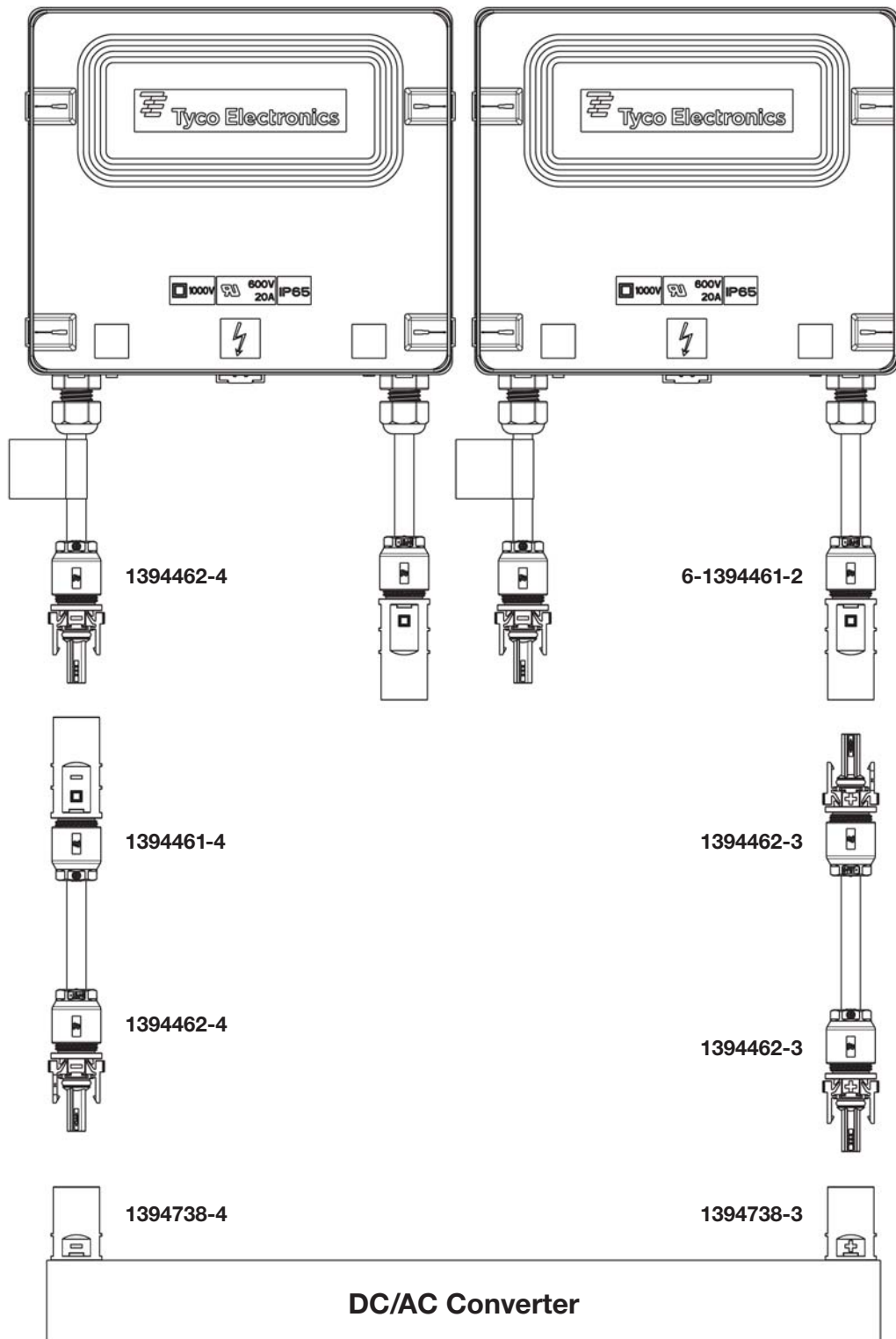

### Serial Interconnection for Junction Boxes with Plug Connectors (4.0 mm<sup>2</sup> Wiring)



Application Tooling

**Cable Assembly Tooling**



**Hand Crimping Tool for Screwed Contacts**

incl. Vario Crimp Head and Locator

Part Numbers

**1-1579004-1** (1.5 + 2.5 mm<sup>2</sup>)

**1-1579004-2** (4.0 + 6.0 mm<sup>2</sup>)

**Vario Crimp Head**

**7-1579001-8** (1.5 + 2.5 mm<sup>2</sup>)

**7-1579001-9** (4.0 + 6.0 mm<sup>2</sup>)



**Hand Crimping Tool for Stamped & Formed Contacts**

incl. Vario Crimp Head and Locator

Part No. **2063900-1**

for 2.5–6.0 mm<sup>2</sup> (AWG 10–14)

**Applicator for Strip Form Contacts**

Part No. **1855503-1**



**Extraction Tool**

suitable for all wire sizes

Part No. **1102855-3**



**Insulation Stripper**

includes length stop for all wire sizes: 1.5 mm<sup>2</sup>, 2.5 mm<sup>2</sup>, 4.0 mm<sup>2</sup> and 6.0 mm<sup>2</sup>.

Suitable for Tyco Electronics Solar Cable.

Part No. **4-1579002-2**

**SOLARLOK  
Electric Terminator CS 200**

**Base Machine:**  
Part No. **539630-1**



**Electric Terminator CS 200 for Screwed Contacts**

**Adapter for Vario Crimp Head:**  
Part No. **1579000-4**

**Vario Crimp Head (1.5 and 2.5 mm<sup>2</sup>):**

Part No. **7-1579001-8**

**Vario Crimp Head (4.0 and 6.0 mm<sup>2</sup>):**

Part No. **7-1579001-9**

**Vario Crimp Head (AWG 10):**

Part No. **8-1579001-2**

**Vario Crimp Head (AWG 12):**

Part No. **5-1579001-5**

Application Tooling (continued)

**Junction Box  
Assembly Tooling**



**Wire Spring Clamp Tool**

Part No. **1579007-2**



**Dioden/Jumper  
Spring Clamp Tool**

Part No. **1579007-5**



**Foil Spring Clamp Tool**

Part No. **1740969-3** 5-Rail Box  
Part No. **1740969-1** Medium Box  
Part No. **1740969-2** Small Box

**Field Service Kit**

Part No. **1534858-1**  
(Metric Wire)



**Kit includes the following parts:**

- 100 Cable Coupler (Housings, Plus and Minus coded)
- Crimp Contacts (4.0 and 6.0 mm<sup>2</sup>)
- Strain Relief
- Seals
- **Hand Crimp Tool:**  
Part No. **1-1579004-2**
- **Extraction Tool:**  
Part No. **1102855-3**
- **Insulation Stripper:**  
Part No. **4-1579002-2**

Contacts



**Female Contacts (Screw-Machined)**

**Material:** Copper alloy, silver plated

Wire Size		Part Number	Package Quantity
(mm <sup>2</sup> )	(AWG)		
2.5	–	1987281-1	100
4.0	–	1987281-2	100
6.0	AWG 10	1987281-3	100
–	AWG 14	1987281-4	100
–	AWG 12	1987281-5	100



**Male Contacts (Screw-Machined)**

**Material:** Copper alloy, silver plated

Wire Size		Part Number	Package Quantity
(mm <sup>2</sup> )	(AWG)		
2.5	–	1987280-1	100
4.0	–	1987280-2	100
6.0	AWG 10	1987280-3	100
–	AWG 14	1987280-4	100
–	AWG 12	1987280-5	100



**Female Contacts (Stamped and Formed)**

**Material:** Copper alloy, silver plated

Wire Size		Part Number	Package Quantity
(mm <sup>2</sup> )	(AWG)		
2.5-4.0	12-14	2058454-3	100 (Loose-Piece)
		2058454-2	6,000 (Strip Form)*

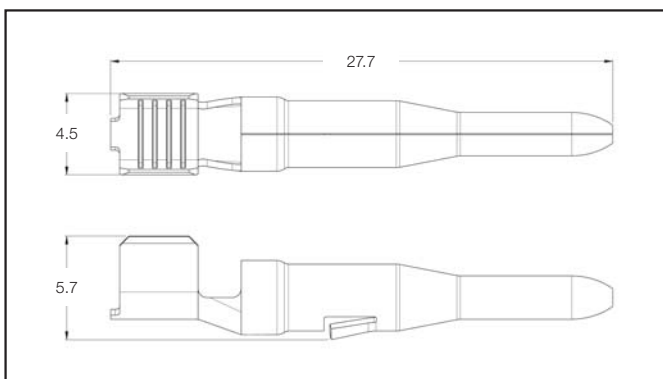

**Male Contacts (Stamped and Formed)**

**Material:** Copper alloy, silver plated

Wire Size		Part Number	Package Quantity
(mm <sup>2</sup> )	(AWG)		
2.5-4.0	12-14	2058453-3	100 (Loose-Piece)
		2058453-2	6,000 (Strip Form)*

**\*) Note:** Strip Form is only suitable for processing with Applicator, Part No. **1855503-1**.

## Assembly and Installation Guidelines

Table of Contents	Page
<b>SOLARLOK Plug Connectors</b> .....	29
1. General Comments .....	29
2. Termination of the Cable Wires / Crimping of the Contacts .....	29
3. Handling of the Connectors .....	29
3.1 Selection of Sealing Grommet for Cable Connectors .....	29
3.2 Connector Latching .....	31
3.3 Disconnecting .....	31
4. <b>Application Examples</b> .....	32
5. <b>Storage</b> .....	32
6. <b>Tooling</b> .....	32

## SOLARLOK Plug Connector

**Attention: This connector is to be used only to interconnect firmly fixed cables.**

**Do not disconnect under load.**

Current path should only be disconnected using approved disconnect devices.

Cable assemblies shall be labeled with Part No. **1394470-1**.

**To protect against shock, ensure that conductors and their associated connectors are separated from opposite polarity components.**

### IMPORTANT NOTE

**Mounting and installation must be done by qualified and trained staff considering all applying safety regulations. Tyco Electronics disclaims any warranty as a result of non-compliance to these notes.**

#### 1. General Comments

Any kind of pollution (dust, oil, humidity, etc.) during the assembly process or to the unmated connector can degrade contact and connector performance. This applies in particular to the seals and the crimping of the contacts.

A clean assembly environment is therefore essential.

#### 2. Termination of the Cable Wires and Crimping of the Contacts

SOLARLOK connectors use different crimp contacts for various wire gauges. Possible wire gauges are 2.5 mm<sup>2</sup>, 4.0 mm<sup>2</sup>, 5.3 mm<sup>2</sup> und 6.0 mm<sup>2</sup> resp. AWG 14, AWG 12 and AWG 10.

The tools to be used are selected based upon the wire gauge.

For the application specification, please refer to specification # 114-74013.

#### 3. Handling of the Connectors

##### 3.1 Selection of Sealing Grommet for Cable Connectors

Use only appropriate wire gauges.

Besides the standard seal/pinch ring combination further five different seals are available.

- 4.0 mm grommet inner diameter (for insulation diameter from 3.2 to 4.3 mm), Part No. **1394465-5**
- 5.0 mm grommet inner diameter (for insulation diameter from 4.3 to 5.3 mm), Part No. **1394465-1**
- 6.0 mm grommet inner diameter (for insulation diameter from 5.3 to 6.2 mm), Part No. **1394465-2**
- 7.0 mm grommet inner diameter (for insulation diameter from 6.2 to 7.2 mm), Part No. **1394465-3**
- 8.0 mm grommet inner diameter (for insulation diameter from 7.2 to 8.0 mm), Part No. **1394465-4**

The grommet has to be matched with the outer diameter of the solar cable (see customer drawing, Part No. **1394461** and Part No. **1394462**) and the pinch ring (Part No. **1418677-2**) must be applied.

Assembly and Installation Guidelines (continued)

When assembling the connectors, the following sequence must be followed:

- ① Stripping the Wire (please refer to application specification # 114-74013).



Fig. 1

- ② Insert the stripped wire into the wire crimp barrel until it stops. While holding the wire in place, squeeze tool handles together until ratchet releases.



Fig. 2

- ③ Push contact with cable into the connector housing (incl. seal/pinch ring combination and backshell) until you hear the contact is locked into position.



Fig. 3



- ④ Tighten backshell nut to 1.5 Nm.



Fig. 4



Assembly and Installation Guidelines (continued)

**3.2 Connector Latching**

When mating the SOLARLOK connectors, ensure the following:

- Connectors labeled with a plus or minus are keyed and can only be mated to similarly marked and keyed connectors.

**CAUTION:**

The “neutral” designated pin connectors incorporate no keying features and must only be used for Serial Interconnection of Photovoltaic Modules. The neutral product should not be used where maintaining polarity is critical.

The polarity of the “neutral” connector must be labeled with Part No. **1394725-1** or Part No. **1394725-2** nearby the connector.

- The connector system is fully latched only when the latches are flush with the mating connector.
- After the connector is fully latched, the optional latch locking clip may be snapped into place.



**Fig. 5**  
(Female Connector)

**3.3 Disconnecting**

**CAUTION: This connector must not be disconnected under load.**

Disconnect circuit from load before unplugging connectors.

Cable assemblies should be labeled using Tyco Electronics Label, Part No. **1394470-1**.

**Unmating of the connector**

**CAUTION: Do not disconnect the connector under load!**



**Fig. 6**

- ① The locking mechanism is opened by depressing the latches.
- ② Pull out the connectors. While depressing the latches, disconnect the connector by pulling the connector halves apart.

4. Application Examples



Abb. 7: Serial (Wire Diagram)



Abb. 8: Parallel (Wire Diagram)

5. Storage

See Product Specification 108-18701

6. Tooling

- Find available tools for the contact crimping on page 26 (please specify required wire gauge).
- An extraction tool (Part No. **1102855-3**) is needed to disassemble the connector components. This tool is used to unlock the contact retention features, after which the contact can be removed and re-used if necessary.

Technical Description



Fig. 9

**Technical Data (Junction Box and One Pole Plug Connectors)**
**Materials**

Socket and Pin Contacts:	CuZn
Housing:	PPO, weatherproof against UV radiation and ozone

**Color**

Connector, Junction Box:	Black
--------------------------	-------

**Electrical Features**

Withstanding Voltage:	1000 V DC
Current Rating:	up to 25 A
Contact Resistance:	$\leq 5 \text{ m}\Omega$
Contact Resistance (typical):	1 m $\Omega$
Protection Class:	II

**Mechanical Features**
**Junction Boxes**

Dimensions:	Depending on junction box type
Temperature Range:	-40 °C to +105 °C
Wire Size Range:	up to AWG 12
Protection Degree:	IP 65, closed

**Connector**

Dimensions:	Diameter 18 mm, (diameter 0.71 inch)
Temperature Range:	-40 °C to +105 °C
Wire Size Range:	AWG 14, AWG 12, AWG 10 stranded wire
Protection Degree:	IP 67, mated
Contact Finish:	silver plated,
Mating Cycles:	50, silver plated
Unmating Force:	30–40 Newton
Additional Features:	Coded housing ensures mating safety Contact voltage-proof Connector with crimp technology

<b>Standards</b>	IEC 61215 Edition 2, 61646, IEC 61730, Protection Class II, UL 1703
------------------	--

**Subject to Change.**

## Numerical Index

Part Number	Page	Part Number	Page	Part Number	Page
539630-1	26	6-1394723-5	2	1740483-1	18
956297-4	21	6-1394723-6	2	1740483-2	18
956297-5	21	1394725-1	31	1740493-1	18
956297-6	21	1394725-2	31	1740493-2	18
1-956297-4	21	1394738-1	17	1740657-8	5
1-956297-5	21	1394738-2	17	1740658-1	5
1-956297-6	21	1394738-3	17, 24,	1740699-6	4
956298-4	21		25	3-1740699-8	5
956298-5	21	1394738-4	17, 24,	3-1740699-9	5
956298-6	21		25	1740700-1	4
1-956298-4	21	1394738-9	17	1740939-2	14
1-956298-5	21	1-1394738-0	17	1740939-4	14
1-956298-6	21	1394739-1	16	1740939-5	14
956299-4	21	1418677-2	29	1740940-3	14
956299-5	21	1418867-6	6	1740940-4	14
956299-6	21	1534226-1	16	1740969-1	27
1-956299-4	21	1534611-1	16	1740969-2	27
1-956299-5	21	1534611-2	16	1740969-3	27
1-956299-6	21	1534858-1	27	1740971-2	4
1102855-3	26, 27,	1579000-4	26	1740972-1	4
	32	5-1579001-5	26	1855503-1	26, 28
1394461-1	14	7-1579001-8	26	1954283-1	13
1394461-2	14	7-1579001-9	26	1954381-1	23
1394461-3	14, 22	8-1579001-2	26	1954381-2	23
1394461-4	14, 22,	4-1579002-2	26, 27	1954381-3	23
	24	1-1579004-1	26	1954875-3	9
6-1394461-1	14	1-1579004-2	26, 27	1971131-1	11
6-1394461-2	14, 24	1579007-2	27	1971131-2	11
6-1394461-4	14	1579007-5	27	1971133-1	11
6-1394461-5	14	1740077-1	2	1971158-2	8
6-1394461-6	14	1740077-3	2	1971569-1	11
1394462-1	14	1740210-1	17	1981987-1	2
1394462-2	14	1740210-2	17	1981988-1	2
1394462-3	14, 22,	1740210-3	17	1986164-1	21
	24, 25	1740210-4	17	1986164-2	21
1394462-4	14, 22,	1740210-5	17	1986164-3	21
	24, 25	1740210-6	17	1986165-1	21
5-1394462-5	14	1740210-7	17	1986165-2	21
5-1394462-6	14	1740210-8	17	1986165-3	21
1394465-1	29	1740210-9	17	1986166-1	21
1394465-2	29	1-1740210-0	17	1986166-2	21
1394465-3	29	1-1740210-1	17	1986166-3	21
1394465-4	29	1-1740210-2	17	1987002-4	4
1394465-5	29	1740277-1	16	1987003-3	4
1394470-1	29, 31	1740277-2	16	1987225-6	6
2-1394723-4	2	1740300-2	2	1987252-1	6
3-1394723-0	2	1740425-5	6	1987254-2	2
5-1394723-3	2	1740479-1	18	1987280-1	28

## Numerical Index

Part Number	Page	Part Number	Page	Part Number	Page
1987280-2	28	1-1987376-3	22	1987558-1	15
1987280-3	28	1-1987376-4	22	1987558-2	15
1987280-4	28	1-1987376-5	22	1987558-3	15
1987280-5	28	2-1987376-1	22	1-1987558-1	15
1987281-1	28	2-1987376-2	22	1-1987558-2	15
1987281-2	28	2-1987376-3	22	1-1987558-3	15
1987281-3	28	2-1987376-4	22	1987559-1	15
1987281-4	28	2-1987376-5	22	1987559-2	15
1987281-5	28	3-1987376-1	22	1-1987559-1	15
1987286-4	15	3-1987376-2	22	1-1987559-2	15
1987286-5	15	3-1987376-3	22	1987777-1	6
1987286-6	15	3-1987376-4	22	1987858-3	3
1987287-1	15	3-1987376-5	22	1987982-3	3
1987287-2	15	4-1987376-1	22	1987994-1	5
1987293-3	10	4-1987376-2	22	1987995-1	5
1987294-2	2	4-1987376-3	22	2058453-2	28
1987376-1	22	4-1987376-4	22	2058453-3	28
1987376-2	22	4-1987376-5	22	2058454-2	28
1987376-3	22	1987392-1	7	2058454-3	28
1987376-4	22	1987392-2	7	2058729-1	23
1987376-5	22	1987392-3	7	2063900-1	26
1-1987376-1	22	1987423-1	16	2106207-1	16
1-1987376-2	22	1987459-1	6		

**Disclaimer**

While Tyco Electronics and its affiliates referenced herein have made every reasonable effort to ensure the accuracy of the information contained in this catalog, Tyco Electronics cannot assure that this information is error free. For this reason, Tyco Electronics does not make any representation or offer any guarantee that such information is accurate, correct, reliable or current. Tyco Electronics reserves the right to make any adjustments to the information at any time. Tyco Electronics expressly disclaims any implied warranty regarding the information contained herein, including, but not limited to, the implied warranties of merchantability or fitness for a particular purpose. Tyco Electronics' only obligations are those stated in Tyco Electronics' Standard Terms and Conditions of Sale. Tyco Electronics will in no case be liable for any incidental, indirect or consequential damages arising from or in connection with, including, but not limited to, the sale, resale, use or misuse of its products. Users should rely on their own judgment to evaluate the suitability of a product for a certain purpose and test each product for its intended application.

In case of any potential ambiguities or questions, please don't hesitate to contact us for clarification.

[www.tycoelectronics.com](http://www.tycoelectronics.com)

SOLARLOK, SOLKLIP, TE Logo and Tyco Electronics are trademarks.

---

## Restriction on the Use of Hazardous Substances (RoHS)

---

### Restriction on the Use of Hazardous Substances (RoHS)

At Tyco Electronics, we're ready to support your RoHS requirements. We've assessed more than 1.5 million end items/components for RoHS compliance, and issued new part numbers where any change was required to eliminate the restricted materials. Part numbers in this catalog are identified as:

#### RoHS Compliant

Part numbers in this catalog are RoHS Compliant, unless marked otherwise.

These products comply with European Union Directive 2002/95/EC as amended 1 January 2006 that restricts the use of lead, mercury, cadmium, hexavalent chromium, PBB, and PBDE in certain electrical and electronic products sold into the EU as of 1 July 2006.

**Note:** For purposes of this Catalog, included within the definition of RoHS Compliant are products that are clearly "Out of Scope" of the RoHS Directive such as hand tools and other non-electrical accessories.

#### Non-RoHS Compliant

These part numbers are identified with a "◆" symbol. These products do not comply with the material restrictions of the European Union Directive 2002/95/EC.

#### 5 of 6 Compliant

A "●" symbol identifies these part numbers. These products do not fully comply with the European Union Directive 2002/95/EC because they contain lead in solderable interfaces (they do not contain any of the other five restricted substances above allowable limits). However, these products may be suitable for use in RoHS applications where there is an application-based exception for lead in solders, such as the server, storage, or networking infrastructure exemption.

**Note:** Information regarding RoHS compliance is provided based on reasonable inquiry of our suppliers and represents our current actual knowledge based on the information provided by our suppliers. This information is subject to change. For latest compliance status, refer to our website referenced below.

#### Getting the Information You Need

Our comprehensive on-line RoHS Customer Support Center provides a forum to answer your questions and support your RoHS needs. A RoHS FAQ (Frequently Asked Questions) is available with links to more detailed information. You can also submit RoHS questions and receive a response within 24 hours during a normal work week. The Support Center also provides:

- Cross-Reference from Non-compliant to Compliant Products
- Ability to browse RoHS Compliant Products in our on-line catalog:  
<http://ecommas.tycoelectronics.com/commerce/alt/RohsAltHome.do>
- Downloadable Technical Data Customer Information Presentation
- More detailed information regarding the definitions used above

RoHS  
Customer  
Support  
Center 

So whatever your questions when it comes to RoHS, we've got the answers at [www.tycoelectronics.com/leadfree](http://www.tycoelectronics.com/leadfree)

## Americas

**Argentina** – Buenos Aires  
Phone: +54-11-4733-2200  
Fax: +54-11-4733-2211

**Brasil** – São Paulo  
Phone: +55-11-2103-6000  
Fax: +55-11-2103-6030

**Chile** – Santiago  
Phone: +56-2-345-0361  
Fax: +56-2-223-1477

**Canada** – Toronto  
Phone: +1-905-475-6222  
Fax: +1-905-474-5520  
**Product Information Center:**  
Phone: +1-905-470-4425  
Fax: +1-905-474-5525

**Colombia** – Bogota  
Phone: +57-1-319-8959  
Fax: +57-1-319-8960

**Mexico** – Mexico City  
Phone: +52-55-1106-0800  
+01-800-733-8926  
Fax: +52-55-1106-0901

**For Latin/South American Countries not shown**  
Phone: +54-11-4733-2015  
Fax: +54-11-4733-2083

**United States**  
Harrisburg, PA  
Phone: +1-717-564-0100  
Fax: +1-717-986-7575  
**Product Information Center:**  
Phone: +1-800-522-6752  
Fax: +1-717-986-7575

## Asia/Pacific

**Australia** – Sydney  
Phone: +61-2-9554-2600  
Fax: +61-2-9502-2556  
**Product Information Center:**  
Phone: +61-2-9840-8200  
Fax: +61-2-9634-6188

**India** – Bangalore  
Phone: +91-80-2854-0800  
Fax: +91-80-2854-0820

**Indonesia** – Jakarta  
Phone: +65-6482-0311  
Fax: +65-6482-1012

**Japan** – Kawasaki, Kanagawa  
Phone: +81-44-844-8111  
Fax: +81-44-812-3207  
**Product Information Center:**  
Phone: +81-44-844-8013  
Fax: +81-44-812-3200

**Korea** – Seoul  
Phone: +82-2-3415-4500  
Fax: +82-2-3486-3810

**Malaysia** – Selangor  
Phone: +60-3-7805-3055  
Fax: +60-3-7805-3066

**New Zealand** – Auckland  
Phone: +64-9-634-4580  
Fax: +64-9-634-4586

**Philippines** – Makati City  
Phone: +632-848-0171  
Fax: +632-867-8661

**People's Republic of China**  
Hong Kong  
Phone: +852-2735-1628  
Fax: +852-2735-0243

Shanghai  
Phone: +86-21-2407-1588  
Fax: +86-21-2407-1599

**Singapore** – Singapore  
Phone: +65-6482-0311  
Fax: +65-6482-1012

**Taiwan** – Taipei  
Phone: +886-2-8768-2788  
Fax: +886-2-8768-2268

**Thailand** – Bangkok  
Phone: +66-2-955-0500  
Fax: +66-2-955-0505

**Vietnam** – Ho Chi Minh City  
Phone: +84-8-930-5546  
Fax: +84-8-930-3443

## Europe/Middle East/Africa

**Austria** – Vienna  
Phone: +43-1-905-60-0  
Fax: +43-1-905-60-1333  
**Product Information Center:**  
Phone: +43-1-905-60-1228  
Fax: +43-1-905-60-1258

**Belarus** – Minsk  
Phone: +375-17-237-47-94  
Fax: +375-17-237-47-94

**Belgium** – Kessel-Lo  
Phone: +32-16-352-300  
Fax: +32-16-352-355

**Bulgaria** – Sofia  
Phone: +359-2-971-2152  
Fax: +359-2-971-2153

**Czech Republic and Slovakia**  
**Czech Republic** – Kurim  
Phone: +420-541-162-111  
Fax: +420-541-162-223  
**Product Information Center:**  
Phone: +420-541-162-113  
Fax: +420-541-162-132

**Denmark** – Glostrup  
Phone: +45-43-48-04-00  
Fax: +45-43-44-14-14

**Egypt** – Cairo  
Phone: +202-419-2334  
Fax: +202-417-7647

**Estonia** – Tartu  
Phone: +372-5138-274  
Fax: +372-7400-779

**Finland** – Helsinki  
Phone: +358-95-12-34-20  
Fax: +358-95-12-34-250

**France** – Cergy-Pontoise Cedex  
Phone: +33-1-3420-8888  
Fax: +33-1-3420-8600  
**Product Information Center:**  
Phone: +33-1-3420-8686  
Fax: +33-1-3420-8623

**France Export Divisions** –  
Cergy-Pontoise Cedex  
Phone: +33-1-3420-8804  
Fax: +33-1-3420-8699

**Germany** – Bensheim  
Phone: +49-6251-133-0  
Fax: +49-6251-133-1600  
**Product Information Center:**  
Phone: +49-6251-133-1999  
Fax: +49-6251-133-1988

**Greece** – Athens  
Phone: +30-210-9370-396/397  
Fax: +30-210-9370-655

**Hungary** – Budapest  
Phone: +36-1-289-1000  
Fax: +36-1-289-1010  
**Product Information Center:**  
Phone: +36-1-289-1016  
Fax: +36-1-289-1017

**Ireland** – Dublin  
Phone: +353-1-866-5612  
Fax: +353-1-866-5714

**Israel** – Petach-Tikva  
Phone: +972-3-929-0999  
Fax: +972-3-919-1088

**Italy** – Collegno (Torino)  
Phone: +39-011-4012-111  
Fax: +39-011-4031-116  
**Product Information Center:**  
Phone: +39-011-4012-428  
Fax: +39-011-40-287-428

**Lithuania and Latvia**  
**Lithuania** – Vilnius  
Phone: +370-5-213-1402  
Fax: +370-5-213-1403

**Netherlands** – 's-Hertogenbosch  
Phone: +31-73-6246-246  
Fax: +31-73-6212-365  
**Product Information Center:**  
Phone: +31-73-6246-999  
Fax: +31-73-6246-998

**Norway** – Nesbru  
Phone: +47-66-77-88-50  
Fax: +47-66-77-88-55

**Poland** – Warsaw  
Phone: +48-22-4576-700  
Fax: +48-22-4576-720  
**Product Information Center:**  
Phone: +48-22-4576-704  
Fax: +48-22-4576-720

**Romania** – Bucharest  
Phone: +40-21-311-3479/3596  
Fax: +40-21-312-0574

**Russia** – Moscow  
Phone: +7-495-790-7902  
Fax: +7-495-721-1893  
**Product Information Center:**  
Phone: +7-495-790-7902-404  
Fax: +7-495-790-7902-401

**Slovenia** – Ljubljana  
Phone: +386-1561-3270  
Fax: +386-1561-3240

**South Africa** – Port Elizabeth  
Phone: +27-41-503-4500  
Fax: +27-41-581-0440

**Spain** – Barcelona  
Phone: +34-93-291-0330  
Fax: +34-93-201-7879

**Sweden** – Upplands Väsby  
Phone: +46-8-50-72-50-00  
Fax: +46-8-50-72-50-01

**Switzerland** – Steinach  
Phone: +41-71-447-0447  
Fax: +41-71-447-0444

**Turkey** – Istanbul  
Phone: +90-212-281-8181/2/3  
+90-212-282-5130/5430  
Fax: +90-212-281-8184

**Ukraine** – Kiev  
Phone: +380-44-206-2265  
Fax: +380-44-206-2264  
**Product Information Center:**  
Phone: +380-44-206-2265  
Fax: +380-44-206-2264

**United Kingdom** – Swindon  
Phone: +44-8706-080208  
Fax: +44-208-954-6234

**Tyco Electronics AMP GmbH**

AMPèrestr. 12-14  
64625 Bensheim / Germany  
Phone: +49-(0)6251-133-0  
Fax: +49-(0)6251-133-1600

[www.tycoelectronics.com](http://www.tycoelectronics.com)  
SOLARLOK, SOLKLIP, TE Logo  
and Tyco Electronics are trademarks.

© 2009 Tyco Electronics Ltd.  
889753-3 Revised 9-2009 12M ST



## Данный компонент на территории Российской Федерации

### Вы можете приобрести в компании MosChip.

Для оперативного оформления запроса Вам необходимо перейти по данной ссылке:

<http://moschip.ru/get-element>

Вы можете разместить у нас заказ для любого Вашего проекта, будь то серийное производство или разработка единичного прибора.

В нашем ассортименте представлены ведущие мировые производители активных и пассивных электронных компонентов.

Нашей специализацией является поставка электронной компонентной базы двойного назначения, продукции таких производителей как XILINX, Intel (ex.ALTERA), Vicor, Microchip, Texas Instruments, Analog Devices, Mini-Circuits, Amphenol, Glenair.

Сотрудничество с глобальными дистрибьюторами электронных компонентов, предоставляет возможность заказывать и получать с международных складов практически любой перечень компонентов в оптимальные для Вас сроки.

На всех этапах разработки и производства наши партнеры могут получить квалифицированную поддержку опытных инженеров.

Система менеджмента качества компании отвечает требованиям в соответствии с ГОСТ Р ИСО 9001, ГОСТ РВ 0015-002 и ЭС РД 009

### Офис по работе с юридическими лицами:

105318, г.Москва, ул.Щербаковская д.3, офис 1107, 1118, ДЦ «Щербаковский»

Телефон: +7 495 668-12-70 (многоканальный)

Факс: +7 495 668-12-70 (доб.304)

E-mail: [info@moschip.ru](mailto:info@moschip.ru)

Skype отдела продаж:

moschip.ru

moschip.ru\_4

moschip.ru\_6

moschip.ru\_9