

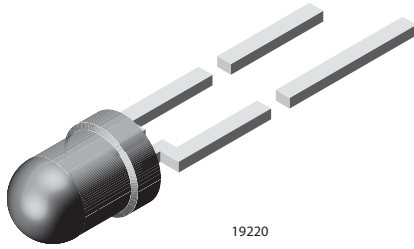

Low Current LED in Ø 3 mm Tinted Diffused Package



FEATURES

- Low power consumption
• High brightness
• CMOS/MOS compatible
• Specified at IF = 2 mA
• Luminous intensity categorized
• Yellow and green color categorized
• Material categorization:
For definitions of compliance please see
www.vishay.com/doc?99912



PRODUCT GROUP AND PACKAGE DATA

- Product group: LED
• Package: 3 mm
• Product series: low current
• Angle of half intensity: ± 25°

APPLICATIONS

- Low power DC circuits

Table with 14 columns: PART, COLOR, LUMINOUS INTENSITY (mcd) [MIN., TYP., MAX.], at IF (mA), WAVELENGTH (nm) [MIN., TYP., MAX.], at IF (mA), FORWARD VOLTAGE (V) [MIN., TYP., MAX.], at IF (mA), TECHNOLOGY. Rows include various part numbers like TLLR4400, TLLY4400, and TLLG4400 in Red, Yellow, and Green colors.

**ABSOLUTE MAXIMUM RATINGS** ( $T_{amb} = 25\text{ }^{\circ}\text{C}$ , unless otherwise specified)  
**TLLG440., TLLR440., TLLY440.**

PARAMETER	TEST CONDITION	SYMBOL	VALUE	UNIT
Reverse voltage		$V_R$	6	V
DC forward current		$I_F$	7	mA
Surge forward current	$t_p \leq 10\text{ }\mu\text{s}$	$I_{FSM}$	0.15	A
Power dissipation	$T_{amb} \leq 84\text{ }^{\circ}\text{C}$	$P_V$	20	mW
Junction temperature		$T_j$	100	$^{\circ}\text{C}$
Operating temperature range		$T_{amb}$	- 40 to + 100	$^{\circ}\text{C}$
Storage temperature range		$T_{stg}$	- 55 to + 100	$^{\circ}\text{C}$
Soldering temperature	$t \leq 5\text{ s}$ , 2 mm from body	$T_{sd}$	260	$^{\circ}\text{C}$
Thermal resistance junction/ambient		$R_{thJA}$	800	K/W

**OPTICAL AND ELECTRICAL CHARACTERISTICS** ( $T_{amb} = 25\text{ }^{\circ}\text{C}$ , unless otherwise specified)  
**TLLR440., RED**

PARAMETER	TEST CONDITION	PART	SYMBOL	MIN.	TYP.	MAX.	UNIT
Luminous intensity <sup>(1)</sup>	$I_F = 2\text{ mA}$	TLLR4400	$I_V$	0.63	1.2	-	mcd
		TLLR4401	$I_V$	1	2	-	mcd
Dominant wavelength	$I_F = 2\text{ mA}$		$\lambda_d$	612	-	625	nm
Peak wavelength	$I_F = 2\text{ mA}$		$\lambda_p$	-	635	-	nm
Angle of half intensity	$I_F = 2\text{ mA}$		$\phi$	-	$\pm 25$	-	deg
Forward voltage	$I_F = 2\text{ mA}$		$V_F$	-	1.9	2.4	V
Reverse voltage	$I_R = 10\text{ }\mu\text{A}$		$V_R$	6	20	-	V
Junction capacitance	$V_R = 0\text{ V}$ , $f = 1\text{ MHz}$		$C_j$	-	50	-	pF

**Note**<sup>(1)</sup> In one packing unit  $I_{Vmin.}/I_{Vmax.} \leq 0.5$ **OPTICAL AND ELECTRICAL CHARACTERISTICS** ( $T_{amb} = 25\text{ }^{\circ}\text{C}$ , unless otherwise specified)  
**TLLY440., YELLOW**

PARAMETER	TEST CONDITION	PART	SYMBOL	MIN.	TYP.	MAX.	UNIT
Luminous intensity <sup>(1)</sup>	$I_F = 2\text{ mA}$	TLLY4400	$I_V$	0.63	1.2	-	mcd
		TLLY4401	$I_V$	1	2	-	mcd
Dominant wavelength	$I_F = 2\text{ mA}$		$\lambda_d$	581	-	594	nm
Peak wavelength	$I_F = 2\text{ mA}$		$\lambda_p$	-	585	-	nm
Angle of half intensity	$I_F = 2\text{ mA}$		$\phi$	-	$\pm 25$	-	deg
Forward voltage	$I_F = 2\text{ mA}$		$V_F$	-	2.4	2.9	V
Reverse voltage	$I_R = 10\text{ }\mu\text{A}$		$V_R$	6	20	-	V
Junction capacitance	$V_R = 0\text{ V}$ , $f = 1\text{ MHz}$		$C_j$	-	50	-	pF

**Note**<sup>(1)</sup> In one packing unit  $I_{Vmin.}/I_{Vmax.} \leq 0.5$



OPTICAL AND ELECTRICAL CHARACTERISTICS (T <sub>amb</sub> = 25 °C, unless otherwise specified)							
TLLG440., GREEN							
PARAMETER	TEST CONDITION	PART	SYMBOL	MIN.	TYP.	MAX.	UNIT
Luminous intensity <sup>(1)</sup>	I <sub>F</sub> = 10 mA	TLLG4400	I <sub>V</sub>	0.63	1.2	-	mcd
		TLLG4401	I <sub>V</sub>	1	2	-	mcd
Dominant wavelength	I <sub>F</sub> = 10 mA		λ <sub>d</sub>	562	-	575	nm
Peak wavelength	I <sub>F</sub> = 10 mA		λ <sub>p</sub>	-	565	-	nm
Angle of half intensity	I <sub>F</sub> = 10 mA		φ	-	± 25	-	deg
Forward voltage	I <sub>F</sub> = 20 mA		V <sub>F</sub>	-	1.9	2.4	V
Reverse voltage	I <sub>R</sub> = 10 μA		V <sub>R</sub>	6	20	-	V
Junction capacitance	V <sub>R</sub> = 0 V, f = 1 MHz		C <sub>j</sub>	-	50	-	pF

Note

(1) In one packing unit I<sub>Vmin</sub>/I<sub>Vmax</sub> ≤ 0.5

LUMINOUS INTENSITY CLASSIFICATION		
GROUP	LIGHT INTENSITY (mcd)	
STANDARD	MIN.	MAX.
K	0.63	1.25
L	1	2
M	1.6	3.2
N	2.5	5
P	4	8
Q	6.3	12.5
R	10	20
S	16	32
T	25	50
U	40	80

Note

- Luminous intensity is tested at a current pulse duration of 25 ms. The above type numbers represent the order groups which include only a few brightness groups. Only one group will be shipped on each bag (there will be no mixing of two groups on each bag). In order to ensure availability, single brightness groups will not be orderable. In a similar manner for colors where wavelength groups are measured and binned, single wavelength groups will be shipped on any one bag. In order to ensure availability, single wavelength groups will not be orderable.

COLOR CLASSIFICATION				
GROUP	DOM. WAVELENGTH (nm)			
	YELLOW		GREEN	
	MIN.	MAX.	MIN.	MAX.
0	-	-	-	-
1	581	584	-	-
2	583	586	-	-
3	585	588	562	565
4	587	590	564	567
5	589	592	566	569
6	591	594	568	571
7	-	-	570	573
8	-	-	572	575

Note

- Wavelengths are tested at a current pulse duration of 25 ms.



TYPICAL CHARACTERISTICS (T<sub>amb</sub> = 25 °C, unless otherwise specified)

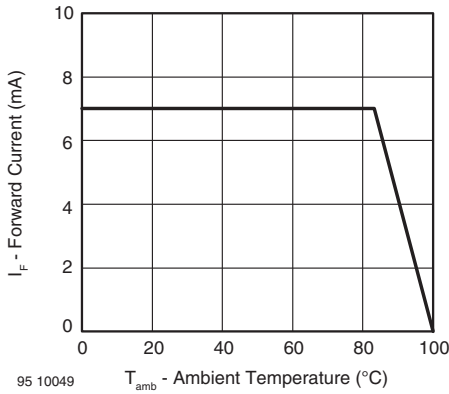

Fig. 1 - Forward Current vs. Ambient Temperature

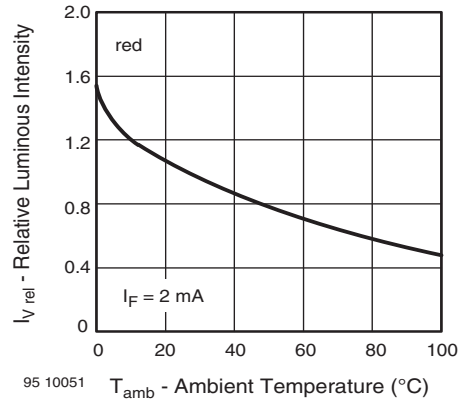

Fig. 4 - Relative Luminous Intensity vs. Ambient Temperature

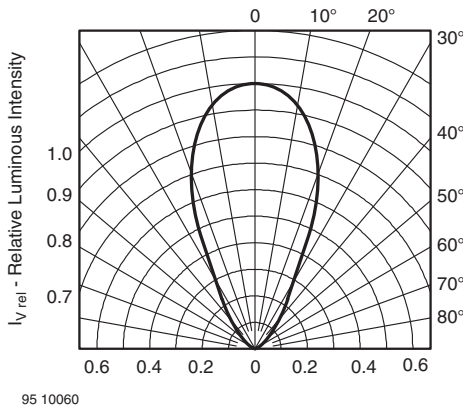

Fig. 2 - Relative Luminous Intensity vs. Angular Displacement

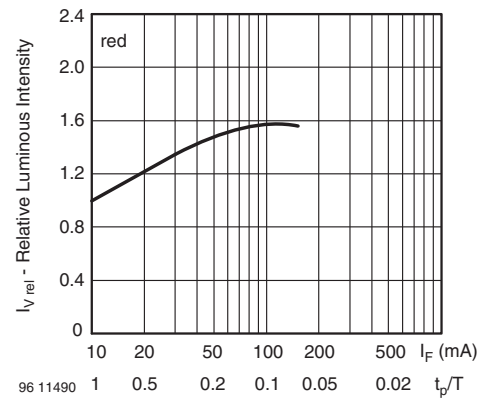

Fig. 5 - Relative Luminous Intensity vs. Forward Current/Duty Cycle

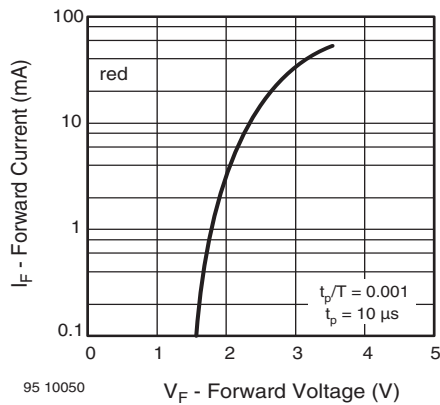

Fig. 3 - Forward Current vs. Forward Voltage

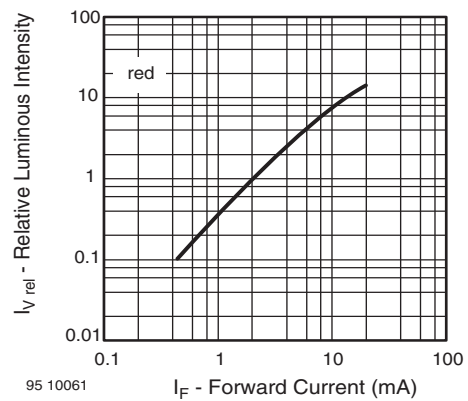

Fig. 6 - Relative Luminous Intensity vs. Forward Current

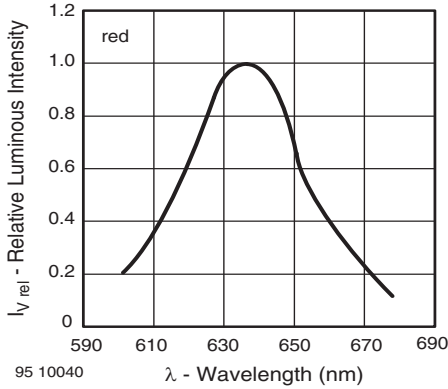

Fig. 7 - Relative Intensity vs. Wavelength

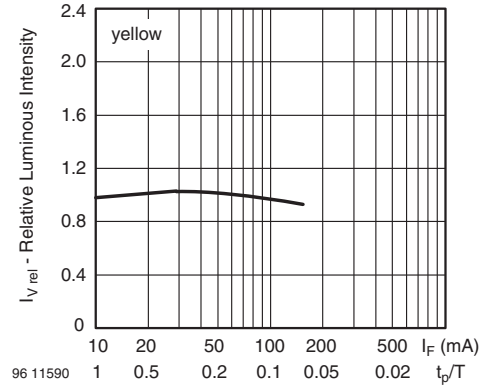

Fig. 10 - Relative Luminous Intensity vs. Forward Current/Duty Cycle

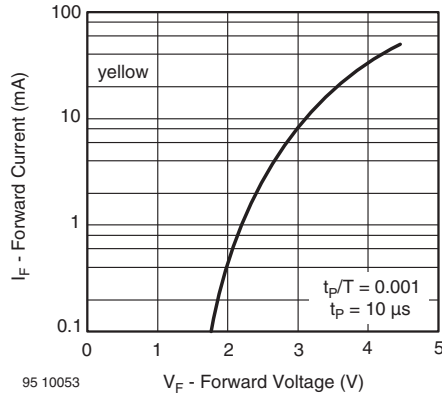

Fig. 8 - Forward Current vs. Forward Voltage

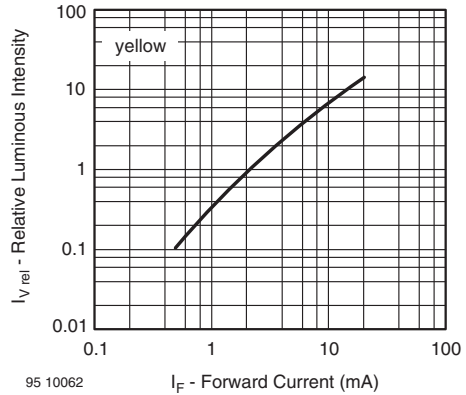

Fig. 11 - Relative Luminous Intensity vs. Forward Current

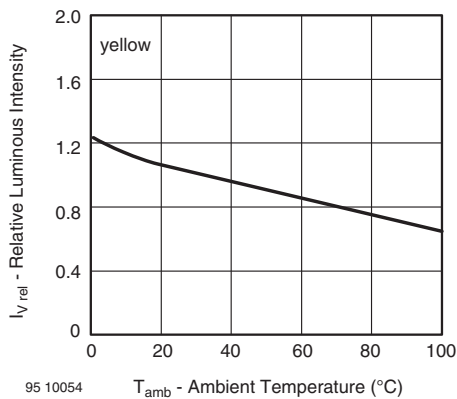

Fig. 9 - Relative Luminous Intensity vs. Ambient Temperature

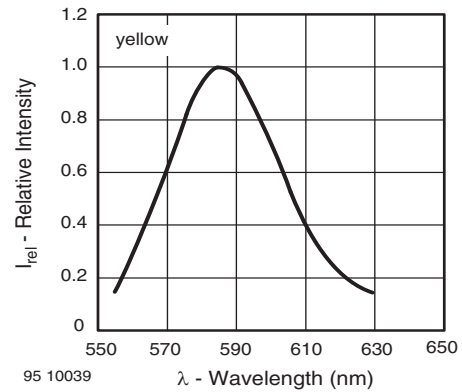

Fig. 12 - Relative Intensity vs. Wavelength



Fig. 13 - Forward Current vs. Forward Voltage



Fig. 16 - Relative Luminous Intensity vs. Forward Current

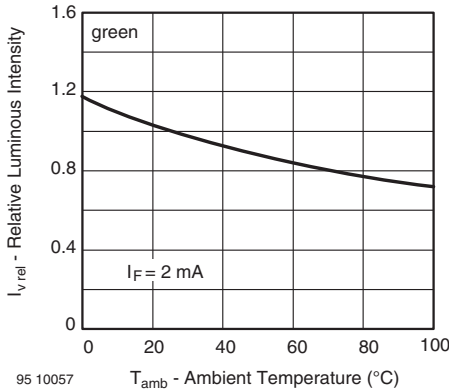

Fig. 14 - Relative Luminous Intensity vs. Ambient Temperature

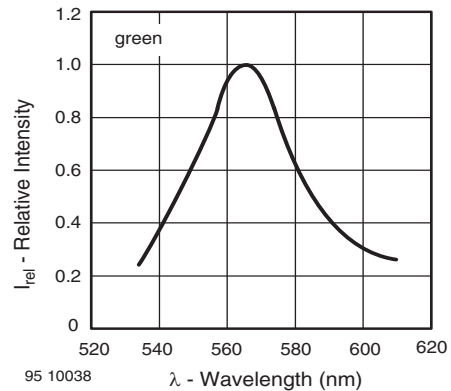

Fig. 17 - Relative Intensity vs. Wavelength



Fig. 15 - Relative Luminous Intensity vs. Forward Current/Duty Cycle



PACKAGE DIMENSIONS in millimeters

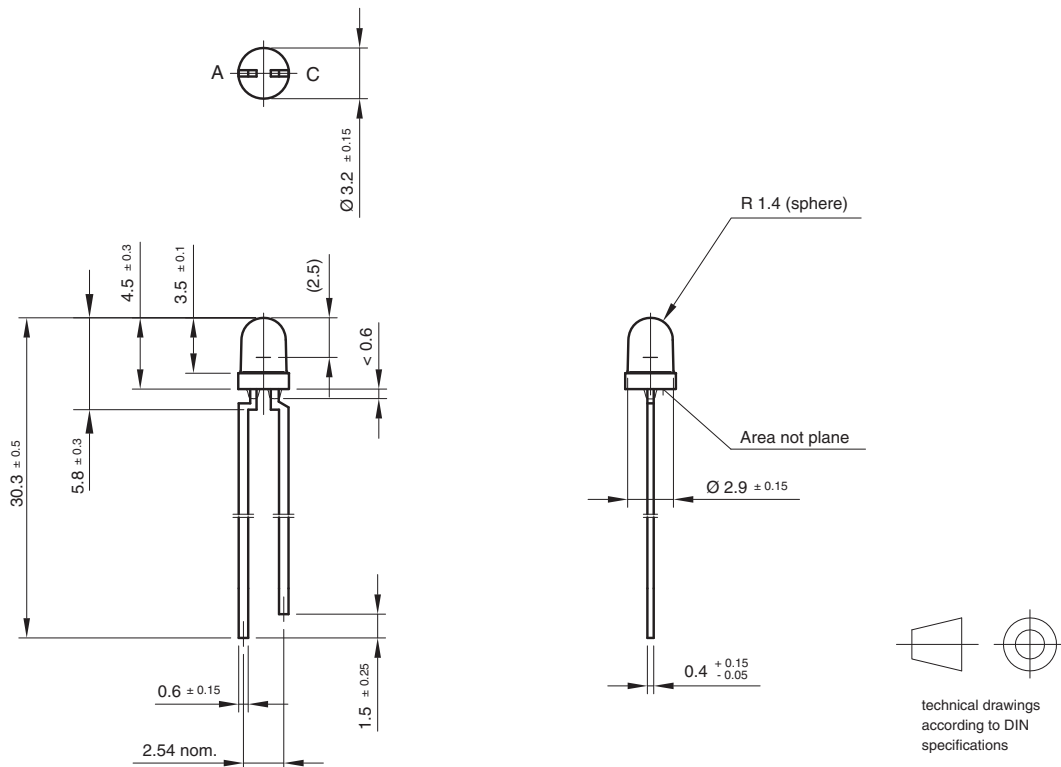

Drawing-No.: 6.544-5255.01-4  
Issue: 7; 25.09.08  
95 10913

REEL DIMENSIONS in millimeters

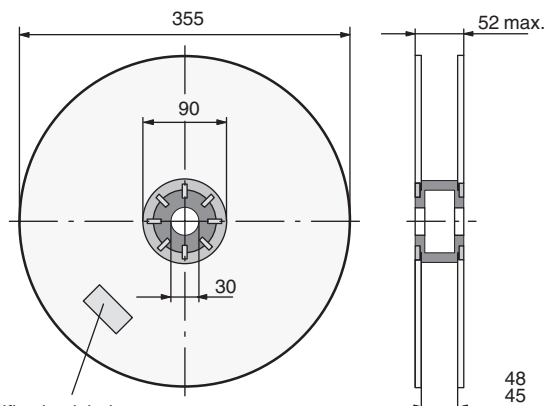

Identification label:  
Vishay/type/group/tape code/production code/quantity

948641

Fig. 18 - Reel

AS12 = cathode leaves tape first

AS21 = anode leaves tape first

TAPE

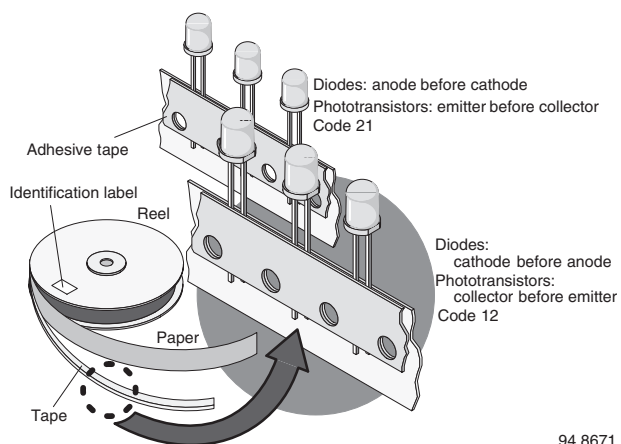
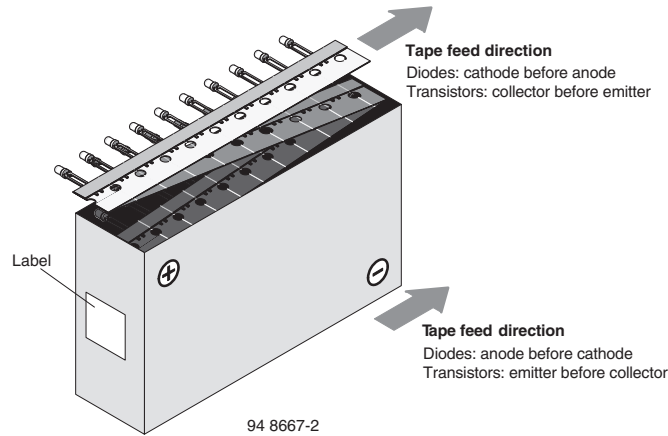

Fig. 19 - LED in Tape

94 8671

**AMMOPACK**



94 8667-2

Fig. 20 - Tape Direction

**Note**

- The new nomenclature for ammpack is ASZ only, without suffix for the LED orientation. The carton box has to be turned to the desired position: "+" for anode first, or "-" for cathode first. AS12Z and AS21Z are still valid for already existing types, BUT NOT FOR NEW DESIGN.

**TAPE DIMENSIONS** in millimeters

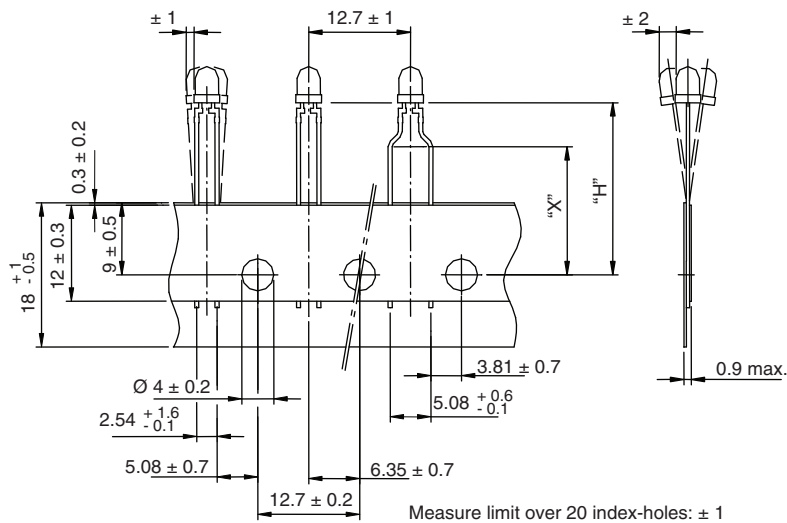

Quantity per:	Reel (Mat.-no. 1764)
	2000

21885

OPTION	DIMENSION "H" ± 0.5 mm	DIMENSION "X" ± 0.5 mm
AS	17.3	-
MS	25.5	-
BT	20.0	16.0





## Disclaimer

ALL PRODUCT, PRODUCT SPECIFICATIONS AND DATA ARE SUBJECT TO CHANGE WITHOUT NOTICE TO IMPROVE RELIABILITY, FUNCTION OR DESIGN OR OTHERWISE.

Vishay Intertechnology, Inc., its affiliates, agents, and employees, and all persons acting on its or their behalf (collectively, "Vishay"), disclaim any and all liability for any errors, inaccuracies or incompleteness contained in any datasheet or in any other disclosure relating to any product.

Vishay makes no warranty, representation or guarantee regarding the suitability of the products for any particular purpose or the continuing production of any product. To the maximum extent permitted by applicable law, Vishay disclaims (i) any and all liability arising out of the application or use of any product, (ii) any and all liability, including without limitation special, consequential or incidental damages, and (iii) any and all implied warranties, including warranties of fitness for particular purpose, non-infringement and merchantability.

Statements regarding the suitability of products for certain types of applications are based on Vishay's knowledge of typical requirements that are often placed on Vishay products in generic applications. Such statements are not binding statements about the suitability of products for a particular application. It is the customer's responsibility to validate that a particular product with the properties described in the product specification is suitable for use in a particular application. Parameters provided in datasheets and/or specifications may vary in different applications and performance may vary over time. All operating parameters, including typical parameters, must be validated for each customer application by the customer's technical experts. Product specifications do not expand or otherwise modify Vishay's terms and conditions of purchase, including but not limited to the warranty expressed therein.

Except as expressly indicated in writing, Vishay products are not designed for use in medical, life-saving, or life-sustaining applications or for any other application in which the failure of the Vishay product could result in personal injury or death. Customers using or selling Vishay products not expressly indicated for use in such applications do so at their own risk. Please contact authorized Vishay personnel to obtain written terms and conditions regarding products designed for such applications.

No license, express or implied, by estoppel or otherwise, to any intellectual property rights is granted by this document or by any conduct of Vishay. Product names and markings noted herein may be trademarks of their respective owners.

## Material Category Policy

**Vishay Intertechnology, Inc. hereby certifies that all its products that are identified as RoHS-Compliant fulfill the definitions and restrictions defined under Directive 2011/65/EU of The European Parliament and of the Council of June 8, 2011 on the restriction of the use of certain hazardous substances in electrical and electronic equipment (EEE) - recast, unless otherwise specified as non-compliant.**

**Please note that some Vishay documentation may still make reference to RoHS Directive 2002/95/EC. We confirm that all the products identified as being compliant to Directive 2002/95/EC conform to Directive 2011/65/EU.**

**Vishay Intertechnology, Inc. hereby certifies that all its products that are identified as Halogen-Free follow Halogen-Free requirements as per JEDEC JS709A standards. Please note that some Vishay documentation may still make reference to the IEC 61249-2-21 definition. We confirm that all the products identified as being compliant to IEC 61249-2-21 conform to JEDEC JS709A standards.**

## Данный компонент на территории Российской Федерации

### Вы можете приобрести в компании MosChip.

Для оперативного оформления запроса Вам необходимо перейти по данной ссылке:

<http://moschip.ru/get-element>

Вы можете разместить у нас заказ для любого Вашего проекта, будь то серийное производство или разработка единичного прибора.

В нашем ассортименте представлены ведущие мировые производители активных и пассивных электронных компонентов.

Нашей специализацией является поставка электронной компонентной базы двойного назначения, продукции таких производителей как XILINX, Intel (ex.ALTERA), Vicor, Microchip, Texas Instruments, Analog Devices, Mini-Circuits, Amphenol, Glenair.

Сотрудничество с глобальными дистрибьюторами электронных компонентов, предоставляет возможность заказывать и получать с международных складов практически любой перечень компонентов в оптимальные для Вас сроки.

На всех этапах разработки и производства наши партнеры могут получить квалифицированную поддержку опытных инженеров.

Система менеджмента качества компании отвечает требованиям в соответствии с ГОСТ Р ИСО 9001, ГОСТ РВ 0015-002 и ЭС РД 009

### Офис по работе с юридическими лицами:

105318, г.Москва, ул.Щербаковская д.3, офис 1107, 1118, ДЦ «Щербаковский»

Телефон: +7 495 668-12-70 (многоканальный)

Факс: +7 495 668-12-70 (доб.304)

E-mail: [info@moschip.ru](mailto:info@moschip.ru)

Skype отдела продаж:

moschip.ru

moschip.ru\_4

moschip.ru\_6

moschip.ru\_9