

## Main

Range of product	Preventa Safety detection
Product or component type	Safety light curtain type 4
Device short name	XUSL4E
Output type	2 safety outputs OSSD solid-state PNP (integrated arc suppression)
Product specific application	For hand protection
Minimum object diameter for detection	1.18 in (30 mm)
[Sn] nominal sensing distance	0...12 m by cabling 0...4 m by cabling
Height protected	18.11 in (460 mm)
Number of beams	23
Type of start	Automatic Manual
Control type	Selected by wiring

## Complementary

Detection system	Transmitter-receiver system
Kit composition	Adjustable mounting bracket(s) 1 receiver(s) 1 transmitter(s) 1 user guide with certificate of conformity on CD-ROM
[EAA] effective aperture angle	+/- 2.5 ° at 3 m
Emission	IR LED ( $\lambda = 950$ nm)
[Us] rated supply voltage	24 V DC (+/- 20 %)
Supply	Power supply must meet requirements of IEC 61496-1 Power supply must meet requirements of IEC 60204-1
[Ie] rated operational current	2 A
Current consumption	42 mA no-load (transmitter) 83 mA no-load (receiver) 42 mA (transmitter) 900 mA with maximum load (receiver)
Output current limits	0.4 A for safety outputs OSSD
Output voltage	24 V
Output circuit type	DC
Voltage drop	$\leq 0.5$ V
Local signalling	1 multi-colour LED (transmitter) 2 dual colour LEDs (receiver)
Electrical connection	1 male connector M12 5 pins (transmitter) 1 male connector M12 8 pins (receiver)
Function available	Test Muting through external safety module XPSLCMUT1160 LED display of operating modes and faults
Marking	CE
Material	Casing : aluminium Front panel: polycarbonate End caps: polypropylene
Housing colour	RAL 3000: red
Fixing mode	By fixing brackets
Product weight	2.25 lb(US) (1.02 kg)
Offer type	Standard distance

## Environment

directives	89/336/EEC - electromagnetic compatibility 2002/96/EC - WEEE directive 2002/95/EC - RoHS directive 98/37/EEC - machinery 89/655/EEC - work equipment
product certifications	CE CULus TÜV
safety level	SIL 3 conforming to IEC 61508 Type 4 conforming to IEC 61496-1 SILCL 3 conforming to IEC 62061 Category 4 conforming to EN/ISO 13849-1 PL = e conforming to EN/ISO 13849-1
environmental characteristic	Resistance to light disturbance conforming to EN/IEC 61496-2
service life	20 yr
safety reliability data	PFHd = 9.47E-9 1/h conforming to IEC 61508
ambient air temperature for operation	-22...131 °F (-30...55 °C) 14...131 °F
ambient air temperature for storage	-31...158 °F (-35...70 °C) -13...158 °F
relative humidity	0...95 % without condensation
IP degree of protection	IP65 IP67
shock resistance	10 gn 16 ms conforming to IEC 61496-1
vibration resistance	0.35 +/- 0.05 mm (f = 10...55 Hz) conforming to IEC 61496-1

## Offer Sustainability

Green Premium product	Green Premium product
Compliant - since 1425 - Schneider Electric declaration of conformity	Compliant - since 1425 - Schneider Electric declaration of conformity
Reference not containing SVHC above the threshold	Reference not containing SVHC above the threshold
Available	Available
Available	Available
WARNING: This product can expose you to chemicals including:	WARNING: This product can expose you to chemicals including:
Diisononyl phthalate (DINP), which is known to the State of California to cause cancer, and	Diisononyl phthalate (DINP), which is known to the State of California to cause cancer, and
Di-isodecyl phthalate (DIDP), which is known to the State of California to cause birth defects or other reproductive harm.	Di-isodecyl phthalate (DIDP), which is known to the State of California to cause birth defects or other reproductive harm.
For more information go to <a href="http://www.p65warnings.ca.gov">www.p65warnings.ca.gov</a>	For more information go to <a href="http://www.p65warnings.ca.gov">www.p65warnings.ca.gov</a>

## Dimensions

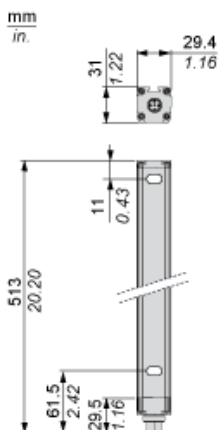

## Brackets Dimensions

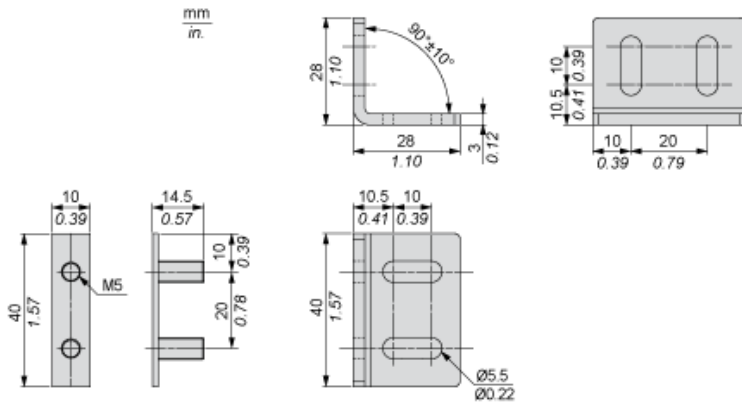

## Mounting and Clearance



- (1) Insert
- (2) Bracket
- (3) Washer
- (4) Spring washer
- (5) Nut

## Wiring Diagrams

### Transmitter Connections



- (1) +24 Vdc
- (2) Master/Slave\_A
- (3) 0 Vdc
- (4) Master/Slave\_B
- (5) FE

### Receiver Connections



- (1) +24 Vdc
- (2) Master/Slave\_A
- (3) 0 Vdc
- (4) Master/Slave\_B
- (5) FE

## Данный компонент на территории Российской Федерации

### Вы можете приобрести в компании MosChip.

Для оперативного оформления запроса Вам необходимо перейти по данной ссылке:

<http://moschip.ru/get-element>

Вы можете разместить у нас заказ для любого Вашего проекта, будь то серийное производство или разработка единичного прибора.

В нашем ассортименте представлены ведущие мировые производители активных и пассивных электронных компонентов.

Нашей специализацией является поставка электронной компонентной базы двойного назначения, продукции таких производителей как XILINX, Intel (ex.ALTERA), Vicor, Microchip, Texas Instruments, Analog Devices, Mini-Circuits, Amphenol, Glenair.

Сотрудничество с глобальными дистрибьюторами электронных компонентов, предоставляет возможность заказывать и получать с международных складов практически любой перечень компонентов в оптимальные для Вас сроки.

На всех этапах разработки и производства наши партнеры могут получить квалифицированную поддержку опытных инженеров.

Система менеджмента качества компании отвечает требованиям в соответствии с ГОСТ Р ИСО 9001, ГОСТ РВ 0015-002 и ЭС РД 009

### Офис по работе с юридическими лицами:

105318, г.Москва, ул.Щербаковская д.3, офис 1107, 1118, ДЦ «Щербаковский»

Телефон: +7 495 668-12-70 (многоканальный)

Факс: +7 495 668-12-70 (доб.304)

E-mail: [info@moschip.ru](mailto:info@moschip.ru)

Skype отдела продаж:

moschip.ru

moschip.ru\_4

moschip.ru\_6

moschip.ru\_9