

PRODUCT NO.
10018784-X0XXXX

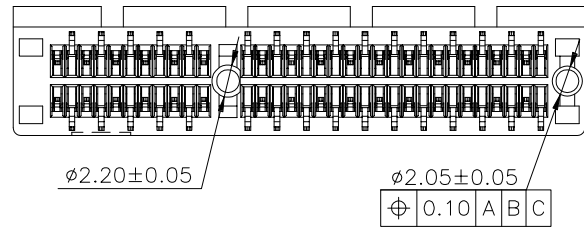

SECTION P-P

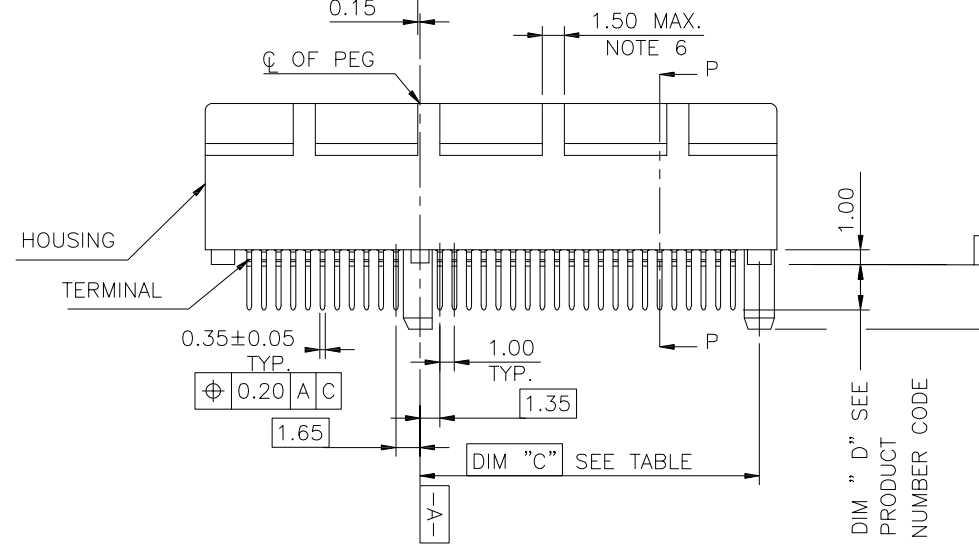
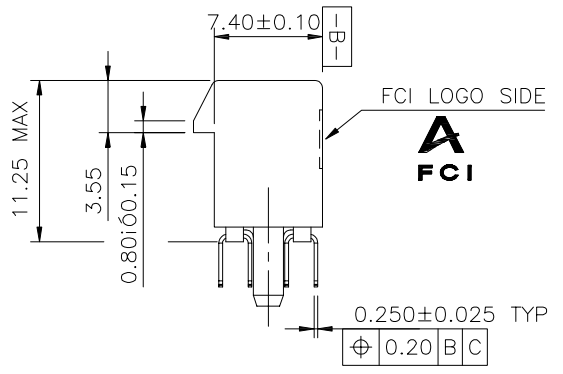

PLASTIC PEG TYPE

CONFIDENTIAL

mat'l. code				tolerances unless otherwise specified			CUSTOMER COPY	FCI www.fciconnect.com		
ltr	ecn no	dr	date	linear	.X ± 0.30	projection		title		
M	T05-0124	M W	06/07/05		.XX ± 0.20		PCI EXPRESS GEN3			
N	T05-0153	M W	07/12/05		.XXX ± 0.10		CARD EDGE ASSY			
P	T05-0208	M W	09/15/05	angles	0° ±2°		product family	EDGE CARD	code	
R	T06-0206	R C	12/01/06	dr	STONE LI 05/27/15		size	dwg no	TWN	
S	ELX-DG-2161-1	S T	05/27/15	enrg	STONE LI 05/27/15	scale	A4	10018784	sheet	
				chr	/	2:1			1 of 6	
				appd	PM ZHENG 05/27/15					
sheet index	revision sheet	S 1	S 2	S 3	S 4	S 5	S 6			

cage code
22526

PRODUCT NO.
10018784-X1XXXX



METAL BOARD LOCKS TYPE

CONFIDENTIAL



mat'l. code				tolerances unless otherwise specified		CUSTOMER COPY			
ltr	ecn no	dr	date	linear	.X ± 0.30	projection			
				angles	.XX ± 0.20				
				dr	.XXX ± 0.10				
				enr	0° ±2°	MM	product family		
				chr	STONE LI 05/27/15		EDGE CARD	code	
				appd	STONE LI 05/27/15		scale	size dwg no	TWN
					PM ZHENG 05/27/15	2:1	A4	10018784	sheet
sheet index	revision sheet								2 of

 www.fciconnect.com		
title PCI EXPRESS GEN3 CARD EDGE ASSY		
product family	EDGE CARD	code
size dwg no		TWN
A4	10018784	sheet
		2 of



← I/O PANEL DIRECTION

RECOMMENDED FOOTPRINT

CONFIDENTIAL

mat'l. code				tolerances unless otherwise specified			CUSTOMER COPY		 www.fciconnect.com		
ltr	ecn no	dr	date	linear	.X ±		projection	title			
					.XX ±			PCI EXPRESS GEN3			
					.XXX ±			CARD EDGE ASS'Y			
				angles	0° ±2°		 MM	product family		code	
				dr	STONE LI	05/27/15		EDGE CARD		TWN	
				enr	STONE LI	05/27/15		size	dwg no	sheet	
				chr	/	/	scale	A4		3 of	
				appd	PM ZHENG	05/27/15	2:1	10018784			
sheet index	revision sheet										

cage code
22526



SCALE 2:1

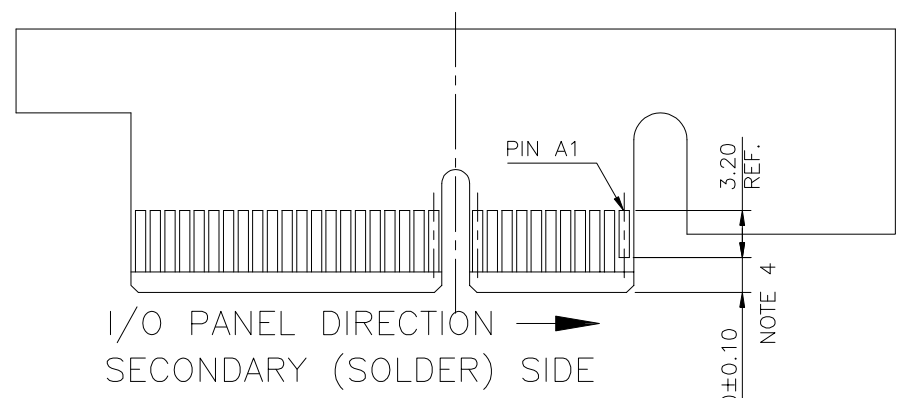

ADD-IN CARD EDGE-FINGER DIMENSIONS

#	POS	REF.	N	DIM "G"	"F"
36	6		6	8.15	B17
64	20		20	22.15	B31
98	37		37	39.15	B48
164	70		70	72.15	B81

PIN "F" SEE TABLE 2.40±0.10

CONFIDENTIAL

mat'l. code				tolerances unless otherwise specified		CUSTOMER COPY	 www.fciconnect.com		
ltr	ecn no	dr	date	linear	.X ±		projection	title	
					.XX ±			PCI EXPRESS GEN3	
				angles	.XXX ±			CARD EDGE ASS'Y	
				dr	0° ±2°	MM	product family		
				enr				EDGE CARD	
				chr		scale	size		
				appd				dwg no	
						2:1	A4	10018784	code
sheet index	revision sheet								TWN
									sheet 4 of

cage code 22526

NOTES:

1.MATERIAL:

HOUSING: NYLON, GLASS FILLED UL94V-0 RATE, SUITABLE FOR WAVE SOLDERING.

TERMINAL: COPPER ALLOY

PLATING: 50u" NICKEL UNDERPLATE ALL OVER CONTACT AREA PLATING - SEE PRODUCT NUMBER CODE SOLDER TAIL: TIN/LEAD (90/10) - SEE PRODUCT NUMBER CODE 100u" MIN. OVER 50u" NICKEL

METAL BOARD LOCKS: COPPER ALLOY FINISH: 100u" TIN/LEAD (90/10) OVER 50u" NICKEL UNDERPLATE SEE PRODUCT NUMBER CODE

2.PRODUCT SPECIFICATION: GS-12-233

③THE HORIZONTAL AXIS FOR THE HOLE PATTERN IS ESTABLISHED BY A LINE THROUGH THE CENTER OF THE TWO Ø2.35 HOLES. THE VERTICAL AXIS IS 90° TO THE HORIZONTAL AXIS, THROUGH THE CENTER OF DATUM Z.

④NO TIE BAR PERMITTED FROM CARD EDGE TO LEADING EDGE OF PAD FOR PINS A1 AND PIN NUMBERS "F".

⑤CHAMFER EDGES MUST BE FREE OF CUTTING BURRS.

⑥FREQUENCY & LOCATION AT SUPPLIER DISCRETION. RIDGE MAY BE CONTINUOUS WITH NO BREAKS.

7.RoHS COMPATIBLE PRODUCT SPECIFICATIONS

a - PLATING:

- "LF" MEANS THE PRODUCT IS LEAD-FREE, 2um MINIMUM MATTE TIN OVER 1.27um MINIMUM NICKEL UNDERPLATE.

b - MANUFACTURING PROCESS COMPATIBILITY

- THE HOUSING WILL WITHSTAND EXPOSURE TO 260°C±5°C SOLDER BATH TEMPERATURE FOR 5 SECONDS IN A WAVE SOLDER APPLICATION WITH A 1.6mm MIN THICK CIRCUIT BOARD.

- THE HOUSING WILL WITHSTAND EXPOSURE TO 240°C±5°C SOLDER BATH TEMPERATURE FOR 5 SECONDS IN A WAVE SOLDER APPLICATION WITH A 1.6mm MIN THICK CIRCUIT BOARD.(For 10018784-X 0 X X X X(X X) options)

CONNECTOR	# POS REF.	N	DIM "A"	DIM "B"	DIM "C"	"E"
1 PORT	36	6	7.65	25.00	9.15	6.00
4 PORT	64	20	21.65	39.00	23.15	20.00
8 PORT	98	37	38.65	56.00	40.15	37.00
16 PORT	164	70	71.65	89.00	73.15	70.00

PRODUCT NUMBER CODE
10018784-x x x x x x □ □

HOUSING COLOR OPTIONS

- 0-WHITE
- 1-BLACK

PEGS OPTIONS

- 0-PLASTIC PEGS
- 1-METAL BOARD LOCKS

TERMINAL PLATING OPTIONS

- 0-50u" Ni UNDERPLATE
30u" Au CONTACT AREA
100u" TIN TAIL AREA ----- COMPATIBLE RoHS
- 1-50u" Ni UNDERPLATE
15u" Au CONTACT AREA
100u" TIN TAIL AREA ----- COMPATIBLE RoHS
- 2-50u" Ni UNDERPLATE
GOLD FLASH CONTACT AREA
100u" TIN TAIL AREA ----- COMPATIBLE RoHS
- 3-50u" Ni UNDERPLATE
30u" Au CONTACT AREA
100u" TIN/LEAD TAIL AREA ----- INCOMPLIANT RoHS
- 4-50u" Ni UNDERPLATE
15u" Au CONTACT AREA
100u" TIN/LEAD TAIL AREA ----- INCOMPLIANT RoHS
- 5-50u" Ni UNDERPLATE
GOLD FLASH CONTACT AREA
100u" TIN/LEAD TAIL AREA ----- INCOMPLIANT RoHS

LEAD FREE OPTION

LEAVE BLANK FOR TERMINAL PLATING 3,4,5
"LF" FOR TERMINAL PLATING OPTION 0,1,2

POS OPTIONS

- 0-36
- 1-64
- 2-98
- 3-164



PACKAGING OPTIONS

T-TRAY PACKAGING
M-TRAY PACKAGING & MYLAR TAPE FOR PICK-N-PLACE. SEE FIGURE 1

TAIL LENGTH OPTIONS

	DIM "D"	PCB THICKNESS	BOARD LOCKS DIM"G"
0	2.30 ± 0.25 ± 0.13	1.56±0.10	1.70±0.15
1	3.10 ± 0.25 ± 0.13	2.36±0.10	2.50±0.15

CONFIDENTIAL

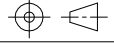
mat'l. code				tolerances unless otherwise specified			CUSTOMER COPY		 www.fciconnect.com		
ltr	ecn no	dr	date	linear	.X ±			projection	title		
					.XX ±				PCI EXPRESS GEN3 CARD EDGE ASS'Y 		
					.XXX ±				product family EDGE CARD code		
				angles	0° ±2°			 MM	size		TWN
				dr	STONE LI	05/27/15	10018784		sheet		
				enr	STONE LI	05/27/15	5 of				
				chr	/	/	A4				
				appd	PM ZHENG	05/27/15	scale 1:1				
sheet index	revision sheet										

cage code
22526



FIGURE 1

CONFIDENTIAL

mat'l. code				tolerances unless otherwise specified			CUSTOMER COPY	 www.fciconnect.com								
ltr	ecn no	dr	date	linear	.X ± 0.25						projection	 title				
					.XX ± 0.13											
					.XXX ± 0.05											
				angles	0° ± 2°		 MM	product family EDGE CARD size dwg no		code						
				dr	STONE LI	05/27/15				scale	A4		TWN			
				enr	STONE LI	05/27/15							1.5:1	10018784		sheet
				chr	/	/										6 of
				appd	PM ZHENG	05/27/15										
sheet index	revision sheet															

cage code 22526

Данный компонент на территории Российской Федерации

Вы можете приобрести в компании MosChip.

Для оперативного оформления запроса Вам необходимо перейти по данной ссылке:

<http://moschip.ru/get-element>

Вы можете разместить у нас заказ для любого Вашего проекта, будь то серийное производство или разработка единичного прибора.

В нашем ассортименте представлены ведущие мировые производители активных и пассивных электронных компонентов.

Нашей специализацией является поставка электронной компонентной базы двойного назначения, продукции таких производителей как XILINX, Intel (ex.ALTERA), Vicor, Microchip, Texas Instruments, Analog Devices, Mini-Circuits, Amphenol, Glenair.

Сотрудничество с глобальными дистрибьюторами электронных компонентов, предоставляет возможность заказывать и получать с международных складов практически любой перечень компонентов в оптимальные для Вас сроки.

На всех этапах разработки и производства наши партнеры могут получить квалифицированную поддержку опытных инженеров.

Система менеджмента качества компании отвечает требованиям в соответствии с ГОСТ Р ИСО 9001, ГОСТ РВ 0015-002 и ЭС РД 009

Офис по работе с юридическими лицами:

105318, г.Москва, ул.Щербаковская д.3, офис 1107, 1118, ДЦ «Щербаковский»

Телефон: +7 495 668-12-70 (многоканальный)

Факс: +7 495 668-12-70 (доб.304)

E-mail: info@moschip.ru

Skype отдела продаж:

moschip.ru

moschip.ru_4

moschip.ru_6

moschip.ru_9