

# YAS5

YA S 5 05 E

① ② ③ ④ ⑤



RoHS

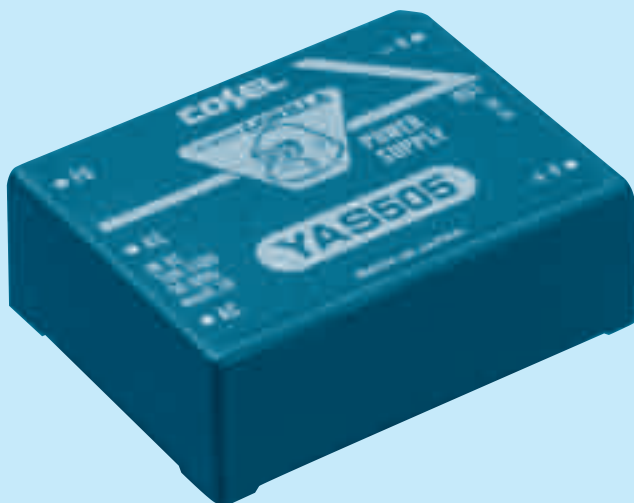

- ① Series name
- ② Single output
- ③ Output wattage
- ④ Output voltage
- ⑤ UL recognized, TÜV approved, CSA certified: E

MODEL	YAS505	YAS512
MAX OUTPUT WATTAGE[W]	5.0	5.4
DC OUTPUT	5V 1.0A	12V 0.45A

## SPECIFICATIONS

	MODEL	YAS505	YAS512	
INPUT	VOLTAGE[V]	AC85 - 264 1 φ or DC110 - 370		
	CURRENT[A]	ACIN 200V	0.07typ (Io=100%)	
	FREQUENCY[Hz]	47 - 440 or DC		
	EFFICIENCY[%]	65typ		
	INRUSH CURRENT[A]	ACIN 100V	20typ (Io=100%)	67typ
		ACIN 200V	40typ (Io=100%)	
OUTPUT	VOLTAGE[V]	5	12	
	CURRENT[A]	1	0.45	
	LINE REGULATION[mV]	20max	48max	
	LOAD REGULATION[mV]	40max	100max	
	RIPPLE[mVp-p]	*1 80max	120max	
	RIPPLE NOISE[mVp-p]	*1 120max	150max	
	TEMPERATURE REGULATION[mV]	0 to +55°C	50max	150max
	OUTPUT VOLTAGE ADJUSTMENT RANGE[V]	Fixed		
OUTPUT VOLTAGE SETTING[%]	±5max (Rated input/output, Ta=25°C)			
HOLD-UP TIME[ms]	10typ (ACIN 85V, Io=100%)			
PROTECTION CIRCUIT	OVERCURRENT PROTECTION	Works over 105% of rating and recovers automatically		
ISOLATION	INPUT-OUTPUT	AC3,000V 1minute, Cutoff current = 15mA, DC500V 50MΩmin (At Room Temperature)		
	INPUT-FG	AC2,000V 1minute, Cutoff current = 10mA, DC500V 50MΩmin (At Room Temperature)		
	OUTPUT-FG	AC500V 1minute, Cutoff current=100mA, DC500V 50MΩmin (At Room Temperature)		
ENVIRONMENT	OPERATING TEMP., HUMID. AND ALTITUDE	-10 to +70°C, 20 - 95%RH (Non condensing) (Refer to DERATING CURVE), 3,000m (10,000feet) max		
	STORAGE TEMP., HUMID. AND ALTITUDE	-20 to +75°C, 20 - 95%RH (Non condensing), 9,000m (30,000feet) max		
	VIBRATION	10 - 55Hz, 98.0m/s <sup>2</sup> (10G), 3minutes period, 60minutes each along X, Y and Z axis		
	IMPACT	490.3m/s <sup>2</sup> (50G), 11ms, once each X, Y and Z axis		
SAFETY AND NOISE REGULATIONS	AGENCY APPROVALS	UL60950-1, EN60950-1, EN50178, CSA C22.2 No.60950-1 Complies with IEC60950-1		
	CONDUCTED NOISE	Complies with FCC-B, VCCI-B, Additional capacitors required for meeting CISPR22-B, EN55022-B (External Fuse is required)		

\*1 Measured by 20MHz oscilloscope.  
\* Parallel operation with other model is not possible.

External view

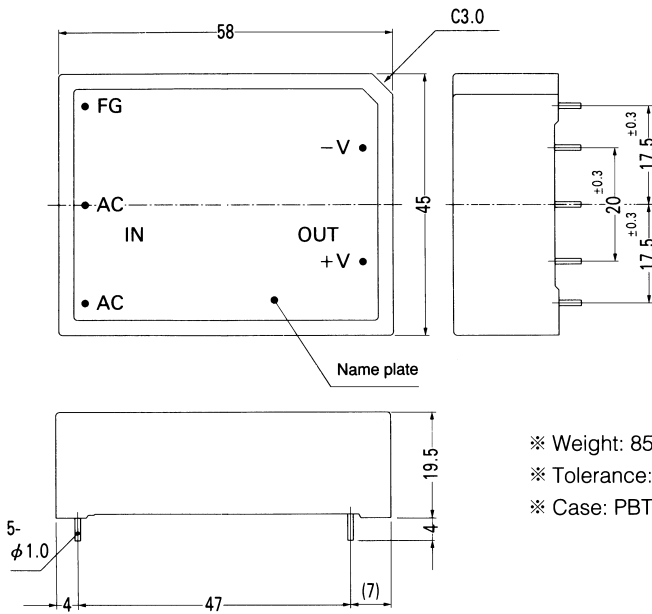

- ※ Weight: 85g or less
- ※ Tolerance: ±0.5
- ※ Case: PBT

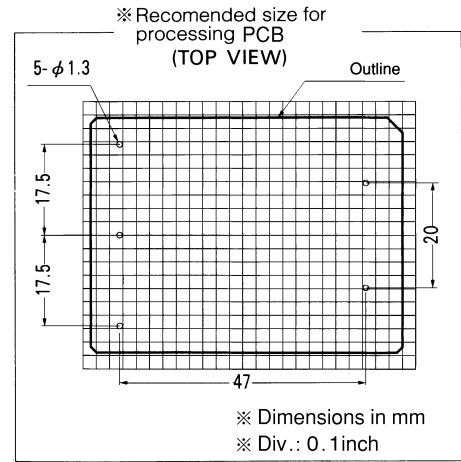

- ※ Dimensions in mm
- ※ Div.: 0.1inch

Performance data

■ STATIC CHARACTERISTICS (YAS512)

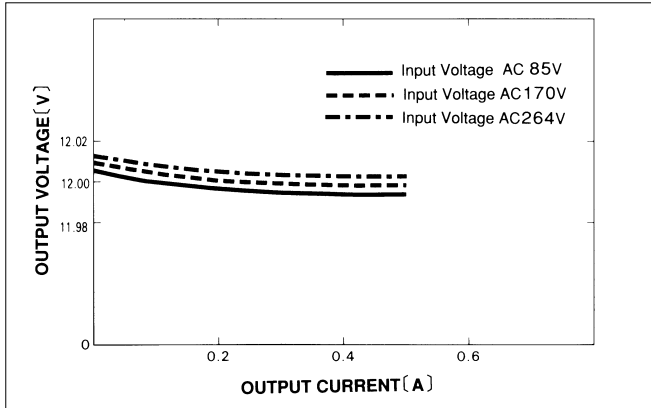

■ RISE TIME (YAS512)

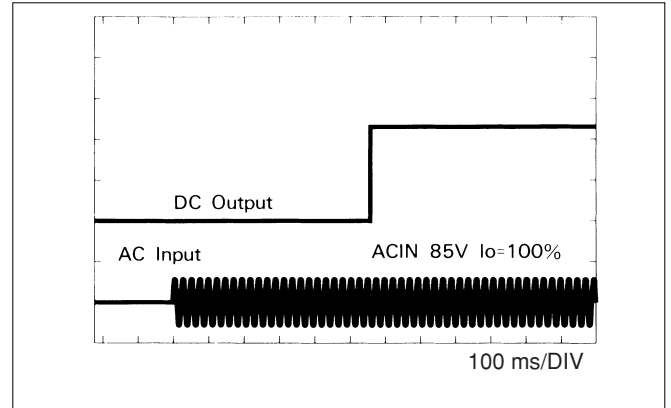

■ OVERCURRENT CHARACTERISTICS (YAS512)

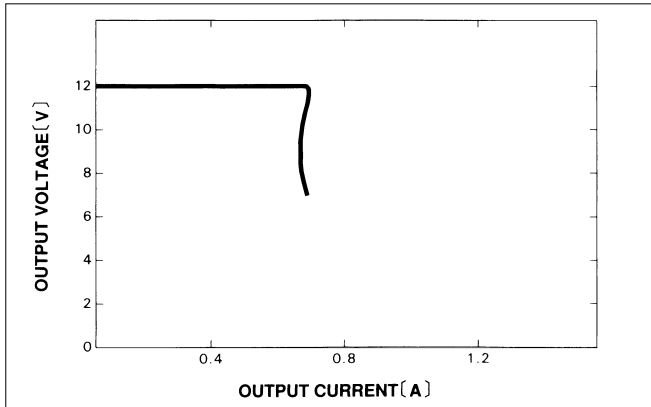

■ DERATING CURVE

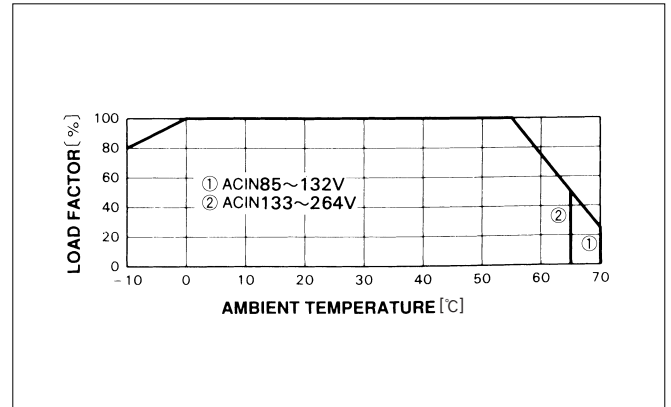

# YAS10

YA S 10 05 E

① ② ③ ④ ⑤

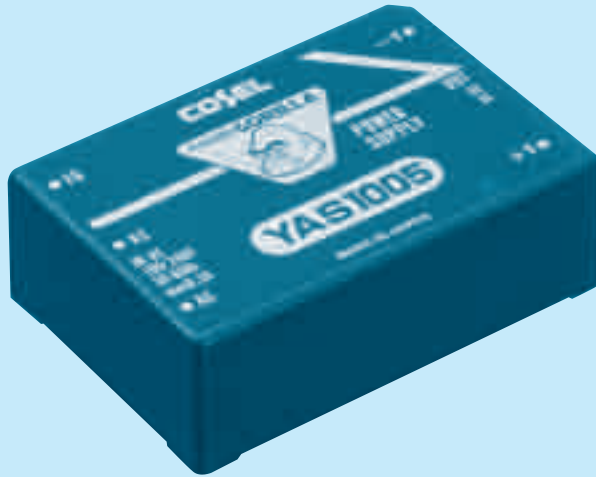

- ① Series name
- ② Single output
- ③ Output wattage
- ④ Output voltage
- ⑤ UL recognized, TÜV approved, CSA certified: E

MODEL	YAS1005	YAS1012
MAX OUTPUT WATTAGE[W]	10.0	10.8
DC OUTPUT	5V 2.0A	12V 0.9A

## SPECIFICATIONS

	MODEL	YAS1005	YAS1012	
INPUT	VOLTAGE[V]	AC85 - 264 1 φ or DC110 - 370		
	CURRENT[A]	ACIN 200V	0.14typ (Io=100%)	
	FREQUENCY[Hz]	47 - 440 or DC		
	EFFICIENCY[%]	70typ		
	INRUSH CURRENT[A]	ACIN 100V	20typ (Io=100%)	
		ACIN 200V	40typ (Io=100%)	
OUTPUT	VOLTAGE[V]	5	12	
	CURRENT[A]	2	0.9	
	LINE REGULATION[mV]	20max	48max	
	LOAD REGULATION[mV]	40max	100max	
	RIPPLE[mVp-p]	*1 80max	120max	
	RIPPLE NOISE[mVp-p]	*1 120max	150max	
	TEMPERATURE REGULATION[mV]	0 to +55°C	50max	
	OUTPUT VOLTAGE ADJUSTMENT RANGE[V]	Fixed		
	OUTPUT VOLTAGE SETTING[%]	±5max (Rated input/output, Ta=25°C)		
HOLD-UP TIME[ms]	10typ (ACIN 85V, Io=100%)			
PROTECTION CIRCUIT	OVERCURRENT PROTECTION	Works over 105% of rating and recovers automatically		
ISOLATION	INPUT-OUTPUT	AC3,000V 1minute, Cutoff current = 15mA, DC500V 50MΩmin (At Room Temperature)		
	INPUT-FG	AC2,000V 1minute, Cutoff current = 10mA, DC500V 50MΩmin (At Room Temperature)		
	OUTPUT-FG	AC500V 1minute, Cutoff current=100mA, DC500V 50MΩmin (At Room Temperature)		
ENVIRONMENT	OPERATING TEMP., HUMID. AND ALTITUDE	-10 to +70°C, 20 - 95%RH (Non condensing) (Refer to DERATING CURVE), 3,000m (10,000feet) max		
	STORAGE TEMP., HUMID. AND ALTITUDE	-20 to +75°C, 20 - 95%RH (Non condensing), 9,000m (30,000feet) max		
	VIBRATION	10 - 55Hz, 98.0m/s <sup>2</sup> (10G), 3minutes period, 60minutes each along X, Y and Z axis		
	IMPACT	490.3m/s <sup>2</sup> (50G), 11ms, once each X, Y and Z axis		
SAFETY AND NOISE REGULATIONS	AGENCY APPROVALS	UL60950-1, EN60950-1, EN50178, CSA C22.2 No.60950-1 Complies with IEC60950-1		
	CONDUCTED NOISE	Complies with FCC-B, VCCI-B, Additional capacitors required for meeting CISPR22-B, EN55022-B (External Fuse is required)		

\*1 Measured by 20MHz oscilloscope.  
\* Parallel operation with other model is not possible.

External view

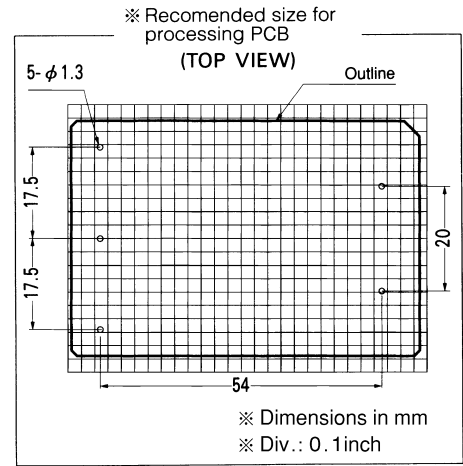
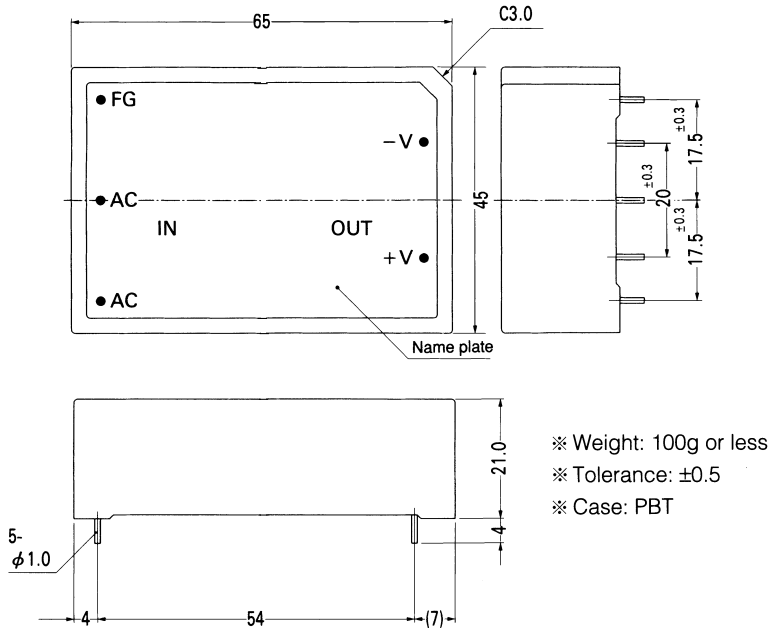

Performance data

■ STATIC CHARACTERISTICS (YAS1012)

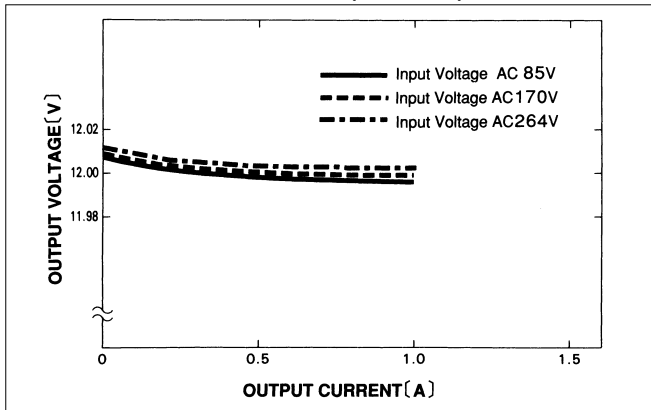

■ RISE TIME (YAS1012)

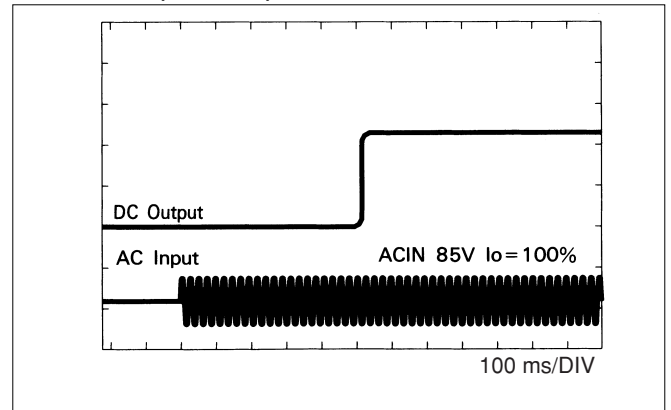

■ OVERCURRENT CHARACTERISTICS (YAS1012)

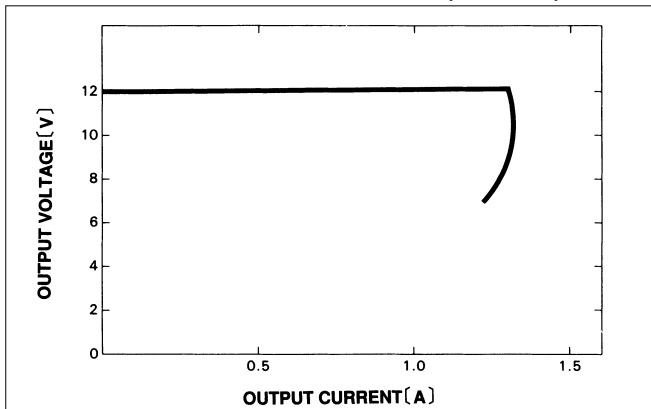

■ DERATING CURVE

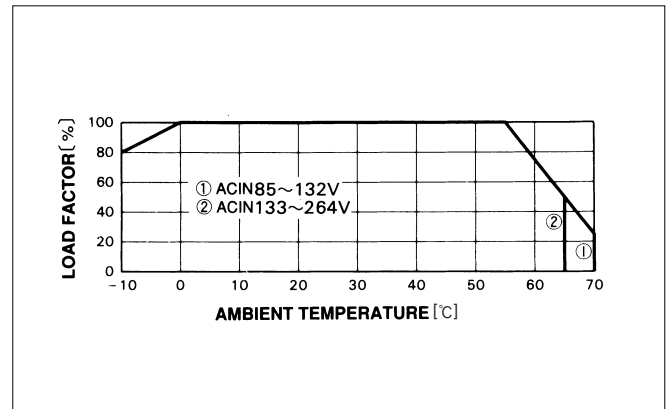

# Mouser Electronics

Authorized Distributor

Click to View Pricing, Inventory, Delivery & Lifecycle Information:

Cosel:

[YAS1012](#) [YAS505E](#) [YAS1005E](#) [YAS505](#) [YAS1005](#) [YAS512](#) [YAS512E](#) [YAS1012E](#)

## Данный компонент на территории Российской Федерации

### Вы можете приобрести в компании MosChip.

Для оперативного оформления запроса Вам необходимо перейти по данной ссылке:

<http://moschip.ru/get-element>

Вы можете разместить у нас заказ для любого Вашего проекта, будь то серийное производство или разработка единичного прибора.

В нашем ассортименте представлены ведущие мировые производители активных и пассивных электронных компонентов.

Распределительные склады, находящиеся в России, Европе и в Китае, позволяют нам оперативно поставить необходимые компоненты в оптимальные для Вас сроки.

На всех этапах разработки и производства наши партнеры могут получить квалифицированную поддержку опытных инженеров.

Система менеджмента качества компании отвечает требованиям ISO 9001:2011

### Офис по работе с юридическими лицами:

107023, г.Москва, Семеновский переулок, д.6, Бизнес-центр «АВС»

Телефон: +7 495 668-12-70 (многоканальный)

Факс: +7 495 668-12-70 (доб.304)

E-mail: [info@moschip.ru](mailto:info@moschip.ru)

Skype отдела продаж:

moschip.ru_3	moschip.ru_6
moschip.ru_4	moschip.ru_7
moschip.ru_11	moschip.ru_8
moschip.ru_12	moschip.ru_9