

12mm Rotary Type, Metal Shaft Series

Application

- ✓ Audio, Home appliance, Automotive, Communication

Feature

- ✓ Suit for various applications



■Specification

Total Rotational Angle	300±5°
Maximum Operating Voltage	100V AC
Insulation Resistance	50MΩ at DC500V
Dielectric Strength	AC 500V for 1 minute
Rotational Torque	RV120DF: 20-150 gf.cm; Others: 10-150 gf.cm
Click Torque	50-300 gf.cm
Rotational Stop Strength of the Shaft	RV120DF: 4 kgf.cm; Others: 3 kgf.cm min
Push/Pull Strength of the Shaft	10kgf for 10 sec
Rotation Life	15,000 cycles

■How to order

RV120F – 10 B1 – 15F – A50K – 0C

Model

Bushing Type

RV120DF-20B1, RV120DF-40B1

Order Code	Length
B1	5 mm

Other Model

Order Code	Length
B1	5 mm
Blank	7 mm

Metal Shaft Type

Click

Model	Order code	Description
RV120DF	1	No click
	1C	With center click
Other	Blank	No click
	0C	With center click

Taper and Resistance Value

Order Code	Taper	Resistance Value
A100K	Log/A	100KΩ
B1M	Linear/B	1MΩ
C500K	Rev-log/C	500KΩ

Taper: A, B and C

Resistance Value: 1KΩ to 500KΩ and 1MΩ

*Contact us for other requirements.

12mm Rotary Type, Metal Shaft Series

■ Model Description

Model	Number of Unit	Switch Function	Terminal Type	With Sleeve or Bushing	Rotational Angle
RV120F-10	Single unit	N/A	Solder lug	Metal bushing	300°±5°
RV120F-20	Single unit	N/A	Horizontal	Metal bushing	300°±5°
RV120F-21	Single unit	N/A	Horizontal	Metal bushing	300°±5°
RV122F-10	Dual unit	N/A	Solder lug	Metal bushing	300°±5°
RV122F-20	Dual unit	N/A	Horizontal	Metal bushing	300°±5°
RV122F-21	Dual unit	N/A	Horizontal	Metal bushing	300°±5°
RV124F-20	Quad unit	N/A	Horizontal	Metal bushing	300°±5°
RV124F-21	Quad unit	N/A	Horizontal	Metal bushing	300°±5°
RV120DF-20B1	Single unit	N/A	Horizontal	Metal bushing	300°±5°
RV120DF-40B1	Single unit	N/A	Vertical	Metal bushing	300°±5°

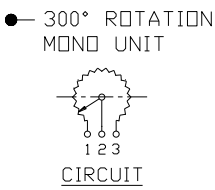
Order Code	Outline Drawing
RV120F-10	  <p>SHAFT SHOWN IN FULL C.C.W. POSITION</p>  <p>● 300° ROTATION MONO UNIT CIRCUIT</p>



[Back to top](#)

12mm Rotary Type, Metal Shaft Series

Order Code	Outline Drawing
RV120F-20 RV120F-21 	 <p>SHAFT SHOWN IN FULL C.C.W. POSITION</p> <p>P.C.B. MOUNTING HOLE DETAIL</p>
RV122F-10 	 <p>SHAFT SHOWN IN FULL C.C.W. POSITION</p>
RV122F-20 RV122F-21 	 <p>SHAFT SHOWN IN FULL C.C.W. POSITION</p> <p>P.C.B. MOUNTING HOLE DETAIL</p>
RV124F-20 RV124F-21 	 <p>SHAFT SHOWN IN FULL C.C.W. POSITION</p> <p>P.C.B. MOUNTING HOLE DETAIL</p>

[Back to top](#)

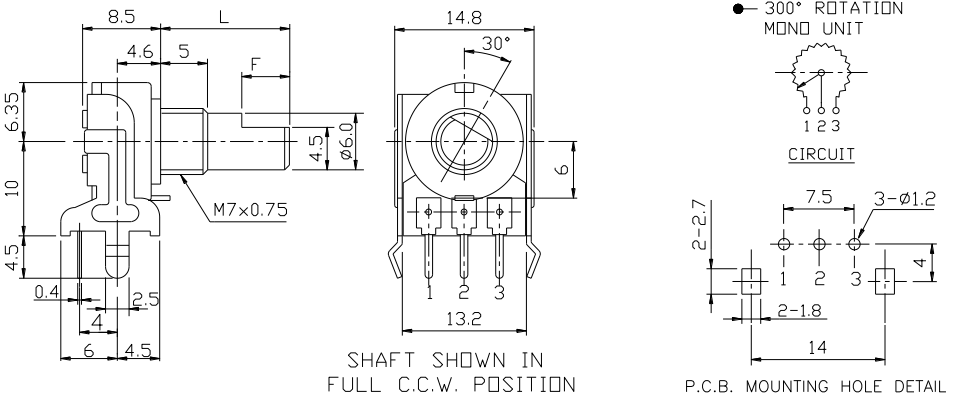
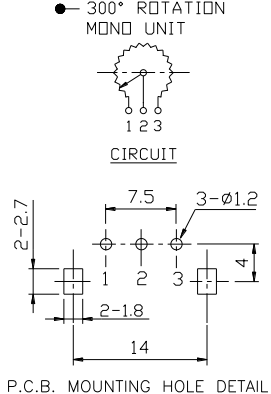
12mm Rotary Type, Metal Shaft Series

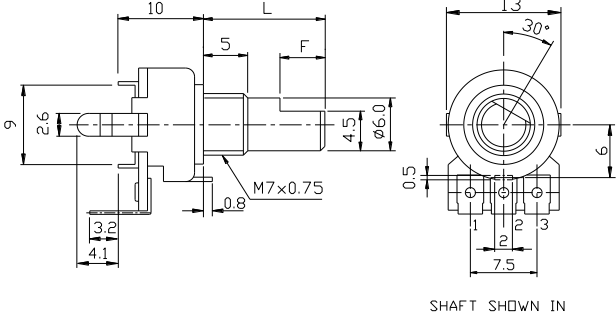
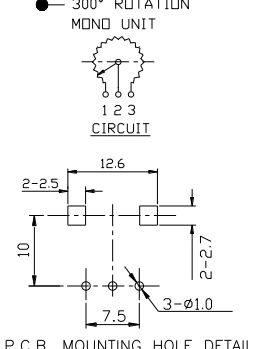
Order Code	Outline Drawing	
<p>RV120DF-20B1</p> 	 <p>SHAFT SHOWN IN FULL C.C.W. POSITION</p>	 <p>P.C.B. MOUNTING HOLE DETAIL</p>
<p>RV120DF-40B1</p> 	 <p>SHAFT SHOWN IN FULL C.C.W. POSITION</p>	 <p>P.C.B. MOUNTING HOLE DETAIL</p>

■ Metal Shaft Type

K Type	RV120DF-20B1 RV120DF-40B1	RV120F Other Models																																								
	<p>A : 5mm</p>	<p>A : 7mm</p>																																								
	<table border="1"> <thead> <tr> <th>Order Code</th> <th>L</th> <th>T</th> <th>F</th> <th>M</th> </tr> </thead> <tbody> <tr> <td>15K</td> <td>15</td> <td>6</td> <td>6.5</td> <td>1</td> </tr> <tr> <td>20K</td> <td>20</td> <td>10</td> <td>11</td> <td>2</td> </tr> <tr> <td>25K</td> <td>25</td> <td>12</td> <td>14</td> <td>4</td> </tr> </tbody> </table>	Order Code	L	T	F	M	15K	15	6	6.5	1	20K	20	10	11	2	25K	25	12	14	4	<table border="1"> <thead> <tr> <th>Order Code</th> <th>L</th> <th>T</th> <th>F</th> <th>M</th> </tr> </thead> <tbody> <tr> <td>15K</td> <td>15</td> <td>6</td> <td>6.5</td> <td>1</td> </tr> <tr> <td>20K</td> <td>20</td> <td>10</td> <td>11</td> <td>2</td> </tr> <tr> <td>25K</td> <td>25</td> <td>12</td> <td>14</td> <td>4</td> </tr> </tbody> </table>	Order Code	L	T	F	M	15K	15	6	6.5	1	20K	20	10	11	2	25K	25	12	14	4
Order Code	L	T	F	M																																						
15K	15	6	6.5	1																																						
20K	20	10	11	2																																						
25K	25	12	14	4																																						
Order Code	L	T	F	M																																						
15K	15	6	6.5	1																																						
20K	20	10	11	2																																						
25K	25	12	14	4																																						

[Back to top](#)

12mm Rotary Type, Metal Shaft Series

■ Metal Shaft Type

F Type 	RV120DF-20B1 RV120DF-40B1	RV120F Other Models																								
R Type 	A : 5mm & 7mm <table border="1" data-bbox="909 1003 1157 1205"> <thead> <tr> <th>Order Code</th> <th>L</th> </tr> </thead> <tbody> <tr> <td>15R</td> <td>15</td> </tr> <tr> <td>20R</td> <td>20</td> </tr> <tr> <td>25R</td> <td>25</td> </tr> </tbody> </table>		Order Code	L	15R	15	20R	20	25R	25																
Order Code	L																									
15R	15																									
20R	20																									
25R	25																									
A : 5mm <table border="1" data-bbox="635 548 954 750"> <thead> <tr> <th>Order Code</th> <th>L</th> <th>F</th> </tr> </thead> <tbody> <tr> <td>15F</td> <td>15</td> <td>7</td> </tr> <tr> <td>20F</td> <td>20</td> <td>12</td> </tr> <tr> <td>25F</td> <td>25</td> <td>14</td> </tr> </tbody> </table>	Order Code	L	F	15F	15	7	20F	20	12	25F	25	14	A : 7mm <table border="1" data-bbox="1114 548 1433 750"> <thead> <tr> <th>Order Code</th> <th>L</th> <th>F</th> </tr> </thead> <tbody> <tr> <td>15F</td> <td>15</td> <td>7</td> </tr> <tr> <td>20F</td> <td>20</td> <td>12</td> </tr> <tr> <td>25F</td> <td>25</td> <td>14</td> </tr> </tbody> </table>		Order Code	L	F	15F	15	7	20F	20	12	25F	25	14
Order Code	L	F																								
15F	15	7																								
20F	20	12																								
25F	25	14																								
Order Code	L	F																								
15F	15	7																								
20F	20	12																								
25F	25	14																								

Design and specifications presented here are for the standard parts only. Please kindly contact us for your special requests and ask for the current technical specifications before purchase and/or use.

[Back to top](#)

Mouser Electronics

Authorized Distributor

Click to View Pricing, Inventory, Delivery & Lifecycle Information:

Alpha (Taiwan):

[RV120F-10-15F-B10K](#) [RV120F-20-15F-B10K](#) [RV120F-20-15F-A10K](#) [RV120F-10-15F-A10K](#) [RV120F-10-15F-B100K](#)
[RV120F-20-15F-B100K](#) [RV120F-20-15F-A100K](#) [RV120F-10-15F-A100K](#) [RV120F-10-15F-A50K](#) [RV120F-20-15F-A50K](#) [RV120F-10-15F-B50K](#) [RV120F-20-15F-B50K](#) [RV120F-10-15F-A1M](#) [RV120F-10-15F-A1K](#) [RV120F-10-15F-A5K](#) [RV120F-20-15F-A1M](#) [RV120F-10-15F-B5K](#) [RV120F-10-15F-B1K](#) [RV120F-10-15F-B1M](#) [RV120F-10-15F-A500K](#)
[RV120F-20-15F-A500K](#) [RV120F-10-15F-B500K](#) [RV120F-20-15F-B500K](#) [RV120F-20-15F-B5K](#) [RV120F-20-15F-B1M](#) [RV120F-20-15F-B1K](#) [RV120F-20-15F-A1K](#) [RV120F-20-15F-A5K](#) [RV120F-20-15K-A20K](#) [RV120F-20-15R-B50K](#)
[RV120F-10-15F-A10K-0075](#) [RV120F-20-15F-B100K-0075](#) [RV120F-10-15F-A5K-0075](#) [RV120F-10-15F-B1K-0075](#) [RV120F-20-15F-A5K-0075](#) [RV120F-20-15F-B5K-0075](#) [RV120F-20-15F-A1M-0075](#) [RV120F-10-15F-A50K-0075](#) [RV120F-10-15F-B5K-0075](#) [RV120F-20-15F-B500K-0075](#) [RV120F-20-15F-B1M-0075](#) [RV120F-10-15F-B1M-0075](#) [RV120F-20-15F-A1K-0075](#) [RV120F-20-15K-A20K-0075](#) [RV120F-10-15F-B10K-0075](#) [RV120F-20-15F-B1K-0075](#) [RV120F-10-15F-A1M-0075](#) [RV120F-10-15F-B100K-0075](#) [RV120F-20-15F-A100K-0075](#) [RV120F-20-15F-A50K-0075](#) [RV120F-20-15F-B50K-0075](#) [RV120F-20-15F-A500K-0075](#) [RV120F-10-15F-A1K-0075](#) [RV120F-10-15F-A500K-0075](#) [RV120F-10-15F-B500K-0075](#) [RV120F-10-15F-B50K-0075](#) [RV120F-10-15F-A100K-0075](#) [RV120F-20-15F-A10K-0075](#) [RV120F-20-15F-B10K-0075](#) [RV120F-20-15R-B50K-0075](#)

Данный компонент на территории Российской Федерации

Вы можете приобрести в компании MosChip.

Для оперативного оформления запроса Вам необходимо перейти по данной ссылке:

<http://moschip.ru/get-element>

Вы можете разместить у нас заказ для любого Вашего проекта, будь то серийное производство или разработка единичного прибора.

В нашем ассортименте представлены ведущие мировые производители активных и пассивных электронных компонентов.

Нашей специализацией является поставка электронной компонентной базы двойного назначения, продукции таких производителей как XILINX, Intel (ex.ALTERA), Vicor, Microchip, Texas Instruments, Analog Devices, Mini-Circuits, Amphenol, Glenair.

Сотрудничество с глобальными дистрибьюторами электронных компонентов, предоставляет возможность заказывать и получать с международных складов практически любой перечень компонентов в оптимальные для Вас сроки.

На всех этапах разработки и производства наши партнеры могут получить квалифицированную поддержку опытных инженеров.

Система менеджмента качества компании отвечает требованиям в соответствии с ГОСТ Р ИСО 9001, ГОСТ РВ 0015-002 и ЭС РД 009

Офис по работе с юридическими лицами:

105318, г.Москва, ул.Щербаковская д.3, офис 1107, 1118, ДЦ «Щербаковский»

Телефон: +7 495 668-12-70 (многоканальный)

Факс: +7 495 668-12-70 (доб.304)

E-mail: info@moschip.ru

Skype отдела продаж:

moschip.ru

moschip.ru_4

moschip.ru_6

moschip.ru_9