



**SINGLE-PHASE GLASS PASSIVATED  
SILICON BRIDGE RECTIFIER**  
VOLTAGE RANGE 50 to 1000 Volts CURRENT 1.5 Amperes

**DB151LS  
THRU  
DB157LS**

**FEATURES**

- \* Good for automation insertion
- \* Surge overload rating - 40 amperes peak
- \* Ideal for printed circuit board
- \* Reliable low cost construction utilizing molded
- \* Glass passivated device
- \* Polarity symbols molded on body
- \* Mounting position: Any
- \* Weight: 1.0 gram

**MECHANICAL DATA**

- \* Epoxy: Device has UL flammability classification 94V-O

**MAXIMUM RATINGS AND ELECTRICAL CHARACTERISTICS**

Ratings at 25 °C ambient temperature unless otherwise specified.  
resistive or inductive load.

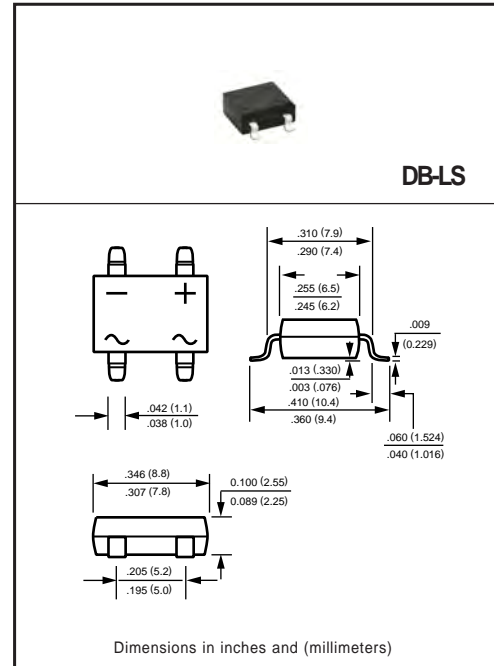

**MAXIMUM RATINGS** (At  $T_A = 25^\circ\text{C}$  unless otherwise noted)

RATINGS	SYMBOL	DB151LS	DB152LS	DB153LS	DB154LS	DB155LS	DB156LS	DB157LS	UNITS
Maximum Recurrent Peak Reverse Voltage	$V_{RRM}$	50	100	200	400	600	800	1000	Volts
Maximum RMS Bridge Input Voltage	$V_{RMS}$	35	70	140	280	420	560	700	Volts
Maximum DC Blocking Voltage	$V_{DC}$	50	100	200	400	600	800	1000	Volts
Maximum Average Forward Output Current at $T_A = 40^\circ\text{C}$	$I_O$	1.5							Amps
Peak Forward Surge Current 8.3 ms single half sine-wave superimposed on rated load (JEDEC method)	$I_{FSM}$	40							Amps
Typical Current Squared Time	$I^2t$	6.6							$\text{A}^2/\text{Sec}$
Typical Thermal Resistance (Note 2)	$R_{\theta JA}$	55							$^\circ\text{C}/\text{W}$
	$R_{\theta JL}$	8							
Operating and Storage Temperature Range	$T_J, T_{STG}$	-55 to + 150							$^\circ\text{C}$

**ELECTRICAL CHARACTERISTICS** (At  $T_A = 25^\circ\text{C}$  unless otherwise noted)

CHARACTERISTICS	SYMBOL	DB151LS	DB152LS	DB153LS	DB154LS	DB155LS	DB156LS	DB157LS	UNITS
Maximum Forward Voltage Drop per Bridge Element at 1.5A DC	$V_F$	1.1							Volts
Maximum Reverse Current at Rated DC Blocking Voltage per element	@ $T_A = 25^\circ\text{C}$	5.0							$\mu\text{Amps}$
	@ $T_A = 125^\circ\text{C}$	0.5							mAmps

- Note: 1. "Fully ROHS compliant", "100% Sn plating (Pb-free).  
2. Thermal Resistance: Mounted on PCB.  
3. Available in Halogen-free epoxy by adding suffix -HF after the part nbr.

## RATING AND CHARACTERISTICS CURVES ( DB151LS THRU DB157LS )

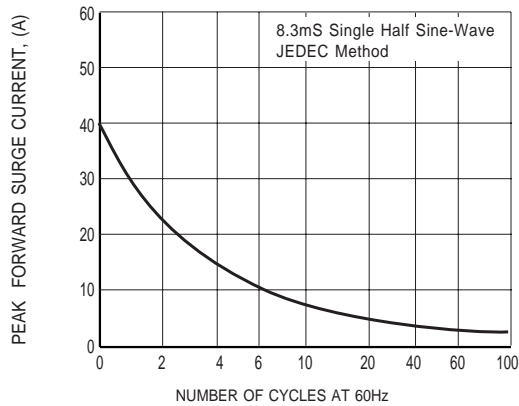

FIG. 1 - MAXIMUM NON-REPETITIVE FORWARD SURGE CURRENT

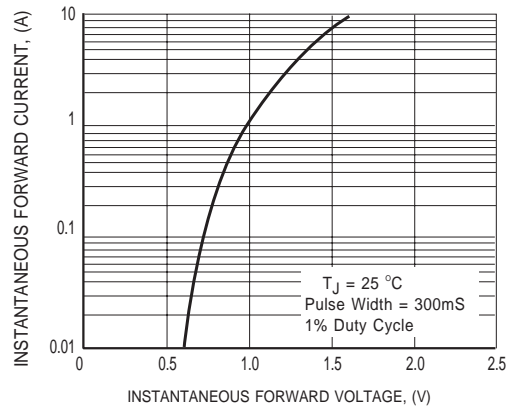

FIG. 2 TYPICAL INSTANTANEOUS FORWARD CHARACTERISTICS

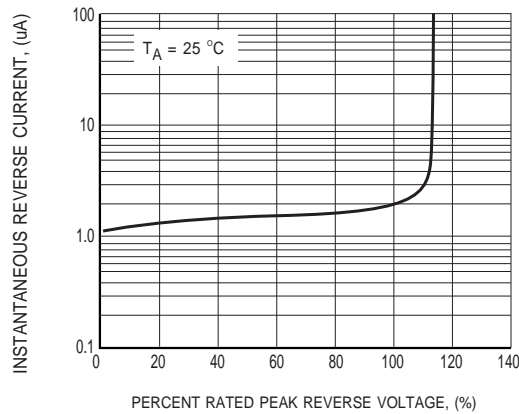

FIG. 3 TYPICAL REVERSE CHARACTERISTICS

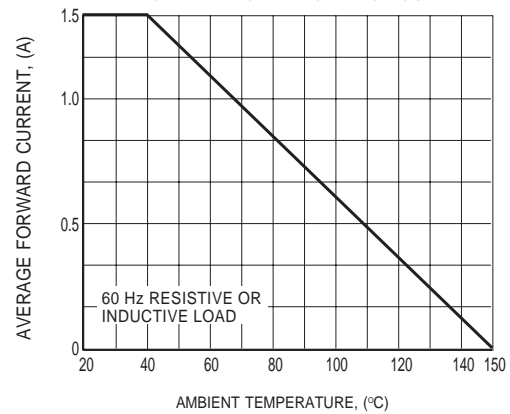
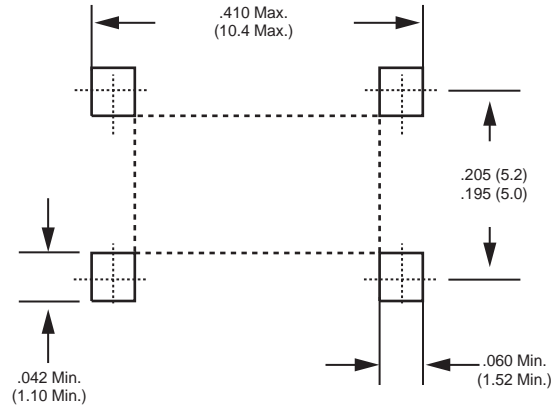

FIG. 4 TYPICAL FORWARD CURRENT DERATING CURVE

## Mounting Pad Layout



Dimensions in inches and (millimeters)

## Marking Description

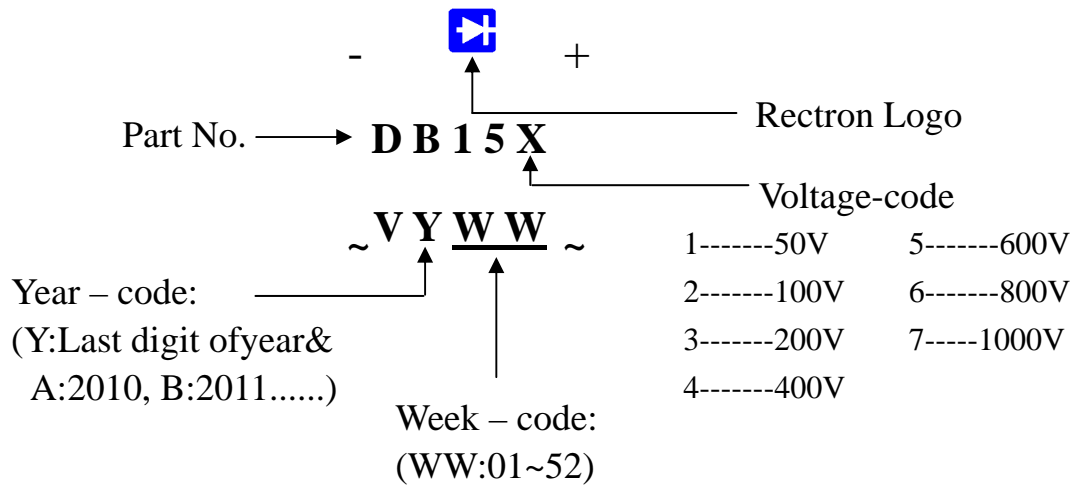

## PACKAGING OF DIODE AND BRIDGE RECTIFIERS

### TUBE PACK

PACKAGE	PACKING CODE	EA PER BOX	INNER BOX SIZE (mm)	CARTON SIZE (mm)	EA PER CARTON	WEIGHT(Kg)
DB-LS	-C	4,000	450*140*84	464*305*283	24,000	16.45

## DISCLAIMER NOTICE

Rectron Inc reserves the right to make changes without notice to any product specification herein, to make corrections, modifications, enhancements or other changes. Rectron Inc or anyone on its behalf assumes no responsibility or liability for any errors or inaccuracies. Data sheet specifications and its information contained are intended to provide a product description only. "Typical" parameters which may be included on RECTRON data sheets and/ or specifications can and do vary in different applications and actual performance may vary over time. Rectron Inc does not assume any liability arising out of the application or use of any product or circuit.

Rectron products are not designed, intended or authorized for use in medical, life-saving implant or other applications intended for life-sustaining or other related applications where a failure or malfunction of component or circuitry may directly or indirectly cause injury or threaten a life without expressed written approval of Rectron Inc. Customers using or selling Rectron components for use in such applications do so at their own risk and shall agree to fully indemnify Rectron Inc and its subsidiaries harmless against all claims, damages and expenditures.

## Данный компонент на территории Российской Федерации

### Вы можете приобрести в компании MosChip.

Для оперативного оформления запроса Вам необходимо перейти по данной ссылке:

<http://moschip.ru/get-element>

Вы можете разместить у нас заказ для любого Вашего проекта, будь то серийное производство или разработка единичного прибора.

В нашем ассортименте представлены ведущие мировые производители активных и пассивных электронных компонентов.

Нашей специализацией является поставка электронной компонентной базы двойного назначения, продукции таких производителей как XILINX, Intel (ex.ALTERA), Vicor, Microchip, Texas Instruments, Analog Devices, Mini-Circuits, Amphenol, Glenair.

Сотрудничество с глобальными дистрибьюторами электронных компонентов, предоставляет возможность заказывать и получать с международных складов практически любой перечень компонентов в оптимальные для Вас сроки.

На всех этапах разработки и производства наши партнеры могут получить квалифицированную поддержку опытных инженеров.

Система менеджмента качества компании отвечает требованиям в соответствии с ГОСТ Р ИСО 9001, ГОСТ РВ 0015-002 и ЭС РД 009

### Офис по работе с юридическими лицами:

105318, г.Москва, ул.Щербаковская д.3, офис 1107, 1118, ДЦ «Щербаковский»

Телефон: +7 495 668-12-70 (многоканальный)

Факс: +7 495 668-12-70 (доб.304)

E-mail: [info@moschip.ru](mailto:info@moschip.ru)

Skype отдела продаж:

moschip.ru

moschip.ru\_4

moschip.ru\_6

moschip.ru\_9