

3M™ MicroTouch™ Controller EX USB Reference Guide

Model	Size	Cased	Connector
EX111	1 X 2	NO	AMP
EX121	2 X 3	NO	12 PIN
EX141	2 X 3	YES	12 PIN
EX151	1 X 2	NO	ZIF

Read and understand all safety information
contained in this document before using this product.

MicroTouch™

3M

The information in this document is subject to change without notice. No part of this document may be reproduced or transmitted in any form or by any means, electronic or mechanical, for any purpose, without the express written permission of 3M Touch Systems, Inc. 3M may have patents or pending patent applications, trademarks, copyrights, or other intellectual property rights covering subject matter in this document. The furnishing of this document does not give you license to these patents, trademarks, copyrights, or other intellectual property except as expressly provided in any written license agreement from 3M Touch Systems, Inc.

The information provided in this document is intended as a guide only. For the latest detailed engineering specifications, please contact your 3M Touch Systems, Inc. Application Engineer. 3M Touch Systems, Inc. is committed to continually improving product designs. As a result, product specifications may be subject to change without notification.

"RoHS compliant 2011/65/EU" means that the product or part does not contain any of the following substances in excess of the following maximum concentration values in any homogeneous material, unless the substance is in an application that is exempt under RoHS: (a) 0.1% (by weight) for lead, mercury, hexavalent chromium, polybrominated biphenyls or polybrominated diphenyl ethers; or (b) 0.01% (by weight) for cadmium. This information represents 3M's knowledge and belief, which may be based in whole or in part on information provided by third party suppliers to 3M.

NOTICE: Given the variety of factors that can affect the use and performance of a 3M Touch Systems, Inc. product (the "Product"), including that solid state equipment has operation characteristics different from electromechanical equipment, some of which factors are uniquely within User's knowledge and control, it is essential that User evaluate the 3M Touch Systems, Inc. Product and software to determine whether it is suitable for User's particular purpose and suitable for User's method of application. 3M Touch Systems, Inc. statements, engineering/technical information, and recommendations are provided for User's convenience, but their accuracy or completeness is not warranted. 3M Touch Systems, Inc. products and software are not specifically designed for use in medical devices as defined by United States federal law. 3M Touch Systems, Inc. products and software should not be used in such applications without 3M Touch Systems, Inc. express written consent. User should contact its sales representative if User's opportunity involves a medical device application.

IMPORTANT NOTICE TO PURCHASER: Specifications are subject to change without notice. These 3M Touch Systems, Inc. Products and software are warranted to meet their published specifications from the date of shipment and for the period stated in the specification. **3M Touch Systems, Inc. makes no additional warranties, express or implied, including but not limited to any implied warranties of merchantability or fitness for a particular purpose.** User is responsible for determining whether the 3M Touch Systems, Inc. Products and software are fit for User's particular purpose and suitable for its method of production, including intellectual property liability for User's application. If the Product, software or software media is proven not to have met 3M Touch Systems, Inc. warranty, then 3M Touch Systems, Inc. sole obligation and User's and Purchaser's **exclusive remedy**, will be, at 3M Touch Systems, Inc. option, to repair or replace that Product quantity or software media or to refund its purchase price. 3M Touch Systems, Inc. has no obligation under 3M Touch Systems, Inc. warranty for any Product, software or software media that has been modified or damaged through misuse, accident, neglect, or subsequent manufacturing operations or assemblies by anyone other than 3M Touch Systems, Inc. **3M Touch Systems, Inc. shall not be liable in any action against it in any way related to the Products or software for any loss or damages, whether non-specified direct, indirect, special, incidental or consequential (including downtime, loss of profits or goodwill) regardless of the legal theory asserted.**

© 3M 2001-2011 All rights reserved.

Document Title: *3M™ MicroTouch™ Controller EX USB Reference Guide*

Document Number: TSD-29489, Version F

3M, the 3M logo, MicroTouch, and the MicroTouch logo are either registered trademarks or trademarks of 3M in the United States and/or other countries.

Windows and/or other Microsoft products referenced herein are either registered trademarks or trademarks of Microsoft Corporation in the U.S. and/or other countries.

All other trademarks are the property of their respective owners.

Contents

Contents

Chapter 1

Introduction

What You Need to Know	5
Important Safety Information	5
Sensor Care and Cleaning	6
3M Touch Systems Support Services	7
Contact 3M Touch Systems	7

Chapter 2

Integrating the 3M™ MicroTouch™ EX USB Controllers

Overview of the EX USB Controllers.....	8
Handling and ESD Protection	9
Establishing the Data Connection	9
EX121/EX141 Sensor Connections	10
EX111 Sensor Connections.....	10
EX151 Sensor Connections.....	11
Mounting the Controller.....	12
Supplying Power to the Controller.....	12
Mounting the Sensor	12
Turning On Your System	12
Status Light (LED) Diagnostics	13
Installing 3M™ MicroTouch™ Software.....	14

Chapter 3

3M™ MicroTouch™ EX USB Controller Communications

Overview of USB Firmware Commands	15
Communicating with the Controller.....	16
Vendor Requests	16

Sending Commands to the Controller	17
Receiving Reports from the Controller	17
Coordinate Data Report 1.....	18
Calibration Request 4.....	19
Controller Status Request 6.....	20
Controller Status Report 6.....	21
Reset Request 7	23
Restore Defaults Request 8	24
Controller ID Request 10	25
Controller ID Report 12	25
Read Parameter Request 16	27
Parameter Data Report 4	28

Appendix A

EX121/EX141 Controller Specifications

EX121/EX141Dimensions	29
Technical Specifications	31
Physical Dimensions	31

Appendix B

EX111/EX151 Controller Specifications

Figure 3 EX111 Dimensions	33
Technical Specifications	36
Physical Dimensions	36

CHAPTER 1

Introduction

3M Touch Systems offers several advanced controllers designed for reliability and easy installation. Each controller provides superior performance and delivers excellent stability, sensitivity, accuracy, and fast response.

This reference guide, designed for developers of touch systems, provides installation and configuration information for the 3M™ MicroTouch™ EX USB capacitive touch controller. This document includes information on integrating the EX USB controller into your design, communicating with the controller, installing the MT 7 software user interface, and troubleshooting setup problems. It also includes a complete description of the firmware commands and controller specifications.

3M Touch Systems is committed to being a premier supplier in touch systems throughout the world. As a 3M Touch Systems customer, you are aware that we have strong internal programs that meet or exceed environmental regulations of our customers and the regions in which we conduct business.

What You Need to Know

This document assumes you are familiar with firmware commands and how to use them. Executing some commands may alter the performance of your touch product. You should be aware of the results of using these commands before executing them.

Important Safety Information

Read, understand and follow all safety information before using this product. Follow all instructions marked on the product and described in this document. Pay close attention to the following installation warnings and safety precautions.

Intended Use
The EX USB controller was designed to enable surface capacitive touch in conjunction with other 3M™ MicroTouch™ sensor products and was tested to replace an existing USB controller. This controller is not suitable for use in hazardous locations.

Explanation of Signal Word Consequences

⚠ WARNING: Indicates a potentially hazardous situation, which, if not avoided, could result in death or serious injury and/or property damage.

⚠ CAUTION: Indicates a potentially hazardous situation, which, if not avoided, may result in minor or moderate injury and/or property damage.

CAUTION: Indicates a potentially hazardous situation, which, if not avoided, may result in property damage.

⚠ WARNING

To reduce the risk of fire and/or explosion which could result in serious injury or death:

Do not install or use this product in a hazardous location.

To reduce the risk of fire and/or explosion which could result in serious injury or property damage:

Do not use this product in any outdoor environment unless NEMA standards (or similar standards such as IP rating) are followed.

To avoid the risk of electric shock which could result in serious injury or death:

- Do not use a damaged power supply.
- Do not use a power cord that is frayed or otherwise damaged.

⚠ CAUTION

To reduce the risks associated with improper disposal, which if not avoided may result in minor or moderate injury from ground water contamination:

Dispose of components in accordance with federal, state and local regulations.

To reduce the risk of possible environmental contamination which may result in minor or moderate injury:

Dispose of the display in accordance with federal, state and local regulations.

To reduce the risk of the potentially hazardous situations associated with the use of isopropyl alcohol which may result in minor or moderate injury or property damage:

Follow all instructions and recommendations in the manufacturer's Material Safety Data Sheet and product label.

Sensor Care and Cleaning

The sensor requires very little maintenance. 3M Touch Systems recommends that you periodically clean the glass surface.

Typically, an isopropyl alcohol and water solution ratio of 50:50 is the best cleaning agent for your touch screen. You can also use straight isopropyl alcohol. Be sure to follow solvent manufacturer's precautions and directions for use when using any solvents.

- It is important to avoid using any caustic chemicals on the sensor.

- Always dampen the cloth and then clean the screen. Be sure to spray the cleaning liquid onto the cloth, not the screen, so that drips do not seep inside the display or stain the bezel.
- Apply the cleaner with a soft, lint-free cloth. Avoid using gritty cloths.
- Always handle the sensor with care. Do not pull on or stress flex tail.

3M Touch Systems Support Services

3M Touch Systems provides extensive support services through our website and technical support organization. Visit the 3M Touch Systems website at <http://www.3M.com/touch>, where you can download touch software and drivers, obtain regularly updated technical documentation on 3M Touch Systems products, and learn more about our company.

Whenever you contact Technical Support, please provide the following information:

- Touch display size, part number and serial number
- Current driver version
- Operating system used
- Information on additional peripherals

Technical Support is available Monday through Friday 8:30 a.m. to 5:30 p.m. with limited call back service after 5:30 p.m. until 8:00 p.m. US Eastern Standard Time – 9 a.m. to 5 p.m. throughout Europe.

You can contact 3M Touch Systems Technical Support (US only -- Eastern Standard Time) by calling the hot line, sending email or a fax.

- Technical Support Hot Line: 978-659-9200
- Technical Support Fax: 978-659-9400
- Toll Free: 1-866-407-6666 (Option 3)
- Email: US-TS-techsupport@mmm.com

Contact 3M Touch Systems

Contact information for all offices can be found on our website at:

<http://www.3M.com/touch/>

CHAPTER 2

Integrating the 3M™ MicroTouch™ EX USB Controllers

The 3M™ MicroTouch™ EX USB controller provides a drop-in replacement for an existing controller with wide dynamic range, increased noise immunity, wide operating temperature stability, reprogrammability using software utilities and improved capability in ungrounded environments.

The firmware for the EX1N1 series USB controllers is optimized for surface capacitive sensors integrated in the latest displays.

This chapter covers the following EX controller specifications:

- Cable connections
- Mounting requirements
- Power requirements and options
- Status LED codes

Overview of the EX USB Controllers

Note: For complete specifications for each of these EX USB controllers, refer to the appendices at the end of this manual.

The EX II ASIC has a built-in Universal Serial Bus (USB) full speed interface. A full speed USB interface has a data rate of 12 Mb/s. The USB core in the ASIC was designed to USB specification revision 1.1 but is forward compatible with revision 2.0.

A 25-point linearization procedure has been performed to determine the physical properties of the sensor, and the data is stored in a 2D bar code label attached to the flex tail.

To integrate and test the EX USB controller, you need the following items:

- A 3M™ MicroTouch™ surface capacitive sensor (available in a variety of sizes).
- A method of establishing the USB data communication between the controller and your system. The standard 3M™ MicroTouch™ USB cable (P/N 7319420) is recommended for this device.
- The controller will operate with the standard USB +5V bus power.
- A touch driver and a calibration program. You can use 3M™ MicroTouch™ MT 7 software which includes the necessary touch driver and utilities software.

Handling and ESD Protection

When mounting the sensor and controller, use normal precautions for handling electrostatic sensitive devices. The EX USB controllers have internal protection to ± 27 kV for ESD discharges to the sensor (not to the controller directly) that may occur during normal operation of the sensor. Refer to the appendices for further specifications.

Establishing the Data Connection

The EX USB controller requires a 3M™ MicroTouch™ USB communication cable (P/N 7319420) or an equivalent interconnect. One end of this cable plugs into the USB connector (JP1) on the EX USB controller. The other end plugs into a USB port on your PC with a Type-A connector. Table 1 describes the interconnections of the 3M™ MicroTouch™ USB cable.

Table 1. USB Cable for EX USB Controllers

PC Side (USB Type A)		Wire	Controller Side (5-Pin Molex)	
Pin	USB Assigned	Color	Pin	Description
1	+5VDC	Red	1	+5VDC input power
2	Data (DN)	Gray	2	Data (DN) differential pair
3	Data (DP)	Green	3	Data (DP) differential pair
4	0V	Black	4	Power return
5	Cable Shield Shell	Charcoal Gray	5	Outer cable shield around signal and power lines. Chassis (earth) ground

EX121/EX141 Sensor Connections

The sensor cable has a 12-pin (2 x 6) dual row female connector that plugs into the controller. Table 2 describes the pins on this connector. The sensor connector always exits towards the USB cable.

Table 2. Sensor Cable Connector for EX121/EX141 Controllers

Pin	Wire Color	Description
1	———	NOVRAM interface
2	———	NOVRAM interface
3	———	NOVRAM interface
4	———	+5 VDC
5	Gray	Not used
6	Green	Chassis (earth) ground
7	Orange	Not used
8	Brown Cable shield/drain wire	Connects to the flex tail shield, which must not be grounded because the controller drives the flex tail shield with an AC waveform.
9	White	Upper right (UR) corner
10	Red	Lower right (LR) corner
11	Black	Upper left (UL) corner
12	Blue	Lower left (LL) corner

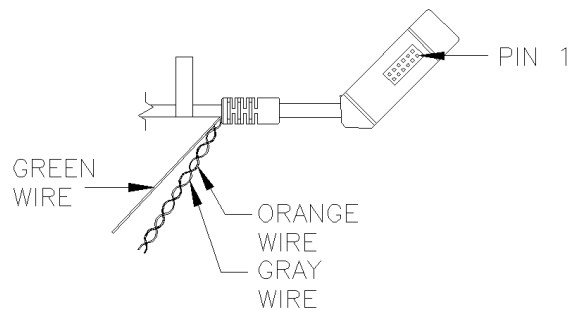

EX111 Sensor Connections

The sensor cable has a 5-pin single row locking female connector that plugs into the controller. Table 3 describes the pins on this connector.

Table 3. Sensor Flex Tail Connector for EX111 Controllers

Pin	Description
1	Upper left (UL) corner
2	Upper right (UR) corner
3	Connects to the flex tail shield, which must not be grounded because the controller drives the flex tail shield with an AC waveform.
4	Lower right (LR) corner
5	Lower left (LL) corner

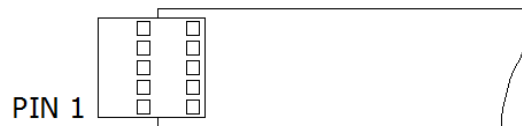

EX151 Sensor Connections

The sensor cable has a 5-pin ZIF connector that plugs into the controller. Table 4 describes the pins on this connector.

Table 4 Sensor Cable Connector for EX151 Controllers

Pin	Wire Color	Description
1		Upper left (UL) corner
2		Upper right (UR) corner
3	Cable shield/drain wire	Connects to the flex tail shield, which must <i>not</i> be grounded because the EX112 drives the flex tail shield with an AC waveform.
4		Lower right (LR) corner
5		Lower left (LL) corner

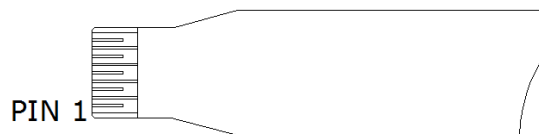

Mounting the Controller

The cased controller is mounted externally. The uncased controller is mounted internally. Choose a convenient spot away from high-voltage, high power cables and electronics. Use 4-40 plastic screws to mount the cased controller to eliminate possible ESD input path. Metal or plastic screws can be used on the 2x3 board if the green ground wire is used. Metal screws are required on the 1x2 board if a separate ground wire is not used.

The controller should be mounted in line with the sensor flex tail exit point to minimize flexing. Refer to Figure 1 for more details on controller mounting.

Supplying Power to the Controller

The controller is designed to use USB bus power (that is, tap power from the USB port). The source must deliver 75 mA typical -- 100 mA maximum, with a maximum ripple and noise of 50mV peak-to-peak.



CAUTION

To avoid possible damage to the controller, you must provide a path for electrostatic discharge. The controller-mounting hole near the sensor connector should be used to connect to chassis safety ground and must be attached by the shortest possible route to a good earth return (chassis) in all applications.

Mounting the Sensor

There are several methods for mounting the sensor depending on your application. If you need instructions or recommendations from 3M Touch Systems on how to incorporate a sensor into your design, refer to the *3M™ MicroTouch™ System 3250EX Integration Guide* (P/N 19-278). All 3M Touch Systems documentation is available from the corporate website at www.3Mtouch.com.

Turning On Your System

Before you turn on your custom system, ensure that all cables are connected properly and that the controller is properly mounted.

To start up your system:

1. Turn on your display and computer.
2. Adjust the contrast and brightness to suit your personal preference and working environment.
3. Adjust the horizontal and vertical position controls on the display to center the image on the sensor.

If the driver has been previously loaded, the controller will enumerate when hot plugging the controller into a USB port.

Status Light (LED) Diagnostics

3M™ MicroTouch™ controllers are highly reliable units; however, there may be occasions when the controller does not perform exactly as you expected. The EX USB controller provides diagnostic feedback with a light emitting diode (LED) on the component side of the board that indicates the status of the touch system.

If the LED is on, and remains dimly lit, the controller has power and is operating properly. If the LED is off, the controller is not receiving power or USB communications have stopped and the controller is in suspend mode.

The LED indicator also provides visual indication of the controller's internal self-tests by flashing or blinking a code that may be interpreted using the table below. The test results are also returned as part of the USB Status report. Those bits that result in a flashing error code are repeated in the table below.

Some errors are fatal -- that is, normal sensor operation cannot occur. Others errors may simply cause "default conditions" to be assumed and sensor operation may proceed.

Table 4. LED Diagnostic Codes for EX USB Controllers

Self Test Condition	LED Flashes	Self Test Bit	Description	What to do...
RAM Data Error ²	1	0	Data side checksum error	Reload program code.
RAM Code Error ²	2	1	Firmware EEPROM checksum verification error	Reload program code.
STRAY Error ¹	3	2	Unable to initialize stray cancellation	Replace controller. If error reoccurs, might be a sensor problem.
NOV Error ³	4	3	Parameters invalid (using defaults)	Restore defaults. If fault persists, replace controller. If error reoccurs, might be a sensor or cable problem.
HDW Error ¹	5	4	Controller hardware failure (phase/gain initialization)	Cycle power. If fault persists, replace controller.
Reserved	6	5	Reserved	
CABLE Error	7	6	Cable NOVRAM linearization data invalid	At startup, the cable NOVRAM error will flash the LED until the controller receives a status command from host.
NOV2 Error	8	7	Controller NOVRAM linearization data invalid	Replace sensor or perform a 25-point linearization. Contact Technical Support.
Reserved	9	8	Reserved	
EEPROM Error ²	10	9	EEPROM is not working	Reload program code.

Self Test Condition	LED Flashes	Self Test Bit	Description	What to do...
NOV5 Error	11	10	Controller ID is not valid	Restore defaults. If fault persists, replace controller.
NOV6 Error	12	11	Interface configuration values are not valid	Restore defaults. If fault persists, replace controller.
NOV7 Error	13	12	Touch configuration values are not valid	Restore defaults. If fault persists, replace controller.
Reserved	14	13	Reserved	
Resistance Error	15	14	Sensor resistance is out of supported range	Cycle power. If fault persists, replace sensor.
Backplane Error	16	15	Low resistance path from backplane to sensor	Cycle power. If fault persists, replace sensor.
Corner Error	17	16	Corner drive offset level is too high	Cycle power. If fault persists, replace controller.
Fixed Cal Error	18	17	Fixed 2-point cal error high	Cycle power. If fault persists, replace controller.

Note 1: this is a fatal error.

Note 2: this error is detected by the ROM code

Note 3: indicates that the EEPROM is not formatted when given by the ROM code

Installing 3M™ MicroTouch™ Software

3M™ MicroTouch™ Software includes the driver that enables your sensor to work with your computer. 3M Touch Systems has touch drivers for many operating systems, including Windows® 7, Windows® Vista, Windows® XP, Windows® XP embedded, Windows® CE, and Linux® (Kernel 2.6) (refer to the website for a complete listing). You must be sure to install the correct software for your operating system.

3M™ MicroTouch™ Software includes a control panel for setting your sensor preferences and a diagnostic utility. If you are experiencing problems with the sensor, you can use the diagnostic utilities provided to locate the controller and test the sensor.

For more information on connecting your cables and installing and using the sensor control panel and utilities, refer to the 3M™ MicroTouch™ Software User Guides available on the corporate website at www.3Mtouch.com.

CHAPTER 3

3M™ MicroTouch™ EX USB Controller Communications

This chapter discusses the fundamentals of communicating with the 3M™ MicroTouch™ EX USB controller. The firmware commands, which are usually issued by a driver or utility program on the host system, control the operation of the touch controller, however developers can enter these commands directly. This chapter:

- Describes the controller default settings.
- Lists the recommended firmware commands for current development.
- Describes how to use each of these commands.
- References additional commands developers may need to use.

The description of each command includes the command syntax, the default value, how the command works, and the expected response from the controller.

Note: HID versions of these controllers are available. Please consult your sales representative for details.

Overview of USB Firmware Commands

Developers may use these USB commands when writing touch applications, developing custom drivers or touch configurations, or testing their touch systems. Developers can issue commands to initialize the controller, select operating modes, and execute diagnostic functions.

Most sensor users do *not* have to use firmware commands to use their touch systems. For example, users can use MT 7 software to calibrate the sensor or to determine the controller type and firmware version.

Note: This document assumes you are familiar with USB standards and modes of communication with USB devices, as well as firmware commands and how to use them. Executing some commands may alter the performance of your sensor and render it inoperable. You should be aware of the results before executing any firmware commands.

To optimize the performance of the 3M™ MicroTouch™ EX USB touch controller and simplify the development of custom drivers, 3M Touch Systems recommends you use the commands listed in this chapter for current development. Using these commands ensures compatibility with all 3M™ MicroTouch™ controllers.

Communicating with the Controller

This section provides information on sending firmware commands to the controller and interpreting the responses that the controller returns. The default operation of the EX USB controller is USB Rev 1.1 compliant.

The USB command set is implemented by using vendor requests and vendor reports, i.e., vendor specific transactions.

You need to know product ID (1 for normal mode and 2 for special mode) and the vendor ID (0596H) to write your own driver.

The EX USB controller is command set compatible with previous generation MicroTouch™ USB controllers. Modifications of existing software should not be necessary when replacing an older controller.

The following commands are those that 3M Touch Systems currently uses for communications. 3M Touch Systems recommends that you use only these commands for 3M™ MicroTouch™ EX USB controller communications.

Vendor Requests

The following list summarizes the six available vendor requests:

- Request 4 Calibrate
- Request 6 Status
- Request 7 Reset
- Request 8 Restore Defaults
- Request 10 Controller ID
- Request 16 Read Parameter

Sending Commands to the Controller

Table 5. General Format for Vendor Requests

Offset	Field	Size	Value	Description
0	bmRequestType	1	d1000000	Characteristics of request [dir, type, recipient] D7: Data Transfer Direction 0 = Host-to-device 1 = Device-to-host D6... 5 Type 0 = Standard 1 = Class 2 = Vendor 3 = Reserved D4...0 Recipient 0 = Device 1 = Interface 2 = Endpoint 3 = Other 4...31 = Reserved
1	bRequest	1	0xXX	Specific request [our command number]
2	wValue	2	0xFFFF	Used to specify command parameters
4	wIndex	2	0xFFFF	Used to specify command parameters
6	wLength	2	0xFFFF	Number of bytes to transfer

The Type field should be set to Vendor (0x10). The Recipient field should be set to Device. The Direction field depends on the command.

Receiving Reports from the Controller

Four reports can be sent from the controller to the host. These reports fit into two categories: those sent immediately in response to a host request (synchronous) and those sent when updates to the data they contain become available (asynchronous).

Synchronous reports:

- Report 4 Parameter Data
- Report 6 Status
- Report 12 Controller ID

Asynchronous reports:

- Report 1 Coordinate Data

Some possible reasons for a command failure include:

- The command was not formatted correctly.
- The system parameters were not set up to allow command execution.
- The controller does not support the command.

Controller Initialization

To initialize the EX USB controller, 3M Touch Systems recommends that the host system issue a Reset command whenever the host system is powered on and is attempting to establish communication with the controller.

Coordinate Data Report 1

Coordinate Data Report 1 is used to transfer both the raw and adjusted coordinate data to the host. This report, when activated, is sent to the host whenever new data is available. It is an asynchronous report activated by default at power up.

Table 6. Coordinate Data Report

Offset	Field	Size	Value	Description
0	Report ID	1	0x01	USB report ID number
1	Loop Counter	1	0xXX	Report synchronization
2	Status byte	1	0xXX	Pen/finger touch status
3	X Compensated	2	0xFFFF	Compensated X coordinate
5	Y Compensated	2	0xFFFF	Compensated Y coordinate
7	X Raw	2	0xFFFF	Raw X coordinate
9	Y Raw	2	0xFFFF	Raw Y coordinate

The main purpose of the loop counter is to effectively put a time stamp on the output data. Data produced in the same tick will have the same timestamp. This can be used to match the final coordinate data with other data that was used to produce it. This is not a sequential number.

The status byte contains information pertaining to whether the sensor is being touched.

Table 7. Touch Status

Bit	Description
7	Always 1
6	Proximity 1 when touching 0 when not touching
5	Reserved
4	Reserved
3	Reserved
2	Reserved
1	Reserved
0	Reserved

The raw X and Y coordinate data are generated directly from the sensor. The range of values is -8192 to 8191. The X and Y adjusted coordinate data is derived by applying calibration information. The range of values is 0 to 65,535. Coordinate data is sent LSB first.

Operating Mode

The operating mode specifies the conditions under which the controller sends the X and Y touch coordinates (input data packet) to the host system.

Report 1 enabled is the default operating mode for the EX USB controller. In Report 1, the controller sends a continuous stream of data packets when the sensor is touched. The controller sends the data as long as a touch continues on the sensor.

Because Report 1 sends touch data continually, it is the most versatile mode, and it provides the best response time and overall feel.

3M Touch Systems recommends that the touch driver generate an event as each packet in the data stream arrives. Because touchdown and liftoff events are specially coded, your software can generate mouse events that correspond to what the user is doing.

Calibration Request 4

This is a request to perform a 2-point calibration. The calibration can be performed at points inset from the lower left and upper right corners (extended calibration) or it can be done at those corners. This is equivalent to the Calibrate Extended (12.5% insets from the lower left and upper right corners) command used by 3M™ MicroTouch™ serial controllers. The 2-point calibration defines the active area of the sensor by mapping two targets displayed on the video image to absolute X and Y coordinates on the sensor.

Table 8. Calibration Request

Offset	Field	Size	Value	Description
0	bmRequestType	1	01000000	Characteristics
1	bRequest	1	4	Command number
2	wValue	2	0xXXXX	Calibration type
4	wIndex	2	0x0000	Not used
6	wLength	2	0	No data phase

The direction bit in bmRequestType has been set to 0 (host-to-device). This request does not require that the device return any data. The byte bRequest is set to 4 to indicate that this is the calibration command.

The wValue field is used to select the type of calibration to be performed. This value can be either 1 for Extended (or Inset) or 2 for Corner.

The controller does not use the wIndex field. This field should be set to zero to ensure future compatibility.

Response

The device stalls endpoint 0 if the request cannot be processed successfully. The host should issue status requests to determine the status of this request. A command status of 1 indicates that the controller is waiting for a touch in the lower left quadrant. A status of 2 indicates that the lower left touch has been completed and the controller is waiting for a touch in the upper right quadrant. A status of 3 indicates that the upper right touch has been completed. A status of 0 indicates that the request has failed. A soft reset command should be sent if the host wishes to terminate calibration.

Determining Target Areas

The default calibration targets (points) are located 12.5% (1/8) inward from the corners of the video image. For example, suppose the resolution of your Windows-based display is 1024 x 768. The Calibrate Extended command calculates the amount to move inward as follows:

- Amount to move inward in the X direction: $1024 \times 1/8 = 128$
- Amount to move inward in the Y direction: $768 \times 1/8 = 96$

The Calibrate Extended command then positions the first calibration target inward from the lower left corner (0,767) and the second calibration target inward from the upper right corner (1023,0). The following illustration shows how the calibration targets are calculated for a Windows-based system. Your operating system may be different.

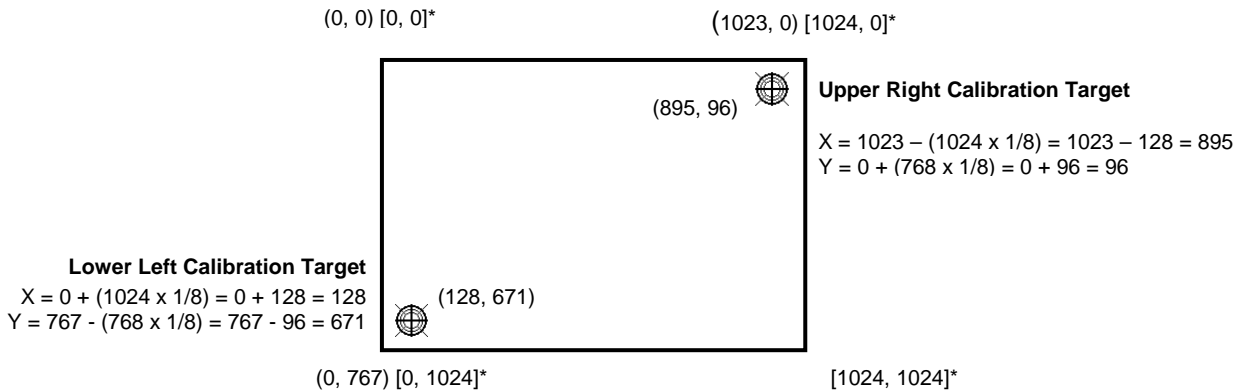

*The coordinates are in *video* terms, with the origin (0, 0) in the upper left corner of the sensor. Examples from the *controller's* perspective, however, place the origin at the lower left corner of the sensor (numbers in brackets). The controller outputs 0 to 64K on both axes independent of display screen resolution.

Controller Status Request 6

This is a request to send information that indicates the status of the controller. Use this request to determine whether there were any power on check errors and whether the last request was completed successfully.

The Controller Status Request is used to poll the controller for command completion when a previous USB request involved a controller reset. Refer to the Reset Request 7 for additional details.

Table 9. Controller Status Request

Offset	Field	Size	Value	Description
0	bmRequestType	1	11000000	Characteristics
1	bRequest	1	6	Command number
2	wValue	2	0x0000	Not used
4	wIndex	2	0x0000	Not used
6	wLength	2	0xXXXX	Size of status report

The direction bit in bmRequestType has been set to 1 (device-to-host) to return the status report.

The byte bRequest is set to 6 to indicate that this is a Controller Status request.

The controller does not use the wValue and wIndex fields. These fields should be set to zero to ensure future compatibility.

The wLength field indicates the size of the Controller Status report.

Response

When the request is processed, the device returns a Controller Status report.

The device stalls endpoint 0 if the request cannot be processed successfully. This would happen if the report length requested by wLength does not match the controller status report size.

Controller Status Report 6

This report contains information describing the status of the controller. The report sent is determined by the size specified in the wLength field of the Status Request.

All multi-byte quantities in this report are sent LSB first.

Standard Format Status Report

This version of the Status report will be sent if the EX compatible driver asks for the 8-byte Status report. This version is simply the first 8 bytes of the controller Status report.

EX Controller Status Report

This version of the Status report is only compatible with the EX USB controller. This version is sent when the larger (20-byte) Status report is requested.

Table 10. Expanded Status Report

Offset	Field	Size	Value	Description
0	Report ID	1	0x06	Report ID number

Offset	Field	Size	Value	Description
1	POC Status	2	0XXXXX	Power On Check Status
3	Cmd Status	1	0XX	Status of last command
4	Touch Status	1	0XX	Finger Up/Down
5	Asynch Reports	2	0XXXXX	Active asynchronous reports
7	Reserved	2	0XXXXX	Reserved
9	Extended POC Status	2	0XXXXX	Additional Power On Check Status
11	Reserved	9	9 bytes	Reserved

POC Status – The status of the Power On Checks. Various controller systems are checked at power-up. If any failures in these systems are detected, a POC flag is set. The POC status field reports the state of these flags. The POC status information is also flashed on the controller’s LED. The number of flashes generated for a given error is one more than the error’s bit number. Refer to Table 3 for further details. This is a 2-byte bitmapped field.

Note: Issuing a Status Request will suppress displaying the cable NOVRAM error (bit 6) on the LED. Even though the error is suppressed, it will continue to flash on the LED until the sensor is touched.

Cmd Status – The status for the last command request. This field is used to determine whether the last request was processed successfully. It is also used to track the progress of a multi-stage request, such as 2-point calibration. The Status Request does not affect the contents of this field, i.e., successful or unsuccessful processing of a previous status request does not cause the command status field to be updated.

Table 11. Valid Command Status Field Entries

Response	Description
0	Failure in command processing
1	Command being processed
2	Stage 1 processing complete (for multi-stage commands)
3	Command complete
4	Soft reset occurred
5	Hard reset occurred

Touch Status – Status information for the most recent touch coordinate.

Table 12. Touch Status

Bit Number	Description
0	1 if the sensor is being touched
1 - 7	Reserved

Asynch reports – the only active asynchronous report is the Touch Coordinate report 1.

Extended POC Status – This is additional power on status information. This is a 2-byte bitmapped field.

Table 13. Extended POC Status

Bit Number	Description
0	Corner drive offset level is too high
1	Fixed 2-point calibration error high
2 - 15	Reserved

Reset Request 7

This is a request to perform a controller reset. The standard hard or soft reset can be requested. Soft resets are generally required for any parameter changes to take effect. A soft reset results in the touch application using its initial (start-up) values.

Table 14. Reset Request

Offset	Field	Size	Value	Description
0	bmRequestType	1	01000000	Characteristics
1	bRequest	1	7	Command number
2	wValue	2	0xXXXX	Reset type
4	wIndex	2	0x0000	Not used
6	wLength	2	0x0000	No data phase

The direction bit in bmRequestType has been set to 0 (host-to-device).

The byte bRequest is set to 7 to indicate that this is a Reset request.

The wValue field is used to select the type of reset to be performed -- 1 for Soft Reset and 2 for Hard Reset.

The wIndex field is not used. This field should be set to zero to ensure future compatibility.

The wLength field is set to zero since there is no data phase for this request.

Response

Since the time to complete the soft reset can be more than 500 ms, the device acknowledges the request before it is completed. The host must issue a status request to determine whether the reset request was completed. The command status field of the status report will be set to “command in progress” while the soft reset is occurring. The field will change to “soft reset occurred” when the reset has completed. Any other request issued while the reset is still in progress will be ignored.

The hard reset is executed immediately upon decoding of this request. The reset sequence begins by simulating a device disconnect from the host. A re-connect is then performed and the device must re-enumerate its connection with the host. Because of this, a response to the request cannot be sent prior to, or even after, the beginning of the reset sequence.

The host should issue status and ID requests after the reset has completed to verify whether this request was handled properly by the device. The status request should be used to determine when the hard reset occurred. The ID request is used to verify that the controller is now in the desired mode by looking at the contents of the controller type field.

The device stalls endpoint 0 if the request cannot be processed successfully. The request cannot be processed if the reset type specified by the wValue field is not valid.

EX Controller Compatibility Issues

The hard reset did not use a device disconnect as part of the reset process for the previous 3M™ MicroTouch™ USB controller. The disconnect causes the driver to unload and will result in any handles to the driver that an application may have becoming invalid. An application should handle an unplug event.

Restore Defaults Request 8

This is a request to restore the default values in the controller. This is used to restore the values to the factory presets.

A soft reset is automatically done after completing the request so that parameter changes will take effect.

Table 15. Restore Defaults Request

Offset	Field	Size	Value	Description
0	bmRequestType	1	01000000	Characteristics
1	bRequest	1	8	Command number
2	wValue	2	0x0000	Reserved
4	wIndex	2	0x0000	Reserved
6	wLength	2	0x0000	No data phase

The direction bit in bmRequestType has been set to 0 (host-to-device). This request does not require that the device return any data.

The byte bRequest is set to 8 to indicate that this is the Restore Defaults request.

The wValue field should be set to 0 for future compatibility.

The wIndex field should be set to 0 for future compatibility.

Response

The device stalls endpoint zero if it cannot process this request. The request will fail if any of the fields are not set correctly.

When the request is processed successfully, a positive USB acknowledge (zero length data packet) is sent.

A soft reset will be done at the completion of this request. Because of this, the controller must be polled to determine when the reset is done (see Reset Request for details).

Controller ID Request 10

This is a request to send various pieces of information that identify the controller, including the controller type and firmware revision level. The key use for this request is in identifying the mode that the controller is running in and the revision level of the ASIC firmware.

Table 16. Controller ID Request

Offset	Field	Size	Value	Description
0	bmRequestType	1	11000000	Characteristics
1	bRequest	1	10	Command number
2	wValue	2	0x0000	Not used
4	wIndex	2	0x0000	Not used
6	wLength	2	0xFFFF	Length of ID report

The direction bit in bmRequestType has been set to 1 (device-to-host) to return the Controller ID report.

The byte bRequest is set to 10 to indicate that this is Controller ID request.

This request does not use the wValue or wIndex fields. These fields should be set to zero to ensure future compatibility.

The wLength field is set to the size (either 18 or 24 bytes) of a Controller ID report.

Response

The controller sends the Controller ID report when the request is processed successfully.

If the request cannot be processed, endpoint 0 will be stalled. The request cannot be processed if the requested report size (wLength) does not match either the size of the backward compatible ID report (18) or the EX report (24).

Controller ID Report 12

This report contains information describing the controller, including its type, firmware revision, special features, and the ROM checksum. This report is sent via the control endpoint.

All multi-byte quantities in this report are sent LSB first.

Standard Format Controller ID Report

This version of the Controller ID report will be sent if the EX compatible driver asks for the 16-byte Controller ID report size. This version contains the first 16 bytes of the EX Controller ID report.

EX Controller ID Report

This version of the Controller ID report is only compatible with the EX USB driver. This version is sent when the larger (24-byte) Controller ID report is requested.

Table 17. Expanded Controller ID Report

Offset	Field	Size	Value	Description
0	Report ID	1	0x0C	Report ID number
1	Controller type	2	0xXXXX	Indicates the type of controller
3	FW major revision	1	0xXX	Firmware major revision level
4	FW minor revision	1	0xXX	Firmware minor revision level
5	Features	1	0xXX	Special features
6	Constants Checksum	2	0xXXXX	RAM constants checksum
8	Max Param Write	2	0xFFFF	Maximum data for Read Parameter request
10	Reserved	1	0x41	Reserved
11	Reserved	1	0x41	Reserved
12	Reserved	1	0x41	Reserved
13	Reserved	1	0x41	Reserved
14	Reserved	1	0x41	Reserved
15	Reserved	1	0x42	Reserved
16	Reserved	1	0x41	Reserved
17	Reserved	1	0x41	Reserved
18	Code Checksum	4	0XXXXXXXXX	RAM Program Code checksum
22	ASIC type	2	0x01XX	ASIC type

Controller Type – The identifier M1 is used. M identifies it as an EX based USB controller. The 1 identifies it as the first model of this type. This value is treated as an integer, not two characters. This means that the 1 will be transmitted first.

Note: If you received an identifier of M0, you must issue a Reset with a wValue of 5. This must be done twice to lock in the values.

FW Major Revision – This can range from 0 to 99. This is a BCD value, i.e., major revision 23 is sent as 0x23.

FW Minor Revision – This can range from 0 to 99. This is a BCD value, i.e., minor revision 23 is sent as 0x23.

Features – This identifies the special features of the controller. This is a bitmapped field.

Constants Checksum – 2-byte checksum for the constants data section.

Max Parameter Write -- The largest transfer that can take place. This only affects the Read Parameter requests.

Code Checksum – 4-byte checksum for the program section of the code.

ASIC Type – this indicates the type and version of the ASIC in the controller. The value 0x0100 indicates the first EX revision. The high byte is used to note major ASIC changes, such as a new ASIC family, and the low byte indicates changes within a family.

Read Parameter Request 16

This is a request to send the contents of a parameter via the control endpoint. This is a one-time transfer of data. The request is used to access data in the controller.

This request provides a means for reading the configuration parameters. The request uses parameter numbers to determine what data is being requested and where that data is located.

Table 18. Read Parameter Request

Offset	Field	Size	Value	Description
0	bmRequestType	1	11000000	Characteristics
1	bRequest	1	16	Command number
2	wValue	2	0xXXXX	Parameter number
4	wIndex	2	0x0000	Not used
6	wLength	2	0xXXXX	Length of Parameter Data report

The direction bit in bmRequestType has been set to 1 (device-to-host) to return the contents of the requested parameter.

The byte bRequest is set to 16 to indicate that this is the Read Parameter request.

The wValue field is set to the number of the parameter being requested.

This request does not use the wIndex field. This field should be set to zero to ensure future compatibility.

The wLength field is the number of bytes being sent by the device to the host. The data is returned to the host in the format of the Parameter Data report, which has a 3-byte header, so 3 must be added to the number of parameter bytes desired. The following table lists the parameters currently supported and the appropriate settings for the request fields.

Table 19. Supported Parameters

Parameter (wValue)	wIndex	wLength (bytes+3)	Range	Description
0	0	0	0	Reserved for future use
1	0	5	0 – 3	Sensor orientation - where the lower left corner of the display maps to the sensor.

				0000 – Upper right
				0001 – Lower right
				0002 – Upper left
				0003 – Lower left (standard, not rotated)
2	0	7	$0 - 2^{32}-1$	Controller serial number

Response

The parameter data is sent to the host in a Parameter Data report. All parameter data is treated as if it were stored as bytes. This means that multi-byte values will be sent MSB first.

If the command cannot be processed, the device stalls endpoint 0. The command cannot be processed if the parameter number is not valid. It cannot be processed if less than 4 bytes (wLength) are requested. It cannot be processed if more data is requested than is contained in the parameter.

Parameter Data Report 4

This report is sent in response to any request for parameter data. All parameter data is treated as if it were stored as bytes in the order that it is stored in memory. This means that multi-byte values will be sent MSB first.

Table 20. Parameter Data Report

Offset	Field	Size	Value	Description
0	Report ID	1	0x04	Report ID number
1	Data size	2	0XXXXX	Amount of data to follow
3	Data bytes	Data Size	0XXX	Data bytes

Data size – the number of data bytes to follow.

Data byte – At least 1 data byte will follow when data size is greater than zero. The number of data bytes returned by this report is limited by the “Max Param Write” value returned by the Controller ID report. The contents of this data section are dependent on which parameter is being accessed.

APPENDIX A

EX121/EX141 Controller Specifications

This section provides controller specifications such as power requirements, environmental requirements, and cable connectors.

The EX121/EX141 controller is a compact (3.5 x 2.25 x 0.3 inches), USB controller. This controller can be internally mounted in your display, or enclosed in a molded plastic case (3.75 x 2.5 x 0.9 inches) and mounted to the back or side of your display.

EX121/EX141 Dimensions

The controller has a NOVRAM sensor connector and a USB cable connector and comes in two varieties:

1. The cased version measures 2.5 x 3.75 inches with a total height of approximately 1-inch with the sensor cable attached. The cased version comes with a Type-A USB cable.
2. The uncased version measures 2.25 x 3.6 inches with a total height profile of 0.5-inch from the thru hole pins on the trace side of the board to the top of the highest component on the opposite side.

The following figures show the overall dimensions of the EX121/EX141 controller and the locations of the mounting holes and connectors.

Figure 1 EX121 Dimensions



Figure 2 EX141 Dimensions



Technical Specifications

The controller specifications listed below were validated in test systems containing 3M Touch Systems components. These specifications may not be valid if configured with components from suppliers other than 3M Touch Systems. All components in the manufacture of electronic controllers are RoHS Directive compliant (2011/65/EU).

Physical Dimensions

Uncased	3.50 in. x 2.30 in. x 0.45 in.	(88.9 mm x 58.4 mm x 11.4 mm)
Cased	3.75 in. x 2.50 in. x 0.90 in.	(95.3 mm x 63.5 mm x 22.9 mm)

Board Level Functions

Power	5 VDC (87 mA typical, 100 mA maximum); ± 5% regulation 50 mV _{pp} maximum ripple and noise
-------	---

Regulatory Requirements

CE		Compliant
Radiated Emissions – EN 55022:1998	Class B	Compliant
AC Mains Conducted Emissions – EN 55022:1998	Class B	Compliant
Telco Lines Conducted Emissions	N/A	N/A
RFI – EN 61000-4-3 / ENV 50140	Class A	Compliant
CRFI – EN 61000-4-6	N/A	Cable < 3 meters long N/A
	Class A	< 80% Screen Area
	Class B	≥ 80% Screen Area
EFT (Burst Immunity) – EN 61000-4-4	Class B	Compliant
ESD Susceptibility – IEC 61000-4-2	Class 1	Compliant
Surge – EN 61000-4-5	Class B	Compliant
Harmonics – EN 61000-3-2	Class A	Compliant
Flicker – EN 61000-3-3		Compliant
Power Frequency Magnetic Field – EN 61000-4-8	N/A	N/A
Voltage Dips – EN 61000-4-11	Class B	< 5% V
	Class C	< 70% V
Voltage Interruptions – EN 61000-4-11	Class C	Compliant
FCC Class B / CISPR22 Class B	Class B	Compliant
VCCI Class B ITE Emissions (Japan)	Class B	Compliant
AS/NZS 3548:1995/CISPR 22 Class B ITE Emissions (Aus.)	Class B	Compliant
UL/cUL		Compliant

Ambient Operating and Storage Environmental Conditions

Note: All humidity is non-condensing

Operating Temperature Range		-40 °C to +70 °C
Operating Humidity Range	< 36° C 0-90% RH	≥ 36 °C (refer to Figure 4)
Storage Temperature Range		-50 °C to +85 °C
Storage Humidity Range	< 36°C 0-90% RH	≥ 36 °C (refer to Figure 4)

Performance and Reliability

Minimum Touch Duration		Typically 5.4 msec.
Touch Resolution – (Maximum addressable coordinates generated by the controller)		16K x 16K
ESD Susceptibility ¹ -		
±8 kV Contact Discharge – Class 2 per section 9 of IEC 61000-4-2		Compliant
1 false touch allowed		
±27 kV Air Discharge – Class 1 per section 9 of IEC 61000-4-2		Compliant
Normal Operation – No false touches		
MTBF (by MIL Std. 217F Calculation)		500,000 Hours

Touch System Parameters

Accuracy vs. Dynamic Temperature Change (Tested at 0 deg. C to 60 deg. C with a 0.5 deg. C/minute temperature ramp)		Maintains 99.0% Accuracy
Sensor Compatibility Sensors		3M™ MicroTouch™ Surface Capacitive
Communications Protocol		USB

¹ ESD discharges to a 3M Touch Systems sensor connected to the controller

APPENDIX B

EX111/EX151 Controller Specifications

This section provides controller specifications such as power requirements, environmental requirements, and cable connectors. The EX111/EX151 controller is a compact USB controller. This controller can be internally mounted in your display.

The following figures show the overall dimensions of the EX111/EX151 controller and the locations of the mounting holes and connectors.

The EX111/EX151 has a sensor connector (JP2) and a USB cable connector (JP1) as shown below. The uncased controller measures approximately 1.3 x 2.6 inches with a total height of approximately 0.38-inch from the thru hole pins on the trace side of the board to the top of the highest component on the opposite side.

Figure 3 EX111 Dimensions

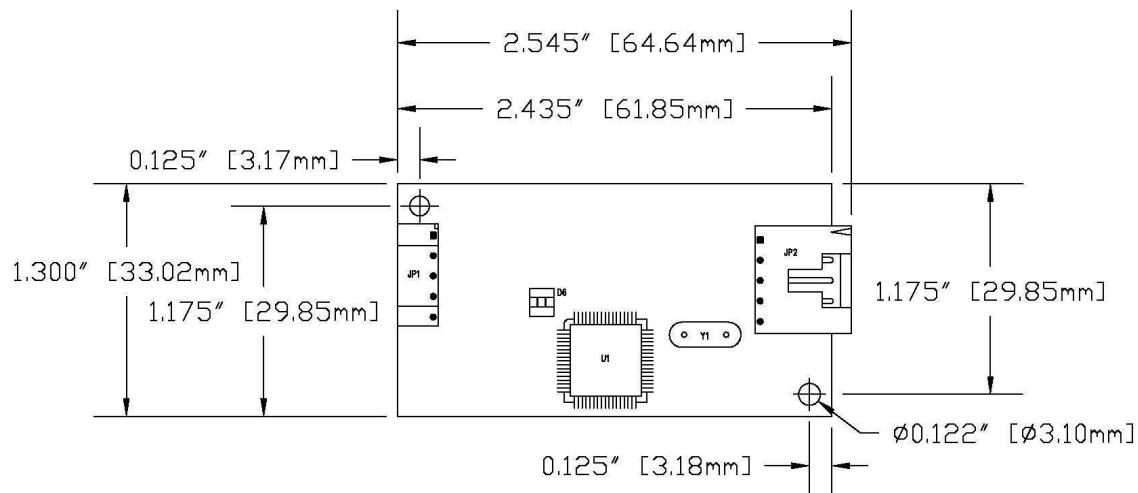
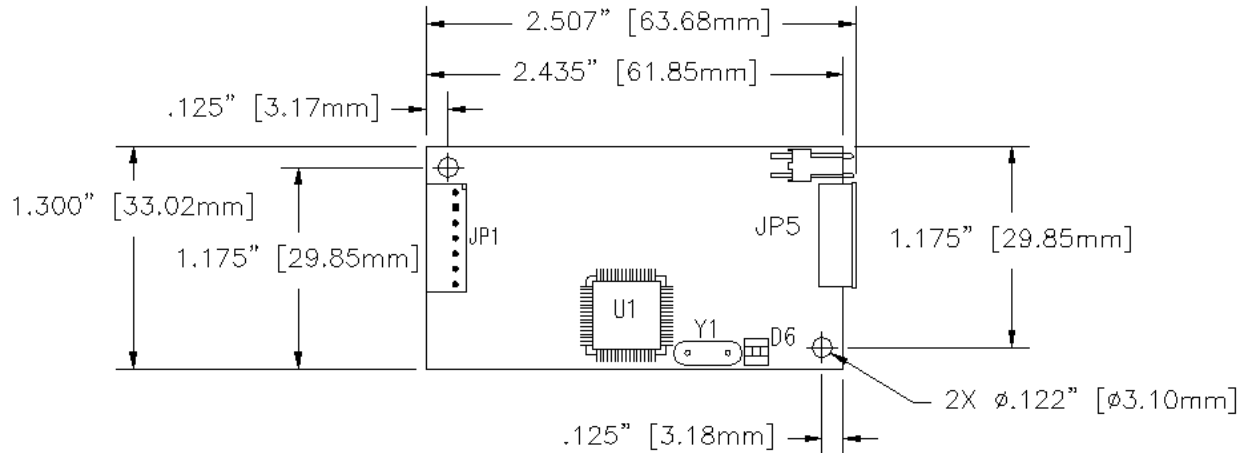

Figure 4 EX151 Dimensions

Technical Specifications

The controller specifications listed below were validated in test systems containing 3M Touch Systems components. These specifications may not be valid if configured with components from suppliers other than 3M Touch Systems. All components in the manufacture of electronic controllers are RoHS Directive compliant (2011/65/EU).

Physical Dimensions

2.55 in. x 1.30 in. x 0.45 in. (65.0 mm x 33.0 mm x 11.4 mm)

Board Level Functions

Power 5 VDC (75 mA typical, 100 mA maximum); $\pm 5\%$ regulation
50 mV_{pp} maximum ripple and noise

Regulatory Requirements

CE			Compliant
Radiated Emissions – EN 55022:1998	Class B		Compliant
AC Mains Conducted Emissions – EN 55022:1998	Class B		Compliant
Telco Lines Conducted Emissions	N/A		N/A
RFI – EN 61000-4-3 / ENV 50140	Class A		Compliant
CRFI – EN 61000-4-6	N/A	Cable < 3 meters long	N/A
	Class A	< 80% Screen Area	
	Class B	$\geq 80\%$ Screen Area	

EFT (Burst Immunity) – EN 61000-4-4	Class B		Compliant
ESD Susceptibility – IEC 61000-4-2	Class 1		Compliant
Surge – EN 61000-4-5	Class B		Compliant
Harmonics – EN 61000-3-2	Class A		Compliant
Flicker – EN 61000-3-3			Compliant
Power Frequency Magnetic Field – EN 61000-4-8	N/A	N/A	
Voltage Dips – EN 61000-4-11	Class B	< 5% V	
	Class C	< 70% V	Compliant
Voltage Interruptions – EN 61000-4-11	Class C		Compliant
FCC Class B / CISPR22 Class B	Class B		Compliant
VCCI Class B ITE Emissions (Japan)	Class B		Compliant
AS/NZS 3548:1995/CISPR 22 Class B ITE Emissions (Aus.)	Class B		Compliant
UL/cUL			Compliant

Ambient Operating and Storage Environmental Conditions

Note: All humidity is non-condensing

Operating Temperature Range		-40 °C to +70 °C
Operating Humidity Range	<36° C 0-90% RH	≥ 36 °C (refer to Figure 4)
Storage Temperature Range		- 50 °C to +85 °C
Storage Humidity Range	< 36°C 0-90% RH	≥ 36 °C (refer to Figure 4)

Performance and Reliability

Minimum Touch Duration	Typically 5.4 msec.
Touch Resolution – (Maximum addressable coordinates generated by the controller)	16K x 16K

ESD Susceptibility¹ -

¹ ESD discharges to a 3M Touch Systems sensor connected to the controller

±8 kV Contact Discharge – Class 2 per section 9 of IEC 61000-4-2 1 false touch allowed	Compliant
±27 kV Air Discharge – Class 1 per section 9 of IEC 61000-4-2 Normal Operation – No false touches	Compliant
MTBF (by MIL Std. 217F Calculation)	760,000 Hours

Touch System Parameters

Accuracy vs. Dynamic Temperature Change (tested at 0 deg. C to 60 deg. C with a 0.5 deg. C/minute temperature ramp)	Maintains 99.0% Accuracy
Sensor Compatibility	3M™ MicroTouch™ Capacitive Sensors
Communications Protocol	USB

Figure 4 Storage and Operating Temperature with Humidity Conditions

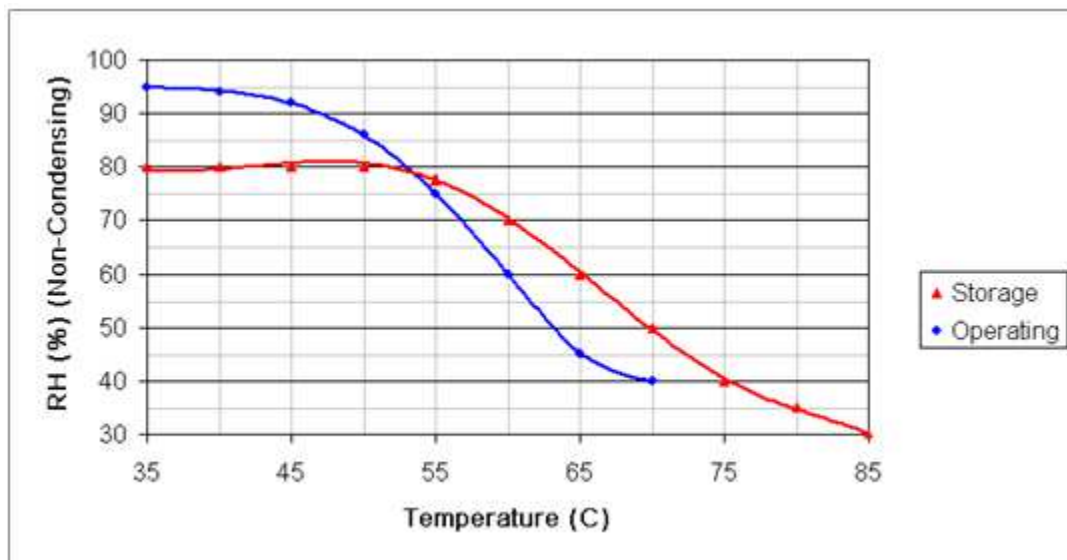

Данный компонент на территории Российской Федерации

Вы можете приобрести в компании MosChip.

Для оперативного оформления запроса Вам необходимо перейти по данной ссылке:

<http://moschip.ru/get-element>

Вы можете разместить у нас заказ для любого Вашего проекта, будь то серийное производство или разработка единичного прибора.

В нашем ассортименте представлены ведущие мировые производители активных и пассивных электронных компонентов.

Нашей специализацией является поставка электронной компонентной базы двойного назначения, продукции таких производителей как XILINX, Intel (ex.ALTERA), Vicor, Microchip, Texas Instruments, Analog Devices, Mini-Circuits, Amphenol, Glenair.

Сотрудничество с глобальными дистрибьюторами электронных компонентов, предоставляет возможность заказывать и получать с международных складов практически любой перечень компонентов в оптимальные для Вас сроки.

На всех этапах разработки и производства наши партнеры могут получить квалифицированную поддержку опытных инженеров.

Система менеджмента качества компании отвечает требованиям в соответствии с ГОСТ Р ИСО 9001, ГОСТ РВ 0015-002 и ЭС РД 009

Офис по работе с юридическими лицами:

105318, г.Москва, ул.Щербаковская д.3, офис 1107, 1118, ДЦ «Щербаковский»

Телефон: +7 495 668-12-70 (многоканальный)

Факс: +7 495 668-12-70 (доб.304)

E-mail: info@moschip.ru

Skype отдела продаж:

moschip.ru

moschip.ru_4

moschip.ru_6

moschip.ru_9