



Main

Range of product	Modicon TM5
Product or component type	Discrete input module
Discrete input number	2
Discrete input voltage	24 V

Complementary

Range compatibility	Modicon LMC058 Modicon M258 PacDrive LMC motion controller
Product compatibility	Motion controller Logic controller PacDrive LMC Pro PacDrive LMC Eco PacDrive LMC Pro 2
Discrete input voltage type	DC
Input voltage limits	20.4...28.8 V
Discrete input logic	Sink
Discrete input current	3.75 mA
Input impedance	6.4 kOhm
Color	White
Voltage state 0 guaranteed	≤ 5 V
Voltage state 1 guaranteed	≥ 15 V
Input filtering	≤ 25 ms configurable by software ≤ 100 ms hardware
Protection type	Overload protection Short-circuit protection
Isolation	No insulation between channels 500 Vrms AC insulation between channel and bus
Voltage drop	≤ 2 V at 500 mA for sensor supply
Supply current for sensors	500 mA
Current consumption	12 mA 24 V DC all inputs On 24 mA 5 V DC bus
Power dissipation in W	≤ 0.41 W
Local signalling	1 LED green power supply 1 LED red power supply 2 LEDs green input status
Electrical connection	3 wires
Marking	CE
Product weight	0.06 lb(US) (0.025 kg)

Environment

standards	CSA C22.2 No 142 IEC 61131-2 UL 508 CSA C22.2 No 213
product certifications	CSA

The information provided in this documentation contains general descriptions and/or technical characteristics of the performance of the products contained herein. This documentation is not intended as a substitute for and is not to be used for determining suitability or reliability of these products for specific user applications. It is the duty of any such user or integrator to perform the appropriate and complete risk analysis, evaluation and testing of the products with respect to the relevant specific application or use thereof. Neither Schneider Electric Industries SAS nor any of its affiliates or subsidiaries shall be responsible or liable for misuse of the information contained herein.

	C-Tick CULus GOST-R
ambient air temperature for operation	14...122 °F (-10...50 °C) vertical installation 14...140 °F (-10...60 °C) with derating factor horizontal installation 14...131 °F (-10...55 °C) without derating factor horizontal installation
ambient air temperature for storage	-40...158 °F (-40...70 °C)
relative humidity	5...95 % without condensation
IP degree of protection	IP20 conforming to IEC 61131-2
pollution degree	2 conforming to IEC 60664
operating altitude	0...6561.68 ft (0...2000 m)
storage altitude	0...9842.52 ft (0...3000 m)
vibration resistance	1 gn (f = 8.4...150 Hz) DIN rail 3.5 mm (f = 5...8.4 Hz) DIN rail
shock resistance	15 gn 11 ms
electromagnetic compatibility	Conducted and radiated emissions conforming to CISPR 11 Conducted RF disturbances conforming to EN/IEC 61000-4-6 Electrostatic discharge immunity test (4 kV - on contact) conforming to EN/IEC 61000-4-2 Electrostatic discharge immunity test (8 kV - in air) conforming to EN/IEC 61000-4-2 Susceptibility to electromagnetic fields (1 V/m - 2...2.7 GHz) conforming to EN/IEC 61000-4-3 Susceptibility to electromagnetic fields (10 V/m - 80...2000 MHz) conforming to EN/IEC 61000-4-3 Electrical fast transient/burst immunity test (1 kV - I/O) conforming to EN/IEC 61000-4-4 Electrical fast transient/burst immunity test (1 kV - shielded cable) conforming to EN/IEC 61000-4-4 Electrical fast transient/burst immunity test (2 kV - power lines) conforming to EN/IEC 61000-4-4 1.2/50 µs shock waves immunity test (0.5 kV - differential mode) conforming to EN/IEC 61000-4-5 1.2/50 µs shock waves immunity test (1 kV - common mode) conforming to EN/IEC 61000-4-5

Offer Sustainability

Green Premium product	Green Premium product
Compliant - since 1039 - Schneider Electric declaration of conformity	Compliant - since 1039 - Schneider Electric declaration of conformity
Reference not containing SVHC above the threshold	Reference not containing SVHC above the threshold
Available	Available
Available	Available
WARNING: This product can expose you to chemicals including:	WARNING: This product can expose you to chemicals including:
Lead and lead compounds, which is known to the State of California to cause cancer and birth defects or other reproductive harm.	Lead and lead compounds, which is known to the State of California to cause cancer and birth defects or other reproductive harm.
For more information go to www.p65warnings.ca.gov	For more information go to www.p65warnings.ca.gov

Contractual warranty

Warranty period	18 months
-----------------	-----------

TM5 Slice

Dimensions

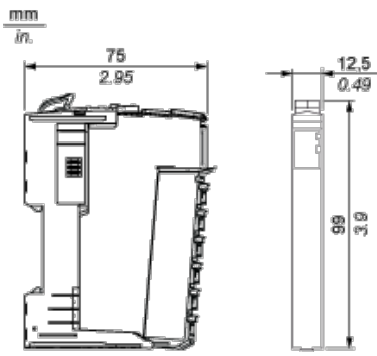

TM5 System

Spacing Requirements

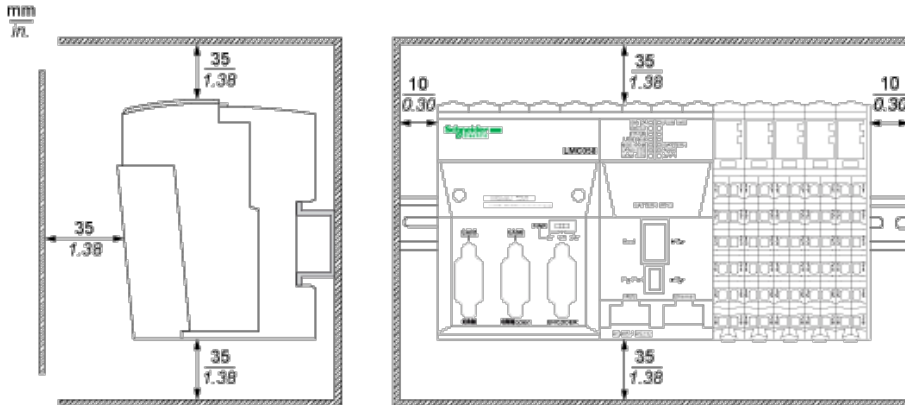



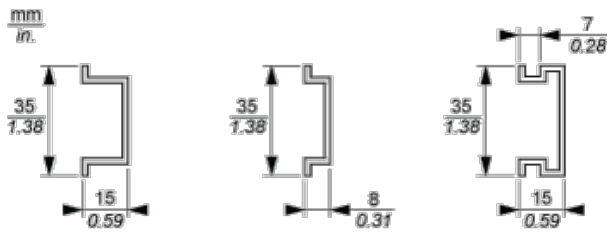

Mounting on a DIN Rail



TM5 System Wiring Recommendations

Wire Sizes to Use with the Removable Spring Terminal Blocks

mm in.				
mm ²	0,08...2,5	0,25...2,5	0,25...1,5	2 x 0,25...2 x 0,75
AWG	28...14	24...14	24...16	2 x 24...2 x 18

Electronic Module 2DI 24 Vdc Sink 3 Wires

Wiring Diagram

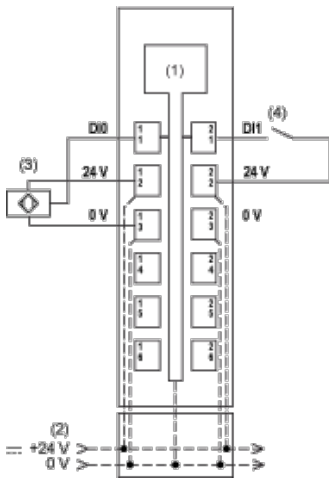

- (1) Internal electronics
- (2) 24 Vdc I/O power segment integrated into the bus bases
- (3) 3-wire sensor
- (4) 2-wire sensor

Данный компонент на территории Российской Федерации

Вы можете приобрести в компании MosChip.

Для оперативного оформления запроса Вам необходимо перейти по данной ссылке:

<http://moschip.ru/get-element>

Вы можете разместить у нас заказ для любого Вашего проекта, будь то серийное производство или разработка единичного прибора.

В нашем ассортименте представлены ведущие мировые производители активных и пассивных электронных компонентов.

Нашей специализацией является поставка электронной компонентной базы двойного назначения, продукции таких производителей как XILINX, Intel (ex.ALTERA), Vicor, Microchip, Texas Instruments, Analog Devices, Mini-Circuits, Amphenol, Glenair.

Сотрудничество с глобальными дистрибьюторами электронных компонентов, предоставляет возможность заказывать и получать с международных складов практически любой перечень компонентов в оптимальные для Вас сроки.

На всех этапах разработки и производства наши партнеры могут получить квалифицированную поддержку опытных инженеров.

Система менеджмента качества компании отвечает требованиям в соответствии с ГОСТ Р ИСО 9001, ГОСТ РВ 0015-002 и ЭС РД 009

Офис по работе с юридическими лицами:

105318, г.Москва, ул.Щербаковская д.3, офис 1107, 1118, ДЦ «Щербаковский»

Телефон: +7 495 668-12-70 (многоканальный)

Факс: +7 495 668-12-70 (доб.304)

E-mail: info@moschip.ru

Skype отдела продаж:

moschip.ru

moschip.ru_4

moschip.ru_6

moschip.ru_9