

Features

- $BV_{CEO} > -32V$
- Max Continuous Current $I_C = -1A$
- Epitaxial Planar Die Construction
- Complementary NPN Type Available (2DD1664)
- Ideally Suited for Automated Assembly Processes
- Ideal for Medium Power Switching or Amplification Applications
- **Lead Free, RoHS Compliant (Note 1)**
- **Halogen and Antimony Free, "Green" Devices (Note 2)**

Mechanical Data

- Case: SOT-89
- Case material: molded Plastic. "Green" molding Compound.
- UL Flammability Rating 94V-0
- Moisture Sensitivity: Level 1 per J-STD-020
- Terminals: Matte Tin Finish
- Weight: 0.055 grams (Approximate)

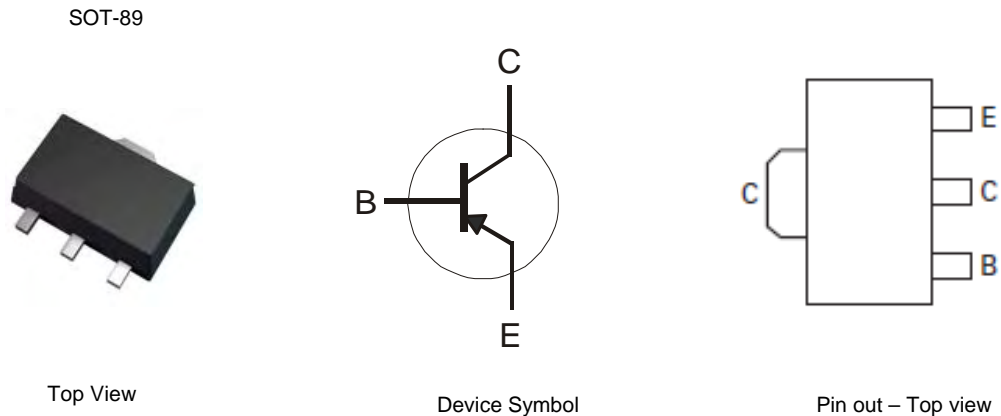

Ordering Information

Product	Grade	Marking	Reel size (inches)	Tape width (mm)	Quantity per reel
2DB1132P-13	Commercial	P13P	13	12	2,500
2DB1132Q-13	Commercial	P13Q	13	12	2,500
2DB1132R-13	Commercial	P13R	13	12	2,500

Notes: 1. No purposefully added lead.
2. "Green" devices, Halogen and Antimony Free, Diodes Inc's "Green" Policy can be found on our website at <http://www.diodes.com>

Marking Information

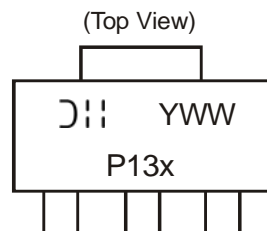

P13x = Product Type Marking Code:
Where P13P = 2DB1132P
P13Q = 2DB1132Q
P13R = 2DB1132R
YWW = Date Code Marking
Y = Last digit of year ex: 7 = 2007
WW = Week code 01 - 52

Maximum Ratings @T_A = 25°C unless otherwise specified

Characteristic	Symbol	Value	Unit
Collector-Base Voltage	V _{CBO}	-40	V
Collector-Emitter Voltage	V _{CEO}	-32	V
Emitter-Base Voltage	V _{EBO}	-5	V
Continuous Collector Current	I _C	-1	A
Peak Pulse Current (Note 4)	I _{CM}	-2	A

Thermal Characteristics @T_A = 25°C unless otherwise specified

Characteristic	Symbol	Value	Unit
Power Dissipation (Note 3)	P _D	1	W
Thermal Resistance, Junction to Ambient (Note 3)	R _{θJA}	125	°C/W
Thermal Resistance, Junction to Leads (Note 5)	R _{θJL}	22	°C/W
Operating and Storage Temperature Range	T _J , T _{STG}	-55 to +150	°C

- Notes:
- 3. For a device surface mounted on FR-4 PCB with minimum suggested pad layout; high coverage of single sided 1 oz copper, in still air conditions
 - 4. Measured under pulsed conditions. Pulse width = 300µs. Duty cycle ≤ 2%.
 - 5. Thermal resistance from junction to solder-point (at the end of the collector lead).

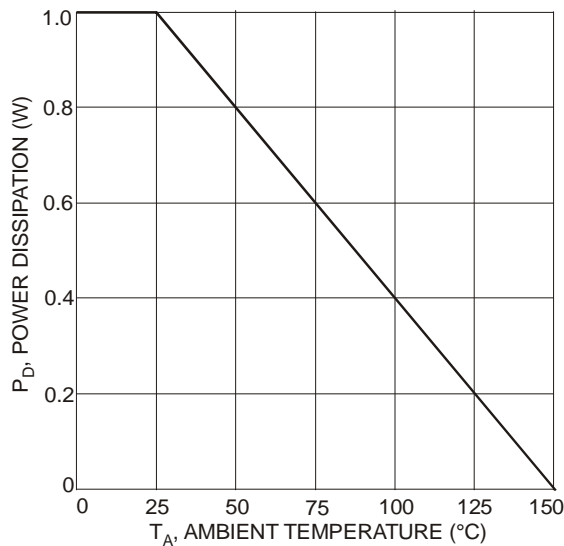

Fig. 1 Power Dissipation vs. Ambient Temperature (Note 3)

Electrical Characteristics @ $T_A = 25^\circ\text{C}$ unless otherwise specified

Characteristic	Symbol	Min	Typ	Max	Unit	Test Condition
Collector-Base Breakdown Voltage	BV_{CBO}	-40	-	-	V	$I_C = -50\mu\text{A}$
Collector-Emitter Breakdown Voltage (Note 6)	BV_{CEO}	-32	-	-	V	$I_C = -1\text{mA}$
Emitter-Base Breakdown Voltage	BV_{EBO}	-5	-	-	V	$I_E = -50\mu\text{A}$
Collector Cut-off Current	I_{CBO}	-	-	-0.5	μA	$V_{CB} = -20\text{V}$
Emitter Cut-off Current	I_{EBO}	-	-	-0.5	μA	$V_{EB} = -4\text{V}$
Static Forward Current Transfer Ratio (Note 6)	h_{FE}	82	-	180	-	$I_C = -100\text{mA}, V_{CE} = -3\text{V}$
		120		270		
		180		390		
Collector-Emitter saturation Voltage (Note 6)	$V_{CE(sat)}$	-	-125	-500	mV	$I_C = -500\text{mA}, I_B = -50\text{mA}$
Transition frequency	f_T	-	190	-	MHz	$I_E = 50\text{mA}, V_{CE} = -5\text{V}, f = 30\text{MHz}$
Output Capacitance	C_{ob}	-	12	30	pF	$I_E = 0\text{A}, V_{CB} = -10\text{V}, f = 1\text{MHz}$

Notes: 6. Measured under pulsed conditions. Pulse width = 300 μs . Duty cycle $\leq 2\%$

Electrical Characteristics

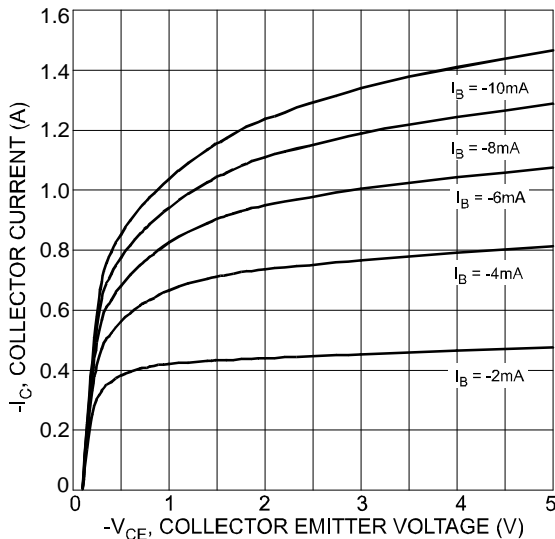

Fig. 2 Typical Collector Current vs. Collector-Emitter Voltage

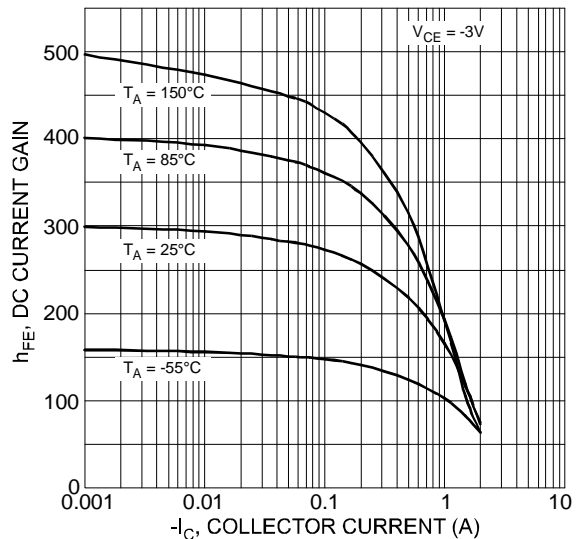

Fig. 3 Typical DC Current Gain vs. Collector Current (2DB1132R)

Electrical Characteristic - (cont.)

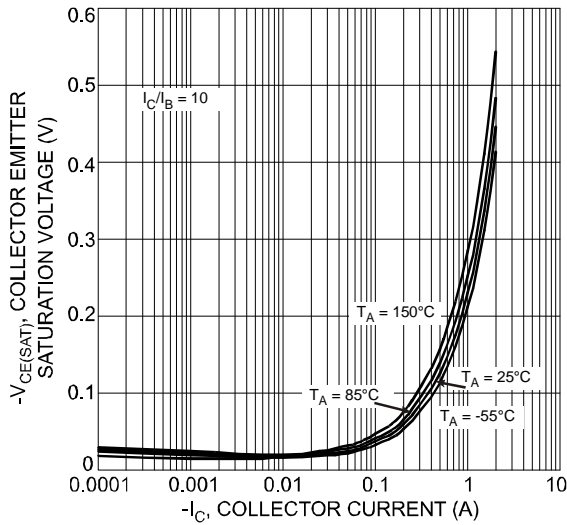

Fig. 4 Typical Collector-Emitter Saturation Voltage vs. Collector Current

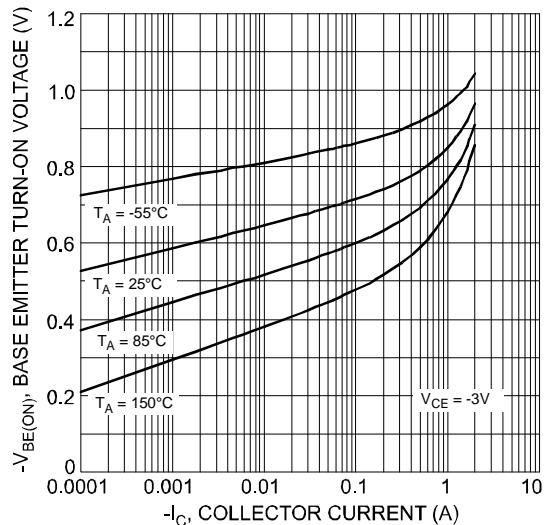

Fig. 5 Typical Base-Emitter Turn-On Voltage vs. Collector Current

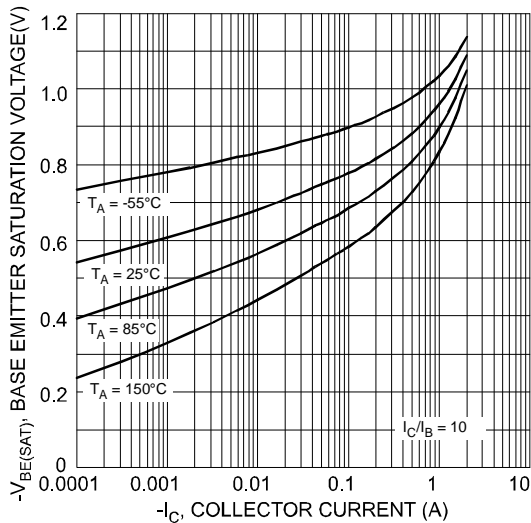

Fig. 6 Typical Base-Emitter Saturation Voltage vs. Collector Current

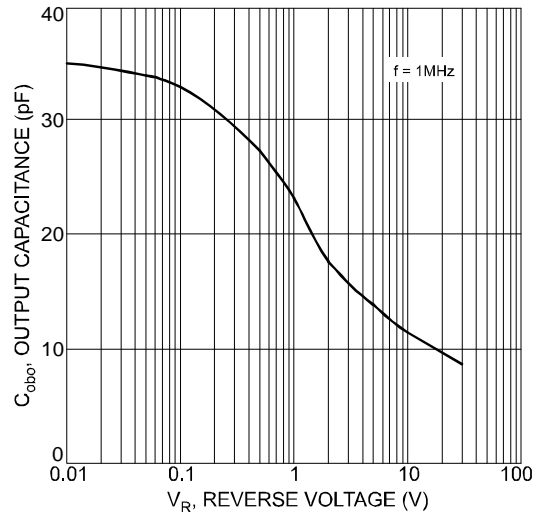

Fig. 7 Typical Output Capacitance Characteristics

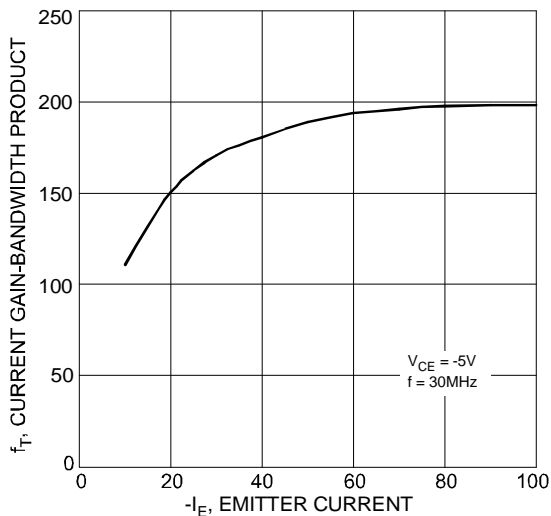
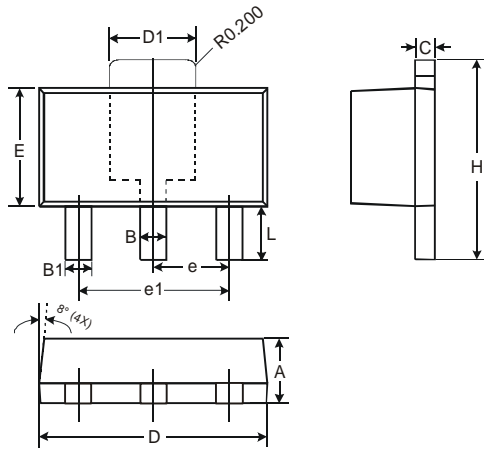

Fig. 8 Typical Gain-Bandwidth Product vs. Emitter Current

Package Outline Dimensions



SOT89		
Dim	Min	Max
A	1.40	1.60
B	0.44	0.62
B1	0.35	0.54
C	0.35	0.43
D	4.40	4.60
D1	1.52	1.83
E	2.29	2.60
e	1.50 Typ	
e1	3.00 Typ	
H	3.94	4.25
L	0.89	1.20
All Dimensions in mm		

Suggested Pad Layout

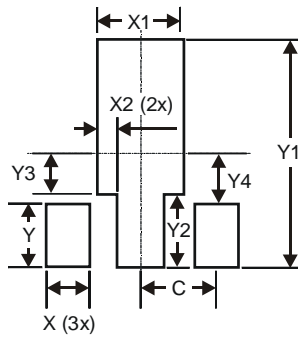

Dimensions	Value (in mm)
X	0.900
X1	1.733
X2	0.416
Y	1.300
Y1	4.600
Y2	1.475
Y3	0.950
Y4	1.125
C	1.500

IMPORTANT NOTICE

DIODES INCORPORATED MAKES NO WARRANTY OF ANY KIND, EXPRESS OR IMPLIED, WITH REGARDS TO THIS DOCUMENT, INCLUDING, BUT NOT LIMITED TO, THE IMPLIED WARRANTIES OF MERCHANTABILITY AND FITNESS FOR A PARTICULAR PURPOSE (AND THEIR EQUIVALENTS UNDER THE LAWS OF ANY JURISDICTION).

Diodes Incorporated and its subsidiaries reserve the right to make modifications, enhancements, improvements, corrections or other changes without further notice to this document and any product described herein. Diodes Incorporated does not assume any liability arising out of the application or use of this document or any product described herein; neither does Diodes Incorporated convey any license under its patent or trademark rights, nor the rights of others. Any Customer or user of this document or products described herein in such applications shall assume all risks of such use and will agree to hold Diodes Incorporated and all the companies whose products are represented on Diodes Incorporated website, harmless against all damages.

Diodes Incorporated does not warrant or accept any liability whatsoever in respect of any products purchased through unauthorized sales channel. Should Customers purchase or use Diodes Incorporated products for any unintended or unauthorized application, Customers shall indemnify and hold Diodes Incorporated and its representatives harmless against all claims, damages, expenses, and attorney fees arising out of, directly or indirectly, any claim of personal injury or death associated with such unintended or unauthorized application.

Products described herein may be covered by one or more United States, international or foreign patents pending. Product names and markings noted herein may also be covered by one or more United States, international or foreign trademarks.

LIFE SUPPORT

Diodes Incorporated products are specifically not authorized for use as critical components in life support devices or systems without the express written approval of the Chief Executive Officer of Diodes Incorporated. As used herein:

A. Life support devices or systems are devices or systems which:

1. are intended to implant into the body, or
2. support or sustain life and whose failure to perform when properly used in accordance with instructions for use provided in the labeling can be reasonably expected to result in significant injury to the user.

B. A critical component is any component in a life support device or system whose failure to perform can be reasonably expected to cause the failure of the life support device or to affect its safety or effectiveness.

Customers represent that they have all necessary expertise in the safety and regulatory ramifications of their life support devices or systems, and acknowledge and agree that they are solely responsible for all legal, regulatory and safety-related requirements concerning their products and any use of Diodes Incorporated products in such safety-critical, life support devices or systems, notwithstanding any devices- or systems-related information or support that may be provided by Diodes Incorporated. Further, Customers must fully indemnify Diodes Incorporated and its representatives against any damages arising out of the use of Diodes Incorporated products in such safety-critical, life support devices or systems.

Copyright © 2011, Diodes Incorporated

www.diodes.com

Данный компонент на территории Российской Федерации

Вы можете приобрести в компании MosChip.

Для оперативного оформления запроса Вам необходимо перейти по данной ссылке:

<http://moschip.ru/get-element>

Вы можете разместить у нас заказ для любого Вашего проекта, будь то серийное производство или разработка единичного прибора.

В нашем ассортименте представлены ведущие мировые производители активных и пассивных электронных компонентов.

Нашей специализацией является поставка электронной компонентной базы двойного назначения, продукции таких производителей как XILINX, Intel (ex.ALTERA), Vicor, Microchip, Texas Instruments, Analog Devices, Mini-Circuits, Amphenol, Glenair.

Сотрудничество с глобальными дистрибьюторами электронных компонентов, предоставляет возможность заказывать и получать с международных складов практически любой перечень компонентов в оптимальные для Вас сроки.

На всех этапах разработки и производства наши партнеры могут получить квалифицированную поддержку опытных инженеров.

Система менеджмента качества компании отвечает требованиям в соответствии с ГОСТ Р ИСО 9001, ГОСТ РВ 0015-002 и ЭС РД 009

Офис по работе с юридическими лицами:

105318, г.Москва, ул.Щербаковская д.3, офис 1107, 1118, ДЦ «Щербаковский»

Телефон: +7 495 668-12-70 (многоканальный)

Факс: +7 495 668-12-70 (доб.304)

E-mail: info@moschip.ru

Skype отдела продаж:

moschip.ru

moschip.ru_4

moschip.ru_6

moschip.ru_9