

## Fast Thyristor/Diode and Thyristor/Thyristor (MAGN-A-PAK Power Modules), 200 A

**MAGN-A-PAK**
**FEATURES**

- Fast turn-off thyristor
- Fast recovery diode
- High surge capability
- Electrically isolated baseplate
- 3500 V<sub>RMS</sub> isolating voltage
- Industrial standard package
- UL approved file E78996 
- Compliant to RoHS directive 2002/95/EC
- Designed and qualified for industrial level

**RoHS  
COMPLIANT**
**PRODUCT SUMMARY**

$I_{T(AV)}$	200 A
Type	Modules - Thyristor, Fast

**DESCRIPTION**

This series of MAGN-A-PAK modules are intended for applications such as self-commutated inverters, DC choppers, electronic welders, induction heating and others where fast switching characteristics are required.

**MAJOR RATINGS AND CHARACTERISTICS**

SYMBOL	CHARACTERISTICS	VALUES	UNITS
$I_{T(AV)}$		200	A
	$T_C$	85	°C
$I_{T(RMS)}$		444	A
$I_{TSM}$	50 Hz	7600	
	60 Hz	8000	
$I^2t$	50 Hz	290	kA <sup>2</sup> s
	60 Hz	265	
$I^2\sqrt{t}$		2900	kA <sup>2</sup> √s
$t_q$		20/25	μs
$t_{rr}$		2	
$V_{DRM}/V_{RRM}$		800/1200	V
$T_J$	Range	- 40 to 125	°C

**ELECTRICAL SPECIFICATIONS**
**VOLTAGE RATINGS**

TYPE NUMBER	VOLTAGE CODE	$V_{RRM}/V_{DRM}$ , MAXIMUM REPETITIVE PEAK REVERSE AND OFF-STATE BLOCKING VOLTAGE V	$V_{RSM}$ , MAXIMUM NON-REPETITIVE PEAK REVERSE VOLTAGE V	$I_{RRM}/I_{DRM}$ AT $T_J = 125^\circ\text{C}$ mA
VSK.F200-	08	800	800	50
	12	1200	1200	

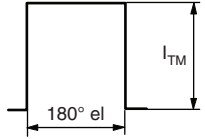
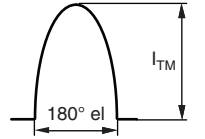
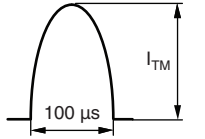
CURRENT CARRYING CAPABILITY							
FREQUENCY							UNITS
50 Hz	380	560	630	850	2460	3180	A
400 Hz	460	690	710	1060	1570	2080	
2500 Hz	310	450	530	760	630	860	
5000 Hz	250	360	410	560	410	560	
10 000 Hz	180	280	300	410	-	-	
Recovery voltage $V_r$	50	50	50	50	50	50	V
Voltage before turn-on $V_d$	80 % $V_{DRM}$		80 % $V_{DRM}$		80 % $V_{DRM}$		
Rise of on-state current $di/dt$	50	50	-	-	-	-	A/μs
Case temperature	85	60	85	60	85	60	°C
Equivalent values for RC circuit	10/0.47		10/0.47		10/0.47		Ω/μF

ON-STATE CONDUCTION					
PARAMETER	SYMBOL	TEST CONDITIONS		VALUES	UNITS
Maximum average on-state current at case temperature	$I_{T(AV)}$	180° conduction, half sine wave		200	A
				85	°C
Maximum RMS on-state current	$I_{T(RMS)}$	As AC switch		444	A
Maximum peak, one-cycle non-repetitive on-state, surge current	$I_{TSM}$	t = 10 ms	No voltage reapplied	7600	
		t = 8.3 ms		8000	
		t = 10 ms	100 % $V_{RRM}$ reapplied	6400	
		t = 8.3 ms		6700	
Maximum $I^2t$ for fusing	$I^2t$	t = 10 ms	No voltage reapplied	290	kA <sup>2</sup> s
		t = 8.3 ms		265	
		t = 10 ms	100 % $V_{RRM}$ reapplied	205	
		t = 8.3 ms		187	
Maximum $I^2\sqrt{t}$ for fusing	$I^2\sqrt{t}$	t = 0.1 ms to 10 ms, no voltage reapplied		2900	kA <sup>2</sup> √s
Low level value or threshold voltage	$V_{T(TO)1}$	(16.7 % $\times \pi \times I_{T(AV)} < I < \pi \times I_{T(AV)}$ , $T_J = T_J$ maximum)		1.18	V
High level value of threshold voltage	$V_{T(TO)2}$	(16.7 % $\times \pi \times I_{T(AV)} < I < \pi \times I_{T(AV)}$ , $T_J = T_J$ maximum)		1.25	
Low level value on-state slope resistance	$r_{t1}$	(16.7 % $\times \pi \times I_{T(AV)} < I < \pi \times I_{T(AV)}$ , $T_J = T_J$ maximum)		0.74	mΩ
High level value on-state slope resistance	$r_{t2}$	(16.7 % $\times \pi \times I_{T(AV)} < I < \pi \times I_{T(AV)}$ , $T_J = T_J$ maximum)		0.70	
Maximum on-state voltage drop	$V_{TM}$	$I_{pk} = 600$ A, $T_J = T_J$ maximum, $t_p = 10$ ms sine pulse		1.73	V
Maximum holding current	$I_H$	$T_J = 25$ °C, $I_T > 30$ A		600	mA
Maximum latching current	$I_L$	$T_J = 25$ °C, $V_A = 12$ V, $R_a = 6$ Ω, $I_g = 1$ A		1000	



SWITCHING					
PARAMETER	SYMBOL	TEST CONDITIONS	VALUES		UNITS
			K	J	
Maximum non-repetitive rate of rise	$di/dt$	Gate drive 20 V, 20 $\Omega$ , $t_r \leq 1$ ms, $V_D = 80\%$ $V_{DRM}$ , $T_J = 25$ °C	800		A/ $\mu$ s
Maximum recovery time	$t_{rr}$	$I_{TM} = 350$ A, $di/dt = -25$ A/ $\mu$ s, $V_R = 50$ V, $T_J = 25$ °C	2		$\mu$ s
Maximum turn-off time	$t_q$	$I_{TM} = 750$ A; $T_J = T_J$ maximum; $di/dt = -25$ A/ $\mu$ s; $V_R = 50$ V; $dV/dt = 400$ V/ $\mu$ s linear to 80 % $V_{DRM}$	20	25	

BLOCKING				
PARAMETER	SYMBOL	TEST CONDITIONS	VALUES	UNITS
Maximum critical rate of rise of off-state voltage	$dV/dt$	$T_J = 125$ °C, exponential to 67 % $V_{DRM}$	1000	V/ $\mu$ s
RMS insulation voltage	$V_{INS}$	50 Hz, circuit to base, $T_J = 25$ °C, $t = 1$ s	3000	V
Maximum peak reverse and off-state leakage current	$I_{RRM}$ , $I_{DRM}$	$T_J = 125$ °C, rated $V_{DRM}/V_{RRM}$ applied	50	mA

TRIGGERING				
PARAMETER	SYMBOL	TEST CONDITIONS	VALUES	UNITS
Maximum peak gate power	$P_{GM}$	$f = 50$ Hz, $d\% = 50$	60	W
Maximum peak average gate power	$P_{G(AV)}$	$T_J = 125$ °C, $f = 50$ Hz, $d\% = 50$	10	
Maximum peak positive gate current	$I_{GM}$	$T_J = 125$ °C, $t_p \leq 5$ ms	10	A
Maximum peak negative gate voltage	$-V_{GT}$		5	V
Maximum DC gate current required to trigger	$I_{GT}$	$T_J = 25$ °C, $V_{ak} 12$ V, $R_a = 6$	200	mA
DC gate voltage required to trigger	$V_{GT}$		3	V
DC gate current not to trigger	$I_{GD}$	$T_J = 125$ °C, rated $V_{DRM}$ applied	20	mA
DC gate voltage not to trigger	$V_{GD}$		0.25	V

THERMAL AND MECHANICAL SPECIFICATIONS				
PARAMETER	SYMBOL	TEST CONDITIONS	VALUES	UNITS
Maximum junction operating temperature range	$T_J$		- 40 to 125	°C
Storage temperature range	$T_{Stg}$		- 40 to 150	
Maximum thermal resistance, junction to case per junction	$R_{thJC}$	DC operation	0.125	K/W
Maximum thermal resistance, case to heatsink per module	$R_{thC-hs}$	Mounting surface flat, smooth and greased	0.025	
Mounting torque $\pm 10\%$ — MAP to heatsink — busbar to MAP		A mounting compound is recommended. The torque should be rechecked after a period of 3 hours to allow for the spread of the compound. Use of cable lugs is not recommended, busbar should be used and restrained during tightening. Threads must be lubricated with a compound.	4 to 6 (35 to 53)	N · m (lb · in)
Approximate weight			500	g
			17.8	oz.
Case style			MAGN-A-PAK	

$\Delta R_{thJC}$ CONDUCTION			
CONDUCTIONS ANGLE	SINUSOIDAL CONDUCTION	RECTANGULAR CONDUCTION	UNITS
180°	0.009	0.006	K/W
120°	0.10	0.011	
90°	0.014	0.015	
60°	0.020	0.020	
30°	0.32	0.033	

**Note**

- Table shows the increment of thermal resistance  $R_{thJC}$  when devices operate at different conduction angles than DC



Fig. 1 - Current Ratings Characteristics



Fig. 3 - On-State Power Loss Characteristics



Fig. 2 - Current Ratings Characteristics

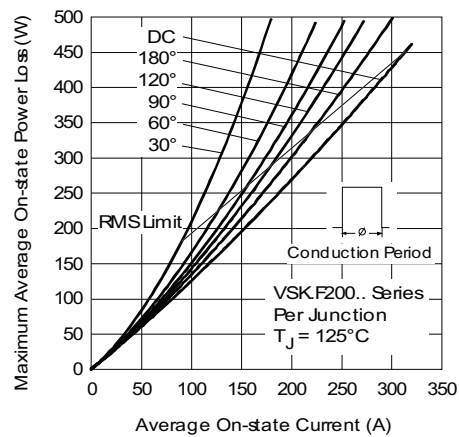

Fig. 4 - On-State Power Loss Characteristics



Fig. 5 - Maximum Non-Repetitive Surge Current



Fig. 8 - Thermal Impedance  $Z_{thJC}$  Characteristics



Fig. 6 - Maximum Non-Repetitive Surge Current



Fig. 9 - Reverse Recovery Charge Characteristics

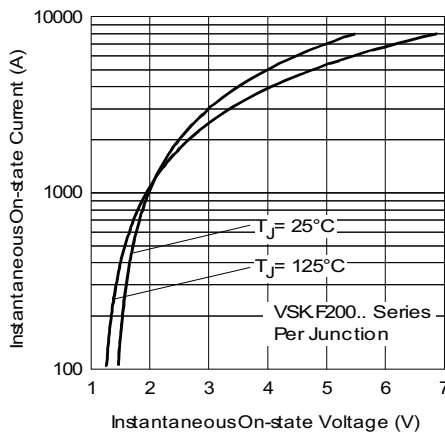

Fig. 7 - On-State Voltage Drop Characteristics



Fig. 10 - Reverse Recovery Current Characteristics

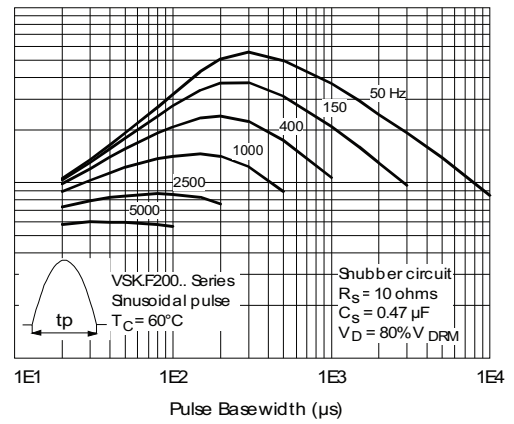
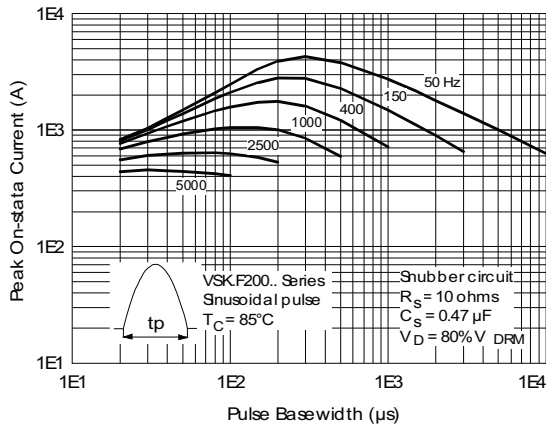

Fig. 11 - Frequency Characteristics

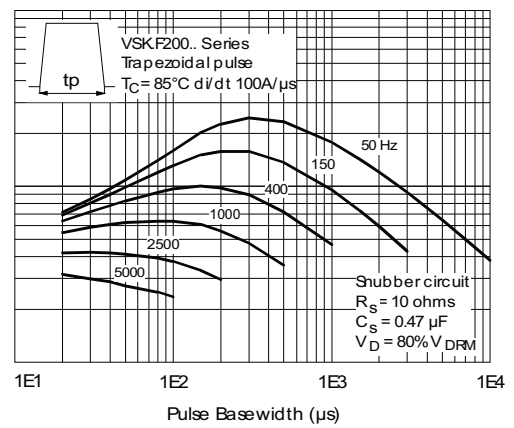
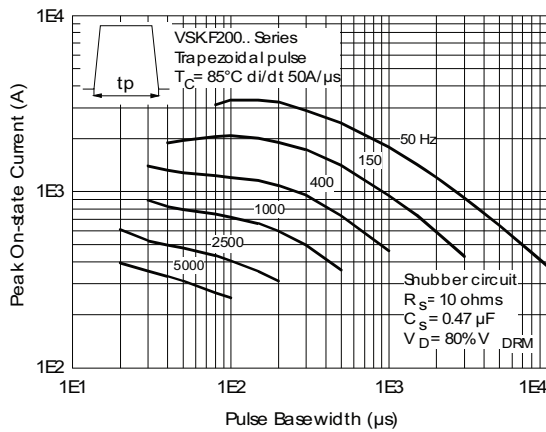

Fig. 12 - Frequency Characteristics

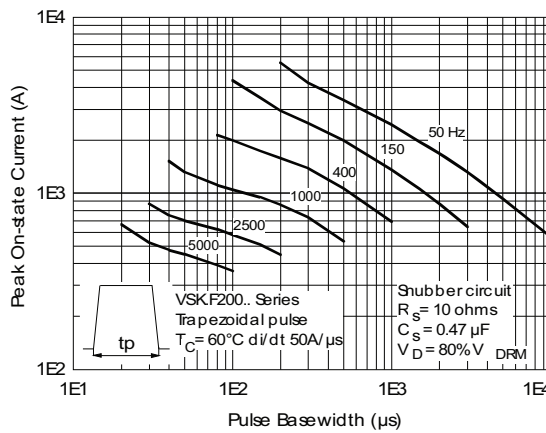

Fig. 13 - Frequency Characteristics

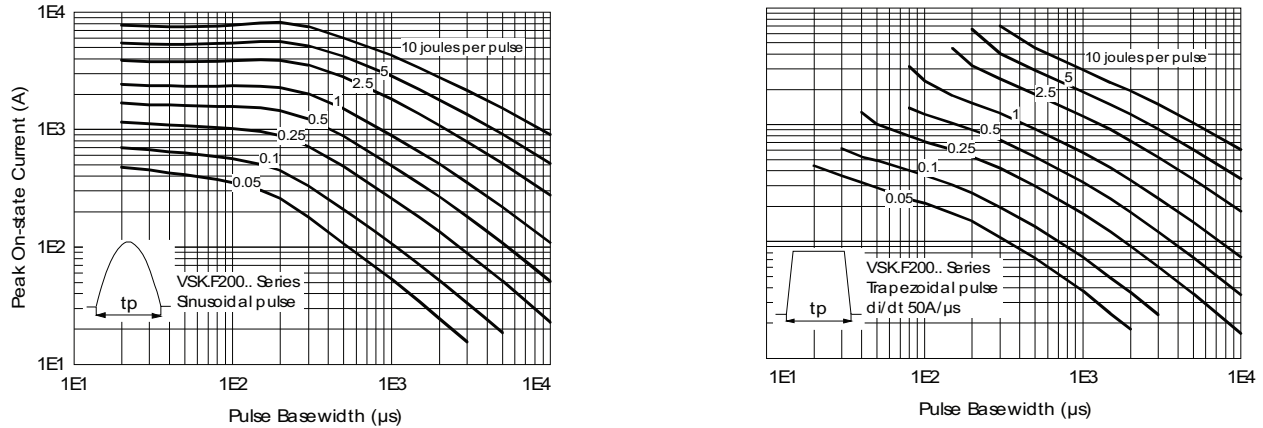

Fig. 14 - Maximum On-State Energy Power Loss Characteristics



Fig. 15 - Gate Characteristics

# VSK.F200..P Series



Vishay Semiconductors Fast Thyristor/Diode and Thyristor/Thyristor  
(MAGN-A-PAK Power Modules), 200 A

## ORDERING INFORMATION TABLE

Device code	<b>VSK</b>	<b>T</b>	<b>F</b>	<b>200</b>	<b>-</b>	<b>12</b>	<b>H</b>	<b>K</b>	<b>P</b>
	①	②	③	④		⑤	⑥	⑦	⑧
	<b>1</b>	-	Module type						
	<b>2</b>	-	Circuit configuration (see circuit configuration table)						
	<b>3</b>	-	Fast SCR						
	<b>4</b>	-	Current rating: $I_{T(AV)} \times 10$ rounded						
	<b>5</b>	-	Voltage code $\times 100 = V_{RRM}$ (see Voltage Ratings table)						
	<b>6</b>	-	dV/dt code: $H \leq 400 \text{ V}/\mu\text{s}$						
	<b>7</b>	-	$t_q$ code: $K \leq 20 \mu\text{s}$ $J \leq 25 \mu\text{s}$						
	<b>8</b>	-	Lead (Pb)-free						

### Note

- To order the optional hardware go to [www.vishay.com/doc?95172](http://www.vishay.com/doc?95172)

CIRCUIT CONFIGURATION		
CIRCUIT DESCRIPTION	CIRCUIT CONFIGURATION CODE	CIRCUIT DRAWING
Two SCRs common cathodes	U	<p><b>VSKUF..</b></p>
SCR/diode common cathodes	K	<p><b>VSKKF..</b></p>
Two SCRs common anodes	V	<p><b>VSKVF..</b></p>





<b>CIRCUIT CONFIGURATION</b>		
<b>CIRCUIT DESCRIPTION</b>	<b>CIRCUIT CONFIGURATION CODE</b>	<b>CIRCUIT DRAWING</b>
SCR/diode common anodes	N	<p><b>VSKNF..</b></p>
SCR/diode doubler circuit, negative control	L	<p><b>VSKLF..</b></p>
Two SCRs doubler circuit	T	<p><b>VSKTF..</b></p>
SCR/diode doubler circuit, positive control	H	<p><b>VSKHF..</b></p>

<b>LINKS TO RELATED DOCUMENTS</b>	
Dimensions	<a href="http://www.vishay.com/doc?95086">www.vishay.com/doc?95086</a>

## MAGN-A-PAK

**DIMENSIONS** in millimeters (inches)



### Notes

- Dimensions are nominal
- Full engineering drawings are available on request
- UL identification number for gate and cathode wire: UL 1385
- UL identification number for package: UL 94 V-0



## Disclaimer

ALL PRODUCT, PRODUCT SPECIFICATIONS AND DATA ARE SUBJECT TO CHANGE WITHOUT NOTICE TO IMPROVE RELIABILITY, FUNCTION OR DESIGN OR OTHERWISE.

Vishay Intertechnology, Inc., its affiliates, agents, and employees, and all persons acting on its or their behalf (collectively, "Vishay"), disclaim any and all liability for any errors, inaccuracies or incompleteness contained in any datasheet or in any other disclosure relating to any product.

Vishay makes no warranty, representation or guarantee regarding the suitability of the products for any particular purpose or the continuing production of any product. To the maximum extent permitted by applicable law, Vishay disclaims (i) any and all liability arising out of the application or use of any product, (ii) any and all liability, including without limitation special, consequential or incidental damages, and (iii) any and all implied warranties, including warranties of fitness for particular purpose, non-infringement and merchantability.

Statements regarding the suitability of products for certain types of applications are based on Vishay's knowledge of typical requirements that are often placed on Vishay products in generic applications. Such statements are not binding statements about the suitability of products for a particular application. It is the customer's responsibility to validate that a particular product with the properties described in the product specification is suitable for use in a particular application. Parameters provided in datasheets and/or specifications may vary in different applications and performance may vary over time. All operating parameters, including typical parameters, must be validated for each customer application by the customer's technical experts. Product specifications do not expand or otherwise modify Vishay's terms and conditions of purchase, including but not limited to the warranty expressed therein.

Except as expressly indicated in writing, Vishay products are not designed for use in medical, life-saving, or life-sustaining applications or for any other application in which the failure of the Vishay product could result in personal injury or death. Customers using or selling Vishay products not expressly indicated for use in such applications do so at their own risk and agree to fully indemnify and hold Vishay and its distributors harmless from and against any and all claims, liabilities, expenses and damages arising or resulting in connection with such use or sale, including attorneys fees, even if such claim alleges that Vishay or its distributor was negligent regarding the design or manufacture of the part. Please contact authorized Vishay personnel to obtain written terms and conditions regarding products designed for such applications.

No license, express or implied, by estoppel or otherwise, to any intellectual property rights is granted by this document or by any conduct of Vishay. Product names and markings noted herein may be trademarks of their respective owners.

## Данный компонент на территории Российской Федерации

### Вы можете приобрести в компании MosChip.

Для оперативного оформления запроса Вам необходимо перейти по данной ссылке:

<http://moschip.ru/get-element>

Вы можете разместить у нас заказ для любого Вашего проекта, будь то серийное производство или разработка единичного прибора.

В нашем ассортименте представлены ведущие мировые производители активных и пассивных электронных компонентов.

Нашей специализацией является поставка электронной компонентной базы двойного назначения, продукции таких производителей как XILINX, Intel (ex.ALTERA), Vicor, Microchip, Texas Instruments, Analog Devices, Mini-Circuits, Amphenol, Glenair.

Сотрудничество с глобальными дистрибьюторами электронных компонентов, предоставляет возможность заказывать и получать с международных складов практически любой перечень компонентов в оптимальные для Вас сроки.

На всех этапах разработки и производства наши партнеры могут получить квалифицированную поддержку опытных инженеров.

Система менеджмента качества компании отвечает требованиям в соответствии с ГОСТ Р ИСО 9001, ГОСТ РВ 0015-002 и ЭС РД 009

### Офис по работе с юридическими лицами:

105318, г.Москва, ул.Щербаковская д.3, офис 1107, 1118, ДЦ «Щербаковский»

Телефон: +7 495 668-12-70 (многоканальный)

Факс: +7 495 668-12-70 (доб.304)

E-mail: [info@moschip.ru](mailto:info@moschip.ru)

Skype отдела продаж:

moschip.ru

moschip.ru\_4

moschip.ru\_6

moschip.ru\_9