

# SURFACE MOUNT LED WHITE, 4014 PACKAGE, 0.2W

# BIVAR

## SM4014UWD~~X~~02

- ◆ Industry Standard 4014 Package
- ◆ RoHS Compliant
- ◆ Small Package and Footprint
- ◆ ~~X~~ - (C) Cool White, (N) Neutral White, (W) Warm White
- ◆ Wide Viewing Angle
- ◆ Ideal for Lighting and Backlighting Application

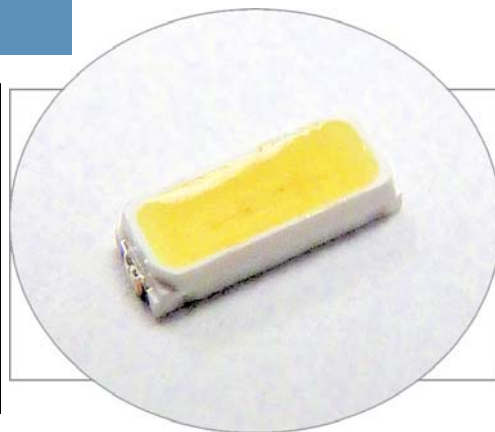

Bivar Surface Mount 4014 package LED may be used in nearly any lighting or backlighting application. These 0.2 Watt SMD LED's have a minimum CRI Value of 80 and are available in 3 color temperatures to meet any illumination needs: Cool, Neutral and Warm White. The SM4014 Series is conveniently packaged in standard tape and reels for pick and place assemblies.

Part Number	Material	Emitted Color	Lens Color	Luminous Flux (lm) TYP.	Viewing Angle
SM4014UWDC02	InGaN	Cool White	Diffused	22	120°
SM4014UWDN02	InGaN	Neutral White	Diffused	22	120°
SM4014UWDW02	InGaN	Warm White	Diffused	20	120°

## Outline Dimensions

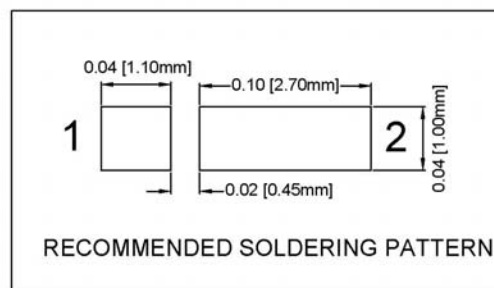
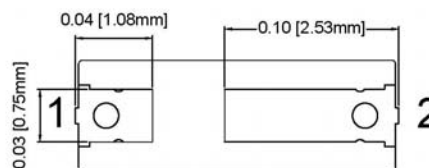
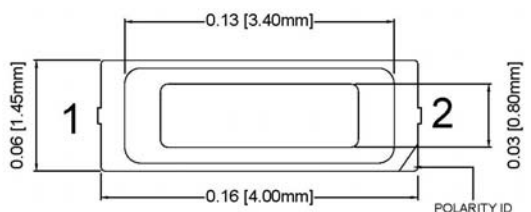

### Outline Drawings Notes:

1. All dimensions are in inches [millimeters].
2. Standard tolerance:  $\pm 0.010''$  unless otherwise noted.



Bivar reserves the right to make changes at any time without notice.

## Absolute Maximum Ratings

$T_A = 25^\circ\text{C}$  unless otherwise noted

Power Dissipation	0.21 W
Forward Current ( DC )	60 mA
Peak Forward Current <sup>1</sup>	120 mA
Reverse Voltage	5 V
Electrostatic Discharge (HBM)	2000 V
Operating Temperature Range	-40 ~ +85°C
Storage Temperature Range	-40 ~ +100°C
Junction Temperature	115°C
Lead Soldering Temperature <sup>2</sup>	260°C

Notes: 1.  $\leq 10\%$  Duty Cycle, Pulse Width  $\leq 0.1$  msec.  
2. Solder time less than 5 seconds at temperature extreme.

## Electrical / Optical Characteristics

$T_A = 25^\circ\text{C}$  &  $I_F = 60$  mA unless otherwise noted

Part Number	Forward Voltage (V)			Recommend Forward Current (mA)	Reverse Current ( $\mu\text{A}$ ) $V_R=5\text{V}$	CCT (Kelvin)			Luminous Flux (lm)			Viewing Angle $2\theta_{1/2}$ (deg)
	MIN	TYP	MAX	TYP	MAX	MIN	TYP	MAX	MIN	TYP	MAX	TYP
SM4014UWDC02	2.9	/	3.5	60	10	5800	6500	7300	18	22	26	120
SM4014UWDN02	2.9	/	3.5	60	10	3700	4000	4400	18	22	26	120
SM4014UWDW02	2.9	/	3.5	60	10	2750	3000	3150	18	20	26	120

Notes: 1. The above forward voltage measurement allowance tolerance is  $\pm 0.1\text{V}$ .  
2. The above luminous flux measurement allowance tolerance  $\pm 10\%$ .

# SURFACE MOUNT LED WHITE, 4014 PACKAGE, 0.2W



## Typical Electrical / Optical Characteristics

$T_A = 25^\circ\text{C}$  unless otherwise noted

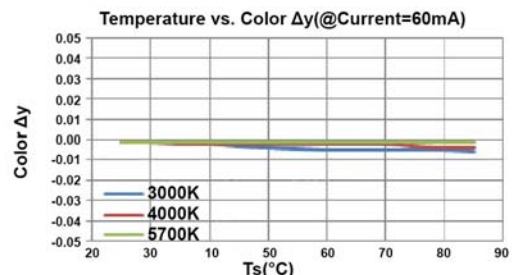
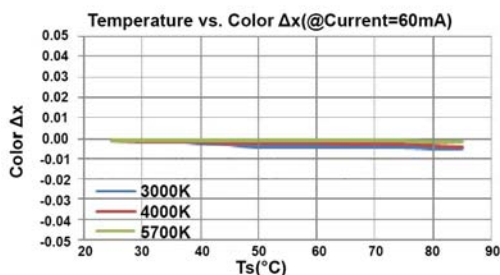
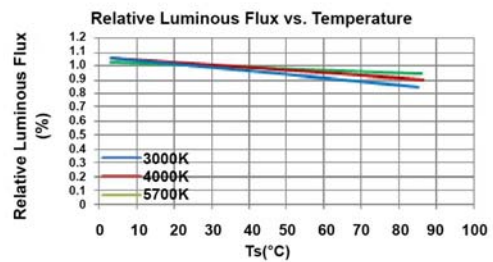
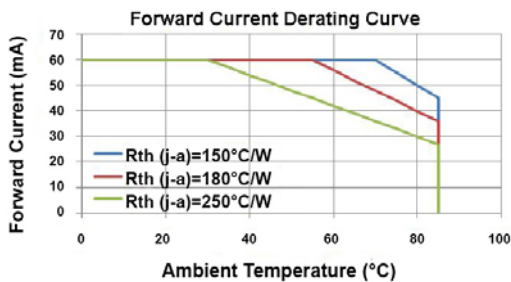
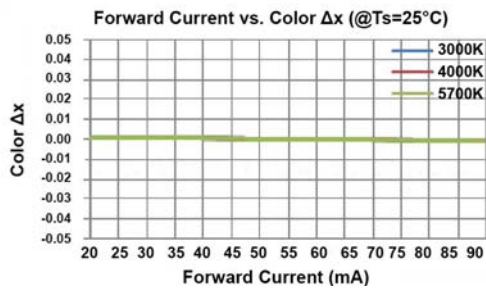
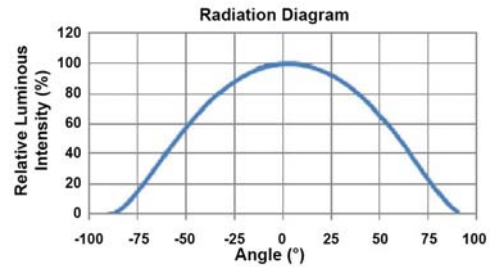
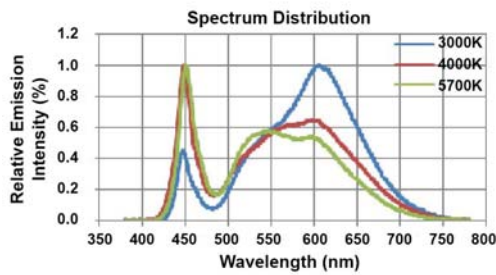
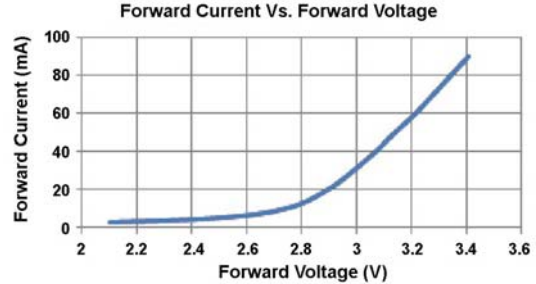
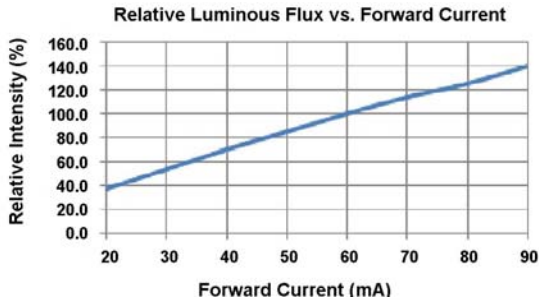

Bivar reserves the right to make changes at any time without notice.

# SURFACE MOUNT LED WHITE, 4014 PACKAGE, 0.2W



## Recommended Soldering Conditions

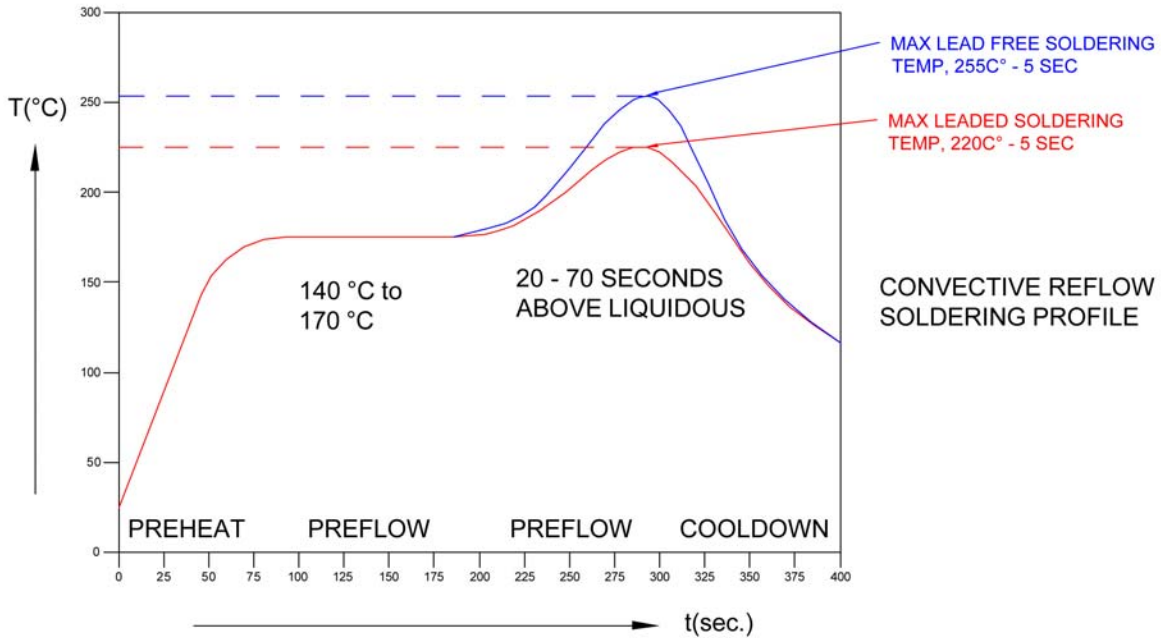

## Tape and Reel Dimensions

Note: 4000 pcs/Reel

### • Dimensions of Tape

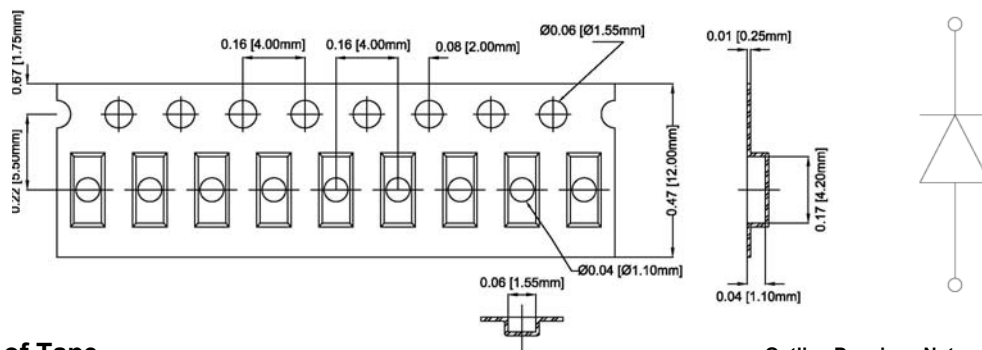

### • Arrangement of Tape

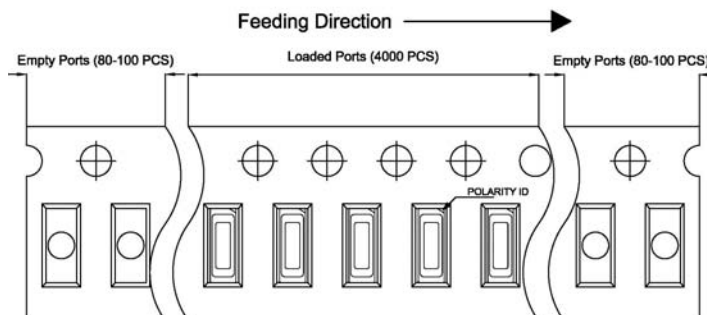

### Outline Drawings Notes:

1. All dimensions are in inches [millimeters].
2. Standard tolerance:  $\pm 0.010$  unless otherwise noted.

Bivar reserves the right to make changes at any time without notice.

# SURFACE MOUNT LED WHITE, 4014 PACKAGE, 0.2W

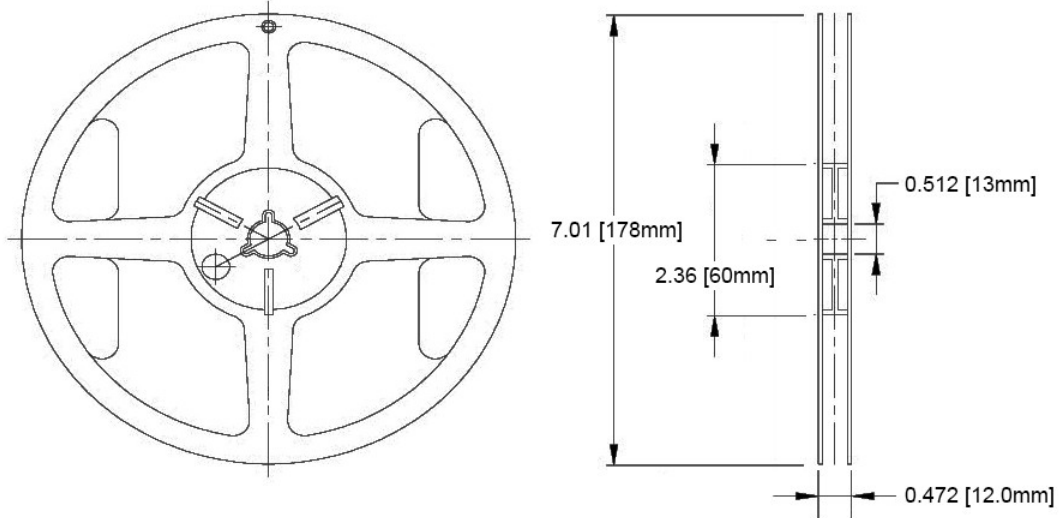

- Outline Drawings Notes:**
1. All dimensions are in inches [millimeters].
  2. Standard tolerance unless otherwise noted: X.XXX ± 0.010"  
X.X ± 0.1"

## Packaging and Labeling Plan

Note: 1 Reel / Bag

Vacuum and Heat Sealed  
ESD/MBB Bag

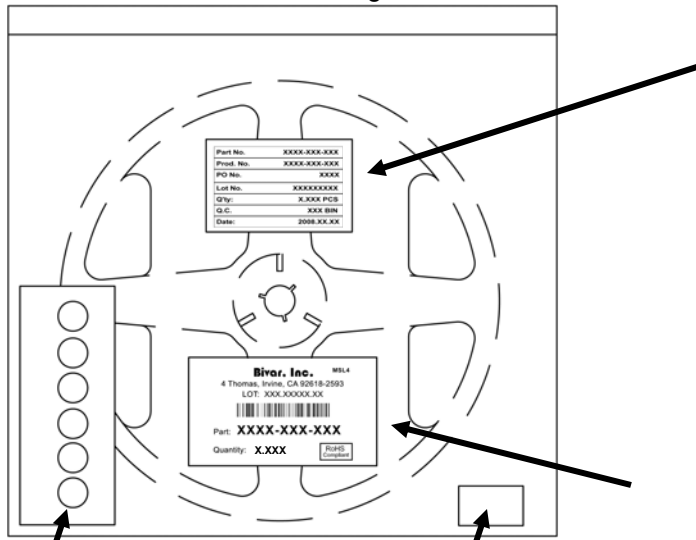

Humidity Indicator Card

Desiccants

Part No.	XXXX-XXX-XXX
Prod. No.	XXXX-XXX-XXX
PO No.	XXXX
Lot No.	XXXXXXXXXX
Q'ty:	X.XXX PCS
Q.C.	XXX BIN
Date:	2008.XX.XX

Internal Quality Control

**Bivar, Inc.** MSL4

4 Thomas, Irvine, CA 92618-2593  
LOT: XXX.XXXXX.XX



Part: **XXXX-XXX-XXX**

Quantity: **X.XXX**

RoHS  
Compliant

Bivar Standard Packaging Label

Bivar reserves the right to make changes at any time without notice.

## Данный компонент на территории Российской Федерации

### Вы можете приобрести в компании MosChip.

Для оперативного оформления запроса Вам необходимо перейти по данной ссылке:

<http://moschip.ru/get-element>

Вы можете разместить у нас заказ для любого Вашего проекта, будь то серийное производство или разработка единичного прибора.

В нашем ассортименте представлены ведущие мировые производители активных и пассивных электронных компонентов.

Нашей специализацией является поставка электронной компонентной базы двойного назначения, продукции таких производителей как XILINX, Intel (ex.ALTERA), Vicor, Microchip, Texas Instruments, Analog Devices, Mini-Circuits, Amphenol, Glenair.

Сотрудничество с глобальными дистрибьюторами электронных компонентов, предоставляет возможность заказывать и получать с международных складов практически любой перечень компонентов в оптимальные для Вас сроки.

На всех этапах разработки и производства наши партнеры могут получить квалифицированную поддержку опытных инженеров.

Система менеджмента качества компании отвечает требованиям в соответствии с ГОСТ Р ИСО 9001, ГОСТ РВ 0015-002 и ЭС РД 009

### Офис по работе с юридическими лицами:

105318, г.Москва, ул.Щербаковская д.3, офис 1107, 1118, ДЦ «Щербаковский»

Телефон: +7 495 668-12-70 (многоканальный)

Факс: +7 495 668-12-70 (доб.304)

E-mail: [info@moschip.ru](mailto:info@moschip.ru)

Skype отдела продаж:

moschip.ru

moschip.ru\_4

moschip.ru\_6

moschip.ru\_9