

1

2

3

4

5

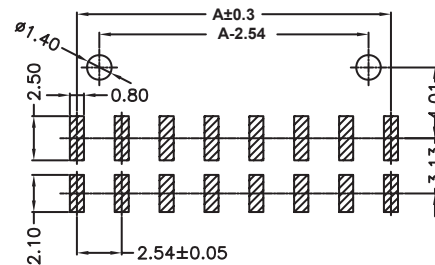
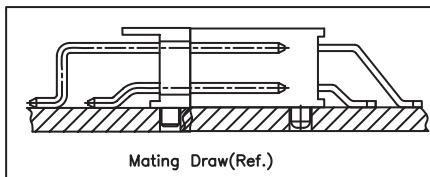

PCB LAYOUT - COMPONENT VIEW

TECHNICAL CHARACTERISTICS

MATERIAL
 INSULATOR: PA 6T
 FLAMABILITY RATING: UL94-V0
 COLOR: BLACK
 CONTACT MATERIAL: COPPER ALLOY
 CONTACT TYPE: STAMPED
 CONTACT PLATING: SELECTIVE GOLD

ENVIRONMENTAL
 OPERATING TEMPERATURE: -40°C UP TO +105°C
 COMPLIANCE: LEAD FREE AND ROHS

ELECTRICAL
 CURRENT RATING: 3A
 WORKING VOLTAGE: 250V AC/DC
 INSULATION RESISTANCE: >1000 MΩ
 WITHSTANDING VOLTAGE: 600 VAC/min
 CONTACT RESISTANCE: 20 mΩ max

SOLDERING
 JEDEC LEAD FREE REFLOW SOLDERING PROCESS

PACKAGING
 TAPE & REEL

DIMENSIONS
 A = 2.54 x (NB PINS/2-1)
 B = (2.54 x NB PINS/2) + 0.5

AVAILABLE IN
 6-8-10-12-14-16-20-22-24-26

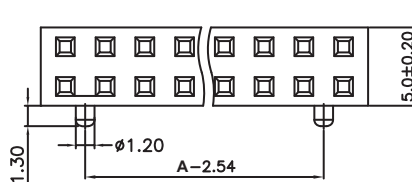
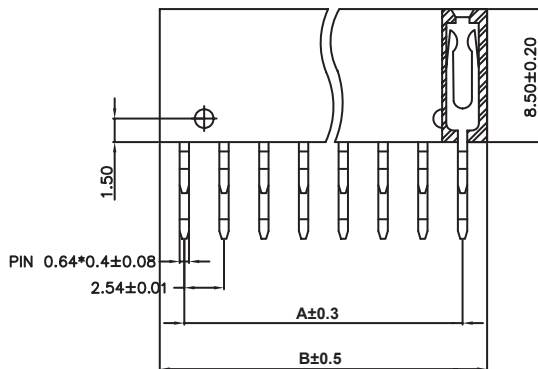
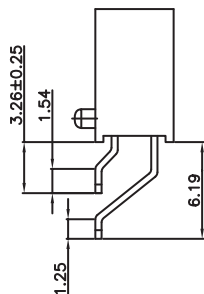

RoHS Compliant

PROJECTION:



GENERAL TOLERANCE

.X = +/- 0.2

.XX = +/- 0.15



APPROVAL: GM

UNIT: MM

SCALE:

SHEET: 1/3

DRAW: AS

DESCRIPTION: WR-PHD - 2.54MM PCB SOCKET HEADER - SMT TYPE
 DOUBLE ROW - RIGHT ANGLE

WERI PART NO: 610 1xx 249 221

SIZE

A4

G				APPROVAL: GM 	UNIT: MM SCALE: SHEET: 1/3 DRAW: AS	DESCRIPTION: WR-PHD - 2.54MM PCB SOCKET HEADER - SMT TYPE DOUBLE ROW - RIGHT ANGLE WERI PART NO: 610 1xx 249 221	SIZE A4
F							
E							
D							
C							
B	08-APR-15	LAYOUT DIM	QL				
A	20-OCT-14	PDF	AS				
REV	DATE	FILE	BY				

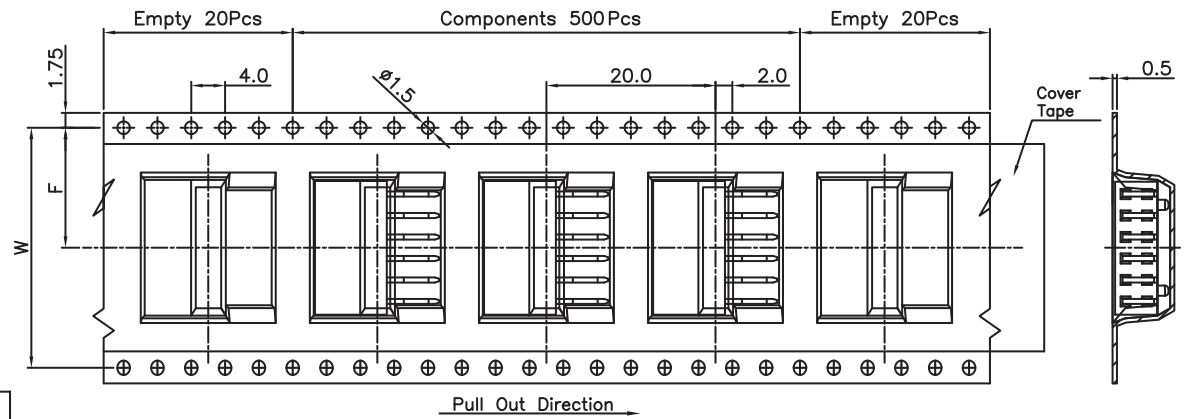
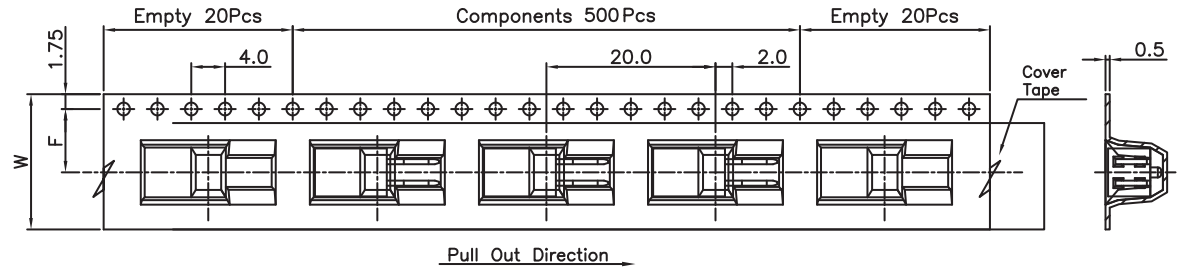
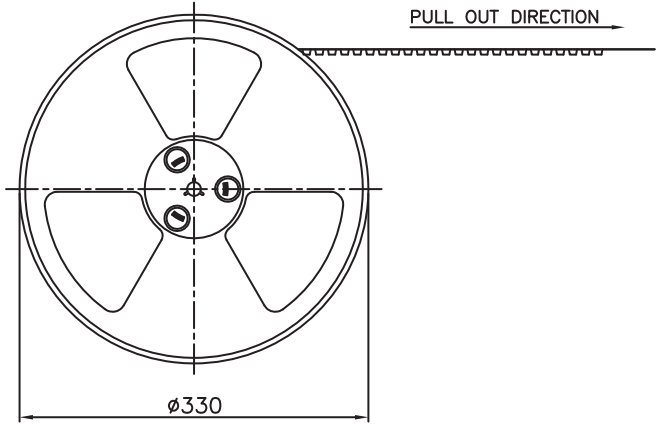
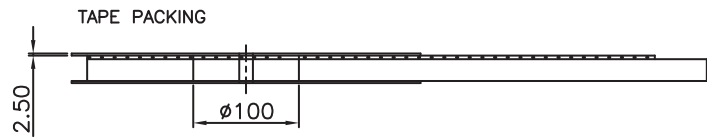

Pin No	W	F	PCS/R	R/CTN	Q'TY
04	16	7.5	500	12	6000
06-10	24	11.5	500	9	4500
12	32	14.2	500	7	3500
14-24	44	20.2	500	5	2500
26-34	56	26.2	500	4	2000
36-40	72	34.2	500	3	1500

RoHS Compliant			
G			
F			
E			
D			
C			
B			
A	20-OCT-14	PDF	AS
REV	DATE	FILE	BY

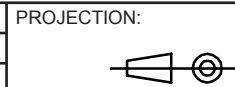

GENERAL TOLERANCE
 .X = +/- 0.2
 .XX = +/- 0.15



APPROVAL: GM

UNIT: MM
 SCALE:
 SHEET: 2/3
 DRAW: AS

DESCRIPTION: WR-PHD - 2.54MM PCB SOCKET HEADER - SMT TYPE
 DOUBLE ROW - RIGHT ANGLE
 WERI PART NO: 610 1xx 249 221

SIZE
A4

1

2

3

4

5

Cautions and Warnings:

This electronic component is designed and developed with the intention for use in general electronics equipments.

Before incorporating the components into any equipments in the field such as aerospace, aviation, nuclear control, submarine, transportation, (automotive control, train control, ship control), transportation signal, disaster prevention, medical, public information network etc. where higher safety and reliability are especially required or if there is possibility of direct damage or injury to human body, Würth Elektronik must be asked for a written approval.



In addition, even electronic component in general electronic equipments, when used in electrical circuits that require high safety, reliability functions or performance, the sufficient reliability evaluation-check for the safety must be performed before by the user before usage.

A

B

C

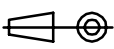
RoHS Compliant

G				PROJECTION: 	GENERAL TOLERANCE .X = +/- 0.2 .XX = +/- 0.15		
F							
E							
D							
C				APPROVAL: JC	UNIT: MM	DESCRIPTION: DISCLAIMER	SIZE A4
B					SCALE:		
A	10-SEP-14	PDF	QL		SHEET: 3/3	WERI PART NO: DISCLAIMER	
REV	DATE	FILE	BY		DRAW: QL		

D

Данный компонент на территории Российской Федерации

Вы можете приобрести в компании MosChip.

Для оперативного оформления запроса Вам необходимо перейти по данной ссылке:

<http://moschip.ru/get-element>

Вы можете разместить у нас заказ для любого Вашего проекта, будь то серийное производство или разработка единичного прибора.

В нашем ассортименте представлены ведущие мировые производители активных и пассивных электронных компонентов.

Нашей специализацией является поставка электронной компонентной базы двойного назначения, продукции таких производителей как XILINX, Intel (ex.ALTERA), Vicor, Microchip, Texas Instruments, Analog Devices, Mini-Circuits, Amphenol, Glenair.

Сотрудничество с глобальными дистрибьюторами электронных компонентов, предоставляет возможность заказывать и получать с международных складов практически любой перечень компонентов в оптимальные для Вас сроки.

На всех этапах разработки и производства наши партнеры могут получить квалифицированную поддержку опытных инженеров.

Система менеджмента качества компании отвечает требованиям в соответствии с ГОСТ Р ИСО 9001, ГОСТ РВ 0015-002 и ЭС РД 009

Офис по работе с юридическими лицами:

105318, г.Москва, ул.Щербаковская д.3, офис 1107, 1118, ДЦ «Щербаковский»

Телефон: +7 495 668-12-70 (многоканальный)

Факс: +7 495 668-12-70 (доб.304)

E-mail: info@moschip.ru

Skype отдела продаж:

moschip.ru

moschip.ru_4

moschip.ru_6

moschip.ru_9