

Distinctive Characteristics

Compact dimensions and low profile allow high density mounting and close stacking of PC boards.

Crisp actuation positively indicates circuit status.

Heat resistant resin allows vapor phase and infrared convection reflow soldering.

Award-winning STC mechanism with benefits unavailable in conventional mechanisms: smoother, positive detent actuation, increased contact stability, and unparalleled logic-level reliability. (Additional STC details in Terms and Acronyms in the Supplement section.)

Insert molded terminals lock out flux, solvents, and other contaminants.

Metric terminal spacing for standard PC board grid (2.0mm x 2.0mm).

Gull-wing terminals provide mechanical stability during soldering and simplified solder joint inspection.

Packaged in tape-reel or partitioned tray. Tape-reel packaging meets EIA-481-D Standard.

Coplanarity: all considered surfaces must lie between two parallel planes that are a maximum distance apart of .0059" (0.15mm). (Additional coplanarity details in Terms and Acronyms in the Supplement section.)



Actual Size

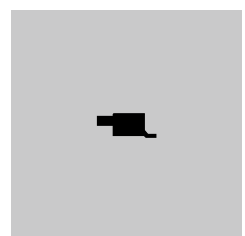

General Specifications

Toggles

Rockers

Pushbuttons

Illuminated PB

Programmable

Keylocks

Rotaries

Slides

Tactiles

Tilt

Touch

Indicators

Accessories

Supplement

Electrical Capacity (Resistive Load)

Logic Level: 0.4VA maximum @ 28V AC/DC maximum
(Applicable Range 0.1mA ~ 0.1A @ 20mV ~ 28V)
Note: Find additional explanation of operating range in Supplement section.

Other Ratings

Contact Resistance: 50 milliohms maximum
Insulation Resistance: 100 megohms minimum @ 500V DC
Dielectric Strength: 500V AC minimum for 1 minute minimum
Mechanical Life: 10,000 operations minimum
Electrical Life: 10,000 operations minimum
Contact Timing: SS312S ~ Shorting (make-before-break); SS314M ~ Nonshorting (break-before-make)
Total Travel: .079" (2.0mm)

Materials & Finishes

Actuator: Polyphenylene sulfide
Housing: Phosphor bronze with tin plating (UL94V-0)
Base: Polyphenylene sulfide (UL94V-0)
Movable Contactor: Phosphor bronze with gold plating over silver plating (code 4)
Terminals: Phosphor bronze with gold plating

Environmental Data

Operating Temp Range: -25°C through +85°C (-13°F through +185°F)
Humidity: 90 ~ 95% humidity for 240 hours @ 40°C (104°F)
Vibration: 10 ~ 55Hz with peak-to-peak amplitude of 1.5mm traversing the frequency range & returning in 1 minute; 3 right angled directions for 2 hours
Shock: 50G (490m/s²) acceleration (tested in 6 right angled directions, with 5 shocks in each direction)

Installation

Soldering: Reflow Soldering Recommended. See Profile A in Supplement section.
Manual Soldering: See Profile A in Supplement section.
Cleaning: These devices are not process sealed. Hand clean locally using alcohol based solution.

Standards & Certifications

Flammability Standards: UL 94V-0 rated housing & base
The SS3 Series slides have not been tested for UL recognition or CSA certification.
These switches are designed for use in a low-voltage, low-current, logic-level circuit.
When used as intended in a logic-level circuit, the results do not produce hazardous energy.

TYPICAL SWITCH ORDERING EXAMPLE

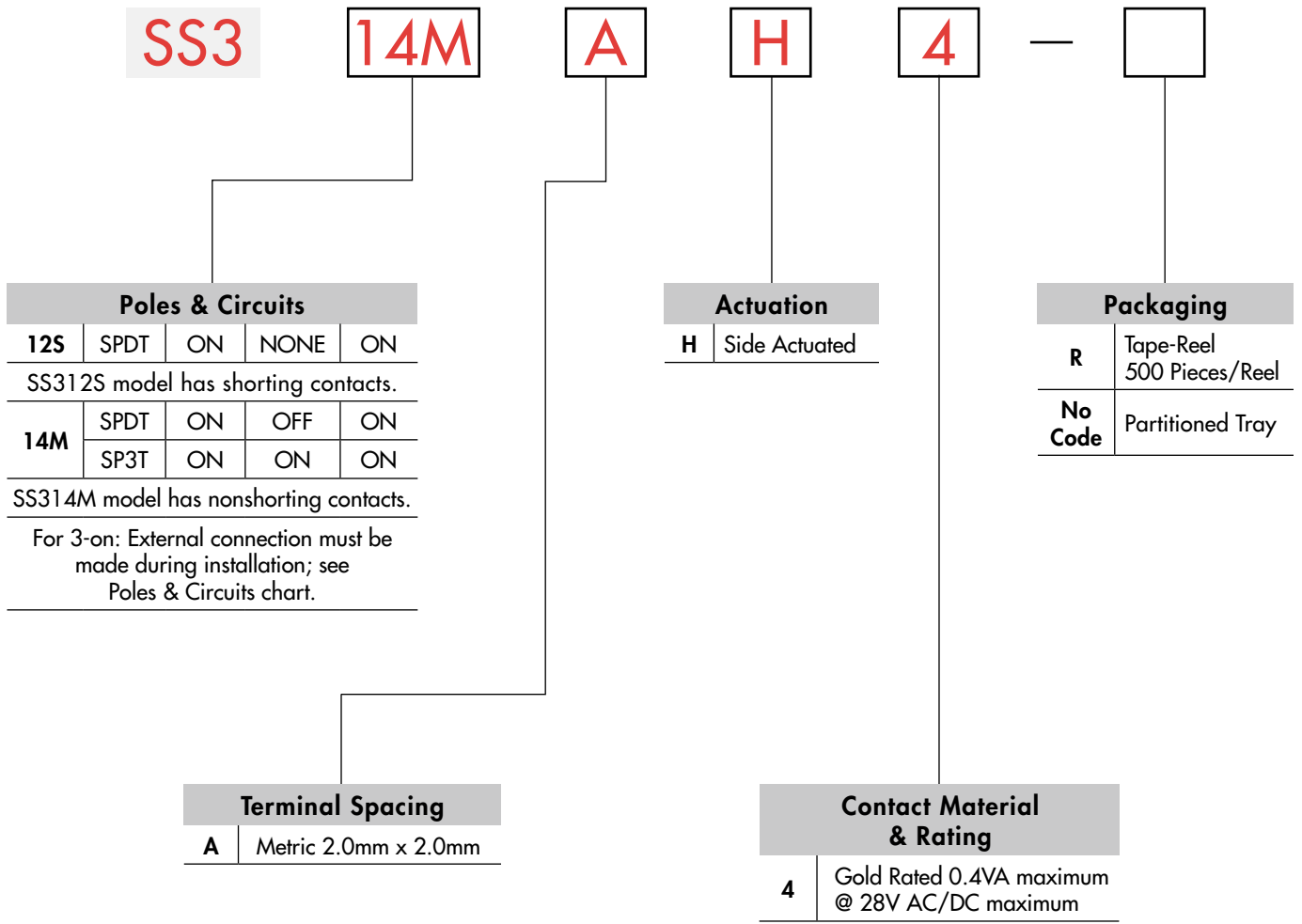

DESCRIPTION FOR TYPICAL ORDERING EXAMPLE

SS314MAH4



Toggle

Rockers

Pushbuttons

Illuminated PB

Programmable

Keylocks

Rotaries

Slides

Tactiles

Tilt

Touch

Indicators

Accessories

Supplement

POLES & CIRCUITS

		Slide Position			Connected Terminals			Throw & Schematics
Pole	Model	Right	Center	Left	Right	Center	Left	Note: Terminal numbers are not actually on switch.
SP	SS312S							
SP	SS314M							SPDT
								SP3T External connection must be made during installation to create ON-ON-ON circuit.

TERMINAL SPACING

A Metric 2.0mm x 2.0mm

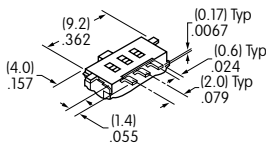

SS312

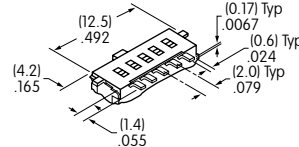
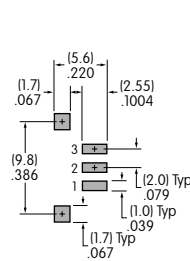

SS314

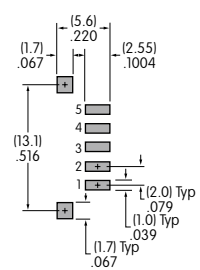

ACTUATION

H Side Actuated

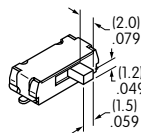

CONTACT MATERIALS & RATING

4 Gold over Silver/Phosphor Bronze Logic Level 0.4VA maximum @ 28V AC/DC maximum

Complete explanation of operating range in Supplement section.

TYPICAL SWITCH DIMENSIONS

Shorting Contacts

Single Pole

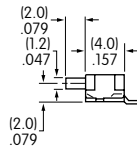
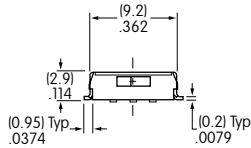
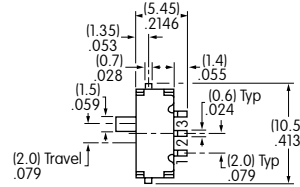

Coplanar Dimension

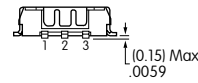

SS312SAH4

Nonshorting Contacts

Single Pole

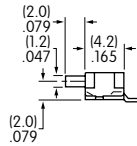
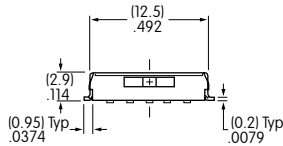
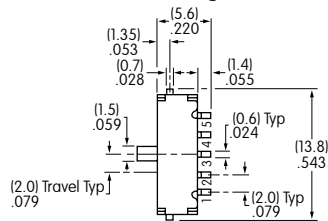

Coplanar Dimension

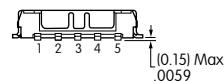

SS314MAH4

PACKAGING

No Code

Partitioned Tray

If the SS3 is ordered in less than 500-piece increments, the switches are packaged in a partitioned tray. No code is required.

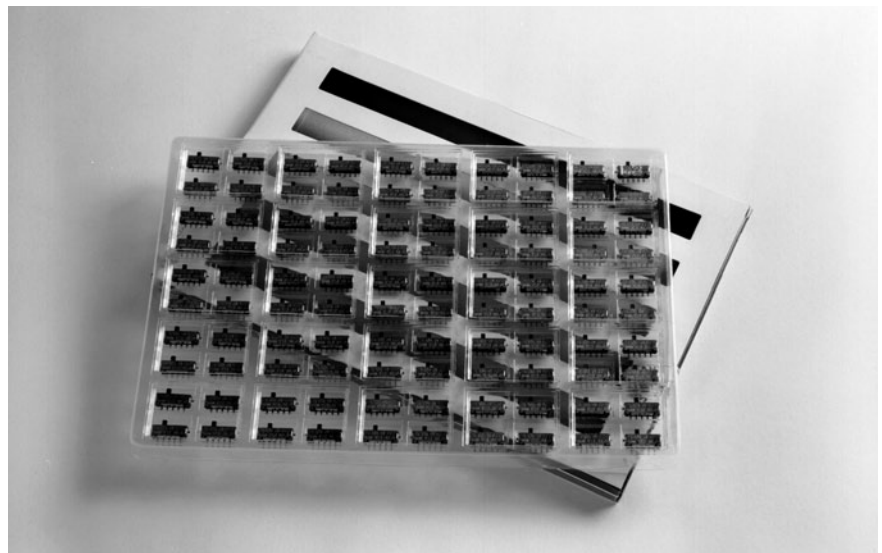

PACKAGING

R

Tape-Reel Packaging

Switches must be ordered in 500-piece increments when tape-reel packaging is selected.

Tape-reel packaging meets EIA-481-D Standard.

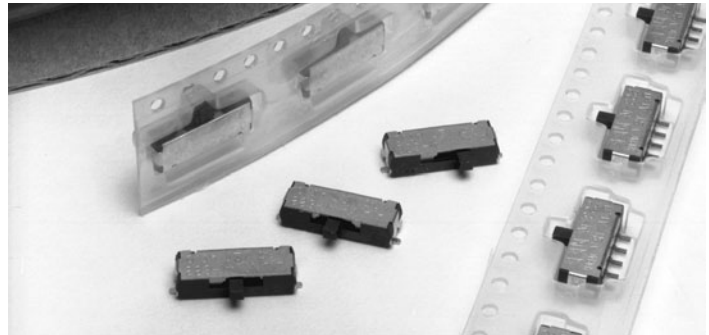

Tape-Reel Packaging for SS312SAH4

Each tape-reel of 530 pockets contains 500 switches.

Minimum Leader Length: 11.97" (304mm) Minimum Trailer Length: 6.93" (176mm)

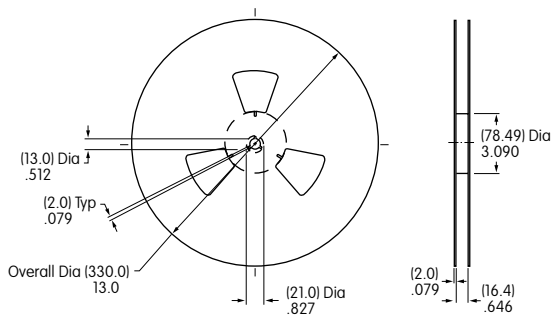

Reel Dimensions

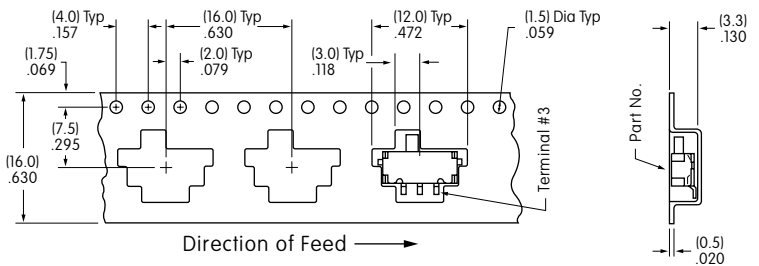

Tape Dimensions

Tape-Reel Packaging for SS314MAH4

Each tape-reel of 530 pockets contains 500 switches.

Minimum Leader Length: 14.96" (380mm) Minimum Trailer Length: 8.66" (220mm)

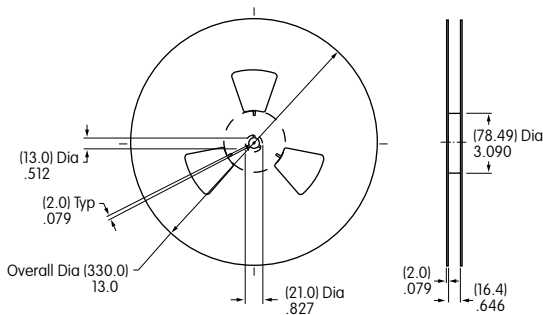

Reel Dimensions

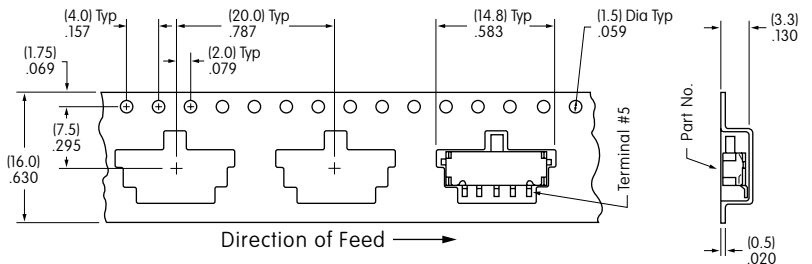

Tape Dimensions

Данный компонент на территории Российской Федерации

Вы можете приобрести в компании MosChip.

Для оперативного оформления запроса Вам необходимо перейти по данной ссылке:

<http://moschip.ru/get-element>

Вы можете разместить у нас заказ для любого Вашего проекта, будь то серийное производство или разработка единичного прибора.

В нашем ассортименте представлены ведущие мировые производители активных и пассивных электронных компонентов.

Нашей специализацией является поставка электронной компонентной базы двойного назначения, продукции таких производителей как XILINX, Intel (ex.ALTERA), Vicor, Microchip, Texas Instruments, Analog Devices, Mini-Circuits, Amphenol, Glenair.

Сотрудничество с глобальными дистрибьюторами электронных компонентов, предоставляет возможность заказывать и получать с международных складов практически любой перечень компонентов в оптимальные для Вас сроки.

На всех этапах разработки и производства наши партнеры могут получить квалифицированную поддержку опытных инженеров.

Система менеджмента качества компании отвечает требованиям в соответствии с ГОСТ Р ИСО 9001, ГОСТ РВ 0015-002 и ЭС РД 009

Офис по работе с юридическими лицами:

105318, г.Москва, ул.Щербаковская д.3, офис 1107, 1118, ДЦ «Щербаковский»

Телефон: +7 495 668-12-70 (многоканальный)

Факс: +7 495 668-12-70 (доб.304)

E-mail: info@moschip.ru

Skype отдела продаж:

moschip.ru

moschip.ru_4

moschip.ru_6

moschip.ru_9