

## Super Junction MOSFET

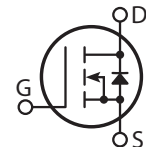
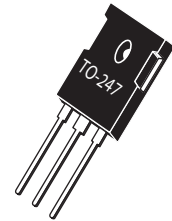

- Ultra Low  $R_{DS(ON)}$
- Low Miller Capacitance
- Ultra Low Gate Charge,  $Q_g$
- Avalanche Energy Rated
- Extreme  $dv/dt$  Rated
- Dual die (parallel)
- Popular T-MAX Package

Unless stated otherwise, Microsemi discrete MOSFETs contain a single MOSFET die. This device is made with two parallel MOSFET die. It is intended for switch-mode operation. It is not suitable for linear mode operation.

### MAXIMUM RATINGS

All Ratings per die:  $T_C = 25^\circ\text{C}$  unless otherwise specified.

Symbol	Parameter	APT36N90BC3G	UNIT
$V_{DSS}$	Drain-Source Voltage	900	Volts
$I_D$	Continuous Drain Current @ $T_C = 25^\circ\text{C}$	36	Amps
	Continuous Drain Current @ $T_C = 100^\circ\text{C}$	23	
$I_{DM}$	Pulsed Drain Current <sup>1</sup>	96	
$V_{GS}$	Gate-Source Voltage Continuous	$\pm 20$	Volts
$P_D$	Total Power Dissipation @ $T_C = 25^\circ\text{C}$	390	Watts
$T_J, T_{STG}$	Operating and Storage Junction Temperature Range	-55 to 150	$^\circ\text{C}$
$T_L$	Lead Temperature: 0.063" from Case for 10 Sec.	260	
$dv/dt$	Drain-Source Voltage slope ( $V_{DS} = 400\text{V}$ , $I_D = 36\text{A}$ , $T_J = 125^\circ\text{C}$ )	50	V/ns
$I_{AR}$	Avalanche Current <sup>2</sup>	8.8	Amps
$E_{AR}$	Repetitive Avalanche Energy <sup>2</sup> ( $I_d = 8.8\text{A}$ , $V_{dd} = 50\text{V}$ )	2.9	mJ
$E_{AS}$	Single Pulse Avalanche Energy ( $I_d = 8.8\text{A}$ , $V_{dd} = 50\text{V}$ )	1940	

### STATIC ELECTRICAL CHARACTERISTICS

Symbol	Characteristic / Test Conditions	MIN	TYP	MAX	UNIT
$BV_{(DSS)}$	Drain-Source Breakdown Voltage ( $V_{GS} = 0\text{V}$ , $I_D = 250\mu\text{A}$ )	900			Volts
$R_{DS(on)}$	Drain-Source On-State Resistance <sup>3</sup> ( $V_{GS} = 10\text{V}$ , $I_D = 18\text{A}$ )		0.10	0.12	Ohms
$I_{DSS}$	Zero Gate Voltage Drain Current ( $V_{DS} = 900\text{V}$ , $V_{GS} = 0\text{V}$ )	-	-	100	$\mu\text{A}$
	Zero Gate Voltage Drain Current ( $V_{DS} = 900\text{V}$ , $V_{GS} = 0\text{V}$ , $T_C = 150^\circ\text{C}$ )	-	50	-	
$I_{GSS}$	Gate-Source Leakage Current ( $V_{GS} = \pm 20\text{V}$ , $V_{DS} = 0\text{V}$ )	-	-	100	nA
$V_{GS(th)}$	Gate Threshold Voltage ( $V_{DS} = V_{GS}$ , $I_D = 2.9\text{mA}$ )	2.5	3	3.5	Volts

 CAUTION: These Devices are Sensitive to Electrostatic Discharge. Proper Handling Procedures Should Be Followed.

"COOLMOS™" comprise a new family of transistors developed by Infineon Technologies AG. "COOLMOS" is a trademark of Infineon Technologies AG."

Microsemi Website - <http://www.microsemi.com>

Symbol	Characteristic	Test Conditions	MIN	TYP	MAX	UNIT
C <sub>iss</sub>	Input Capacitance	V <sub>GS</sub> = 0V V <sub>DS</sub> = 25V f = 1 MHz		7463		pF
C <sub>oss</sub>	Output Capacitance			6827		
C <sub>rss</sub>	Reverse Transfer Capacitance			167		
Q <sub>g</sub>	Total Gate Charge <sup>4</sup>	V <sub>GS</sub> = 10V V <sub>DD</sub> = 450V I <sub>D</sub> = 36A @ 25°C		252		nC
Q <sub>gs</sub>	Gate-Source Charge			38		
Q <sub>gd</sub>	Gate-Drain ("Miller") Charge			112		
t <sub>d(on)</sub>	Turn-on Delay Time	<b>INDUCTIVE SWITCHING</b> V <sub>GS</sub> = 15V V <sub>DD</sub> = 600V I <sub>D</sub> = 36A @ 25°C R <sub>G</sub> = 4.3Ω		70		ns
t <sub>r</sub>	Rise Time			20		
t <sub>d(off)</sub>	Turn-off Delay Time			400		
t <sub>f</sub>	Fall Time			25		
E <sub>on</sub>	Turn-on Switching Energy <sup>5</sup>	<b>INDUCTIVE SWITCHING @ 25°C</b> V <sub>DD</sub> = 600V, V <sub>GS</sub> = 15V I <sub>D</sub> = 36A, R <sub>G</sub> = 4.3Ω		1500		μJ
E <sub>off</sub>	Turn-off Switching Energy			750		
E <sub>on</sub>	Turn-on Switching Energy <sup>5</sup>	<b>INDUCTIVE SWITCHING @ 125°C</b> V <sub>DD</sub> = 600V, V <sub>GS</sub> = 15V I <sub>D</sub> = 36A, R <sub>G</sub> = 4.3Ω		2130		
E <sub>off</sub>	Turn-off Switching Energy			867		

**SOURCE-DRAIN DIODE RATINGS AND CHARACTERISTICS**

Symbol	Characteristic / Test Conditions	MIN	TYP	MAX	UNIT
I <sub>S</sub>	Continuous Source Current (Body Diode)		36		Amps
I <sub>SM</sub>	Pulsed Source Current <sup>1</sup> (Body Diode)		96		Amps
V <sub>SD</sub>	Diode Forward Voltage <sup>3</sup> (V <sub>GS</sub> = 0V, I <sub>S</sub> = 18A)		0.8	1.2	Volts
dv/dt	Peak Diode Recovery <sup>dv/dt</sup> <sup>6</sup>			10	V/ns
t <sub>rr</sub>	Reverse Recovery Time (I <sub>S</sub> = -36A, di/dt = 100A/μs)	T <sub>J</sub> = 25°C		930	ns
		T <sub>J</sub> = 125°C		1230	
Q <sub>rr</sub>	Reverse Recovery Charge (I <sub>S</sub> = -36A, di/dt = 100A/μs)	T <sub>J</sub> = 25°C		35	μC
		T <sub>J</sub> = 125°C		44	
I <sub>RRM</sub>	Peak Recovery Current (I <sub>S</sub> = -36A, di/dt = 100A/μs)	T <sub>J</sub> = 25°C		70	Amps
		T <sub>J</sub> = 125°C		68	

**THERMAL CHARACTERISTICS**

Symbol	Characteristic	MIN	TYP	MAX	UNIT
R <sub>θJC</sub>	Junction to Case			0.3	°C/W
R <sub>θJA</sub>	Junction to Ambient			31	

- 1 Repetitive Rating: Pulse width limited by maximum junction temperature
- 2 Repetitive avalanche causes additional power losses that can be calculated as P<sub>AV</sub> = E<sub>AR</sub>\*f. Pulse width tp limited by Tj max.
- 3 Pulse Test: Pulse width < 380 μs, Duty Cycle < 2%
- 4 See MIL-STD-750 Method 3471
- 5 Eon includes diode reverse recovery.
- 6 Maximum 125°C diode commutation speed = di/dt 600A/μs

Microsemi reserves the right to change, without notice, the specifications and information contained herein.

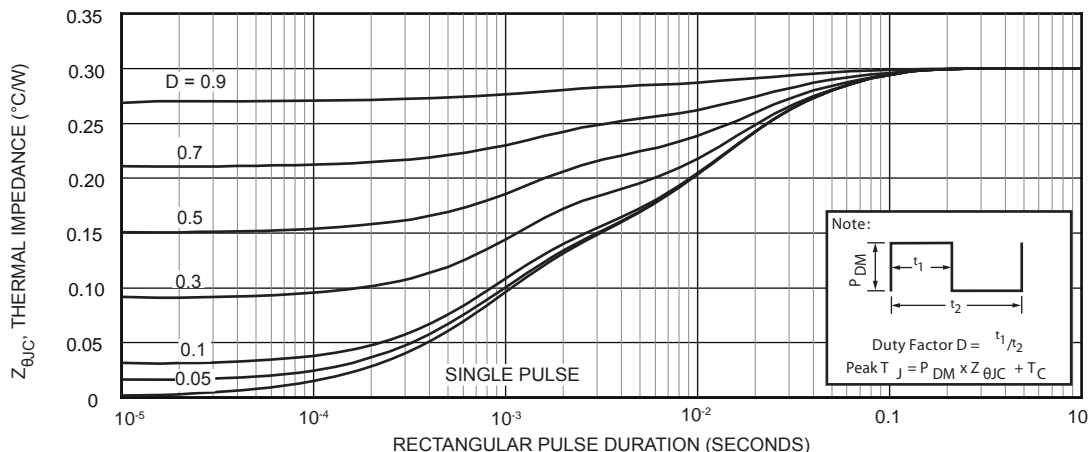

Figure 1, Maximum Effective Transient Thermal Impedance, Junction-To-Case vs Pulse Duration

# Typical Performance Curves

APT36N90BC3G

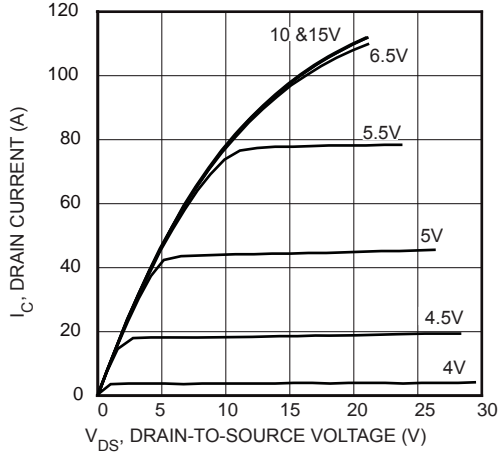

FIGURE 2, Low Voltage Output Characteristics

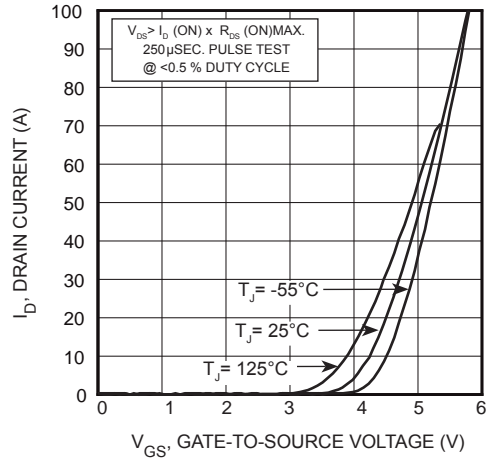

FIGURE 3, Transfer Characteristics

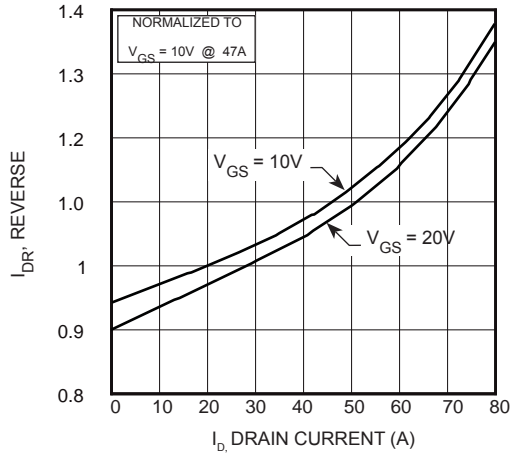

FIGURE 4,  $R_{DS(ON)}$  vs Drain Current

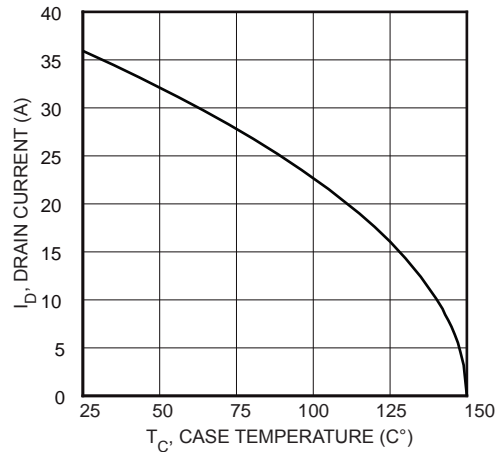

FIGURE 5, Maximum Drain Current vs Case Temperature

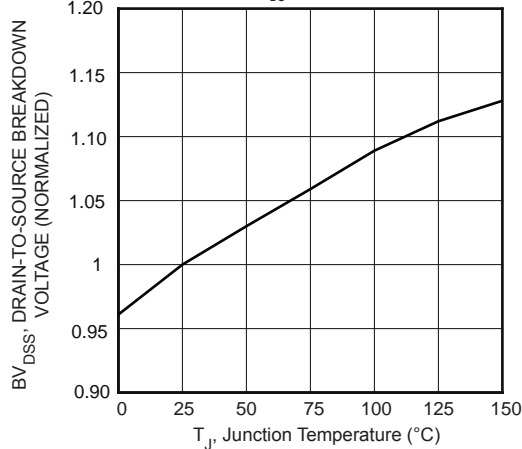

FIGURE 6, Breakdown Voltage vs Temperature

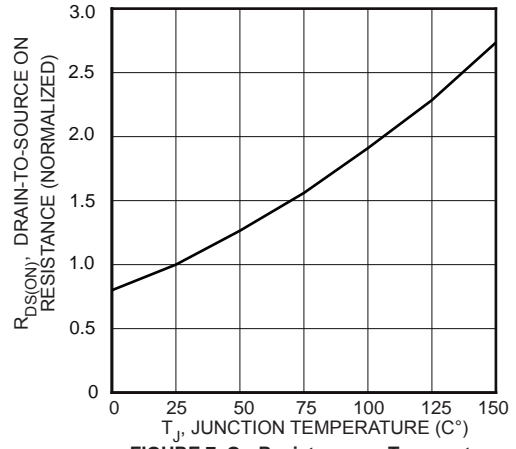

FIGURE 7, On-Resistance vs Temperature

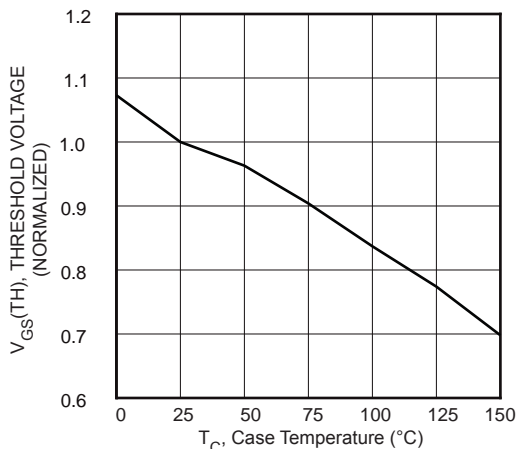

FIGURE 8, Threshold Voltage vs Temperature

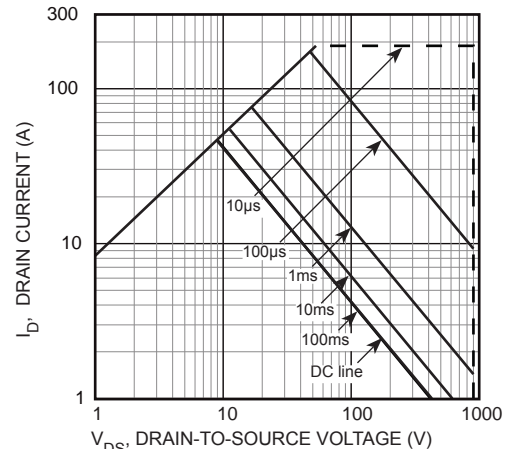

FIGURE 9, Maximum Safe Operating Area

# Typical Performance Curves

APT36N90BC3G

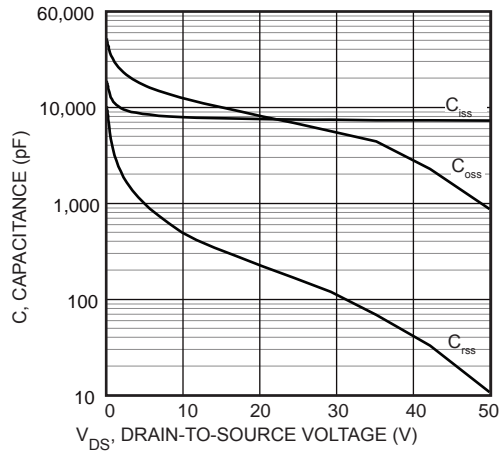

FIGURE 10, Capacitance vs Drain-To-Source Voltage

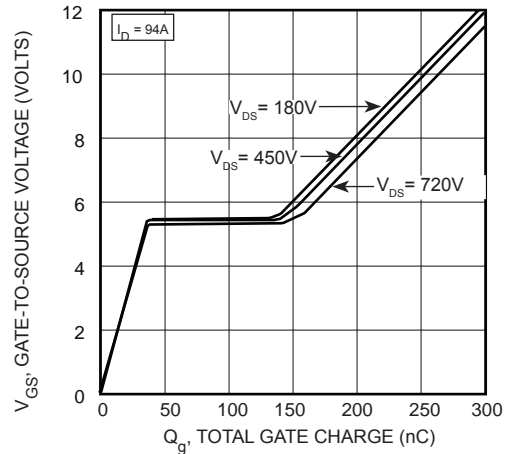

FIGURE 11, Gate Charges vs Gate-To-Source Voltage

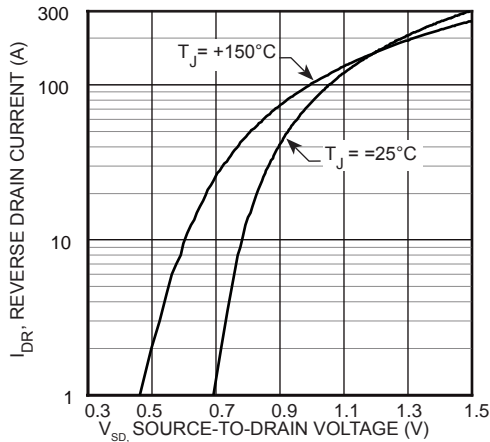

FIGURE 12, Source-Drain Diode Forward Voltage

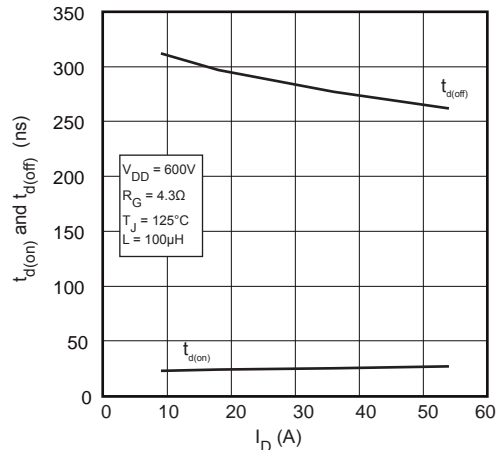

FIGURE 13, Delay Times vs Current

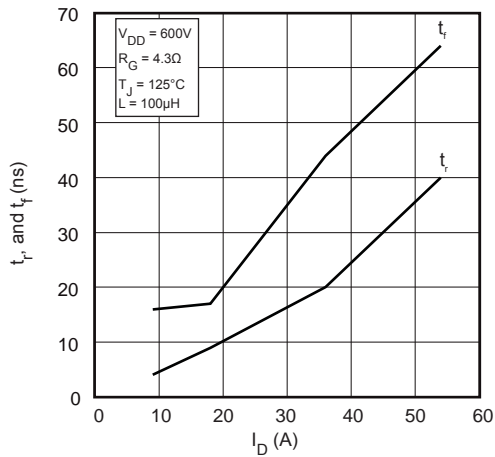

FIGURE 14, Rise and Fall Times vs Current

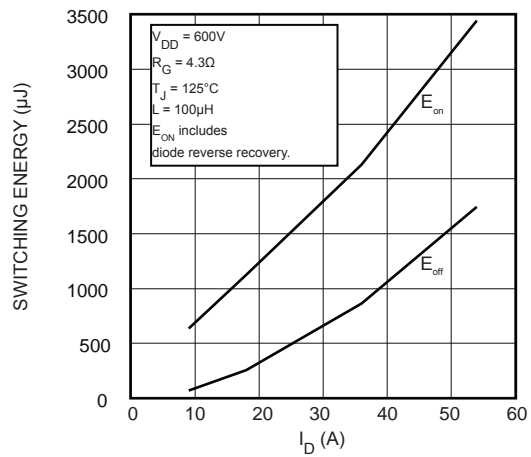

FIGURE 15, Switching Energy vs Current

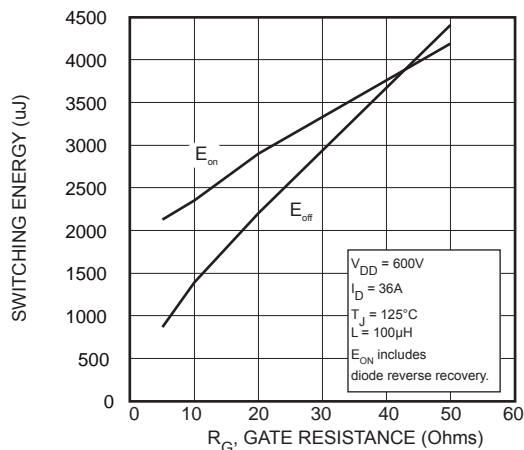

FIGURE 16, Switching Energy vs Gate Resistance

# Typical Performance Curves

APT36N90BC3G

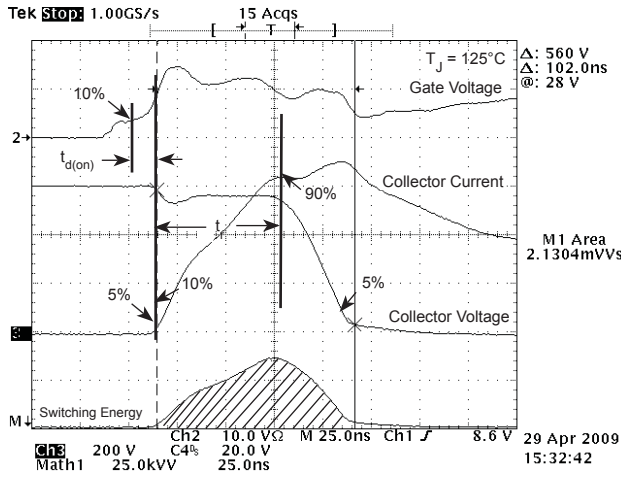

Figure 17, Turn-on Switching Waveforms and Definitions

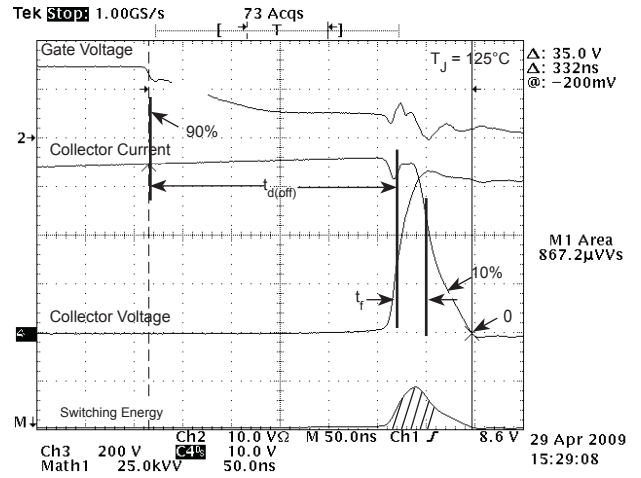

Figure 18, Turn-off Switching Waveforms and Definitions

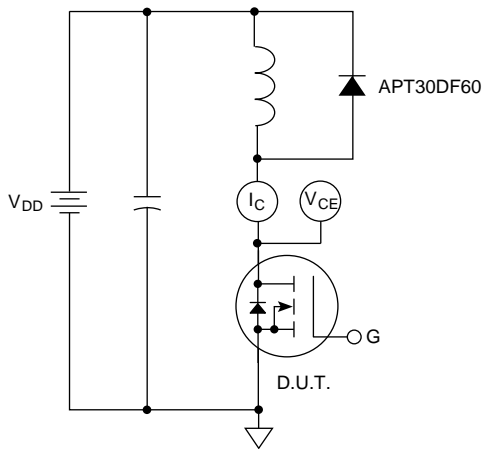
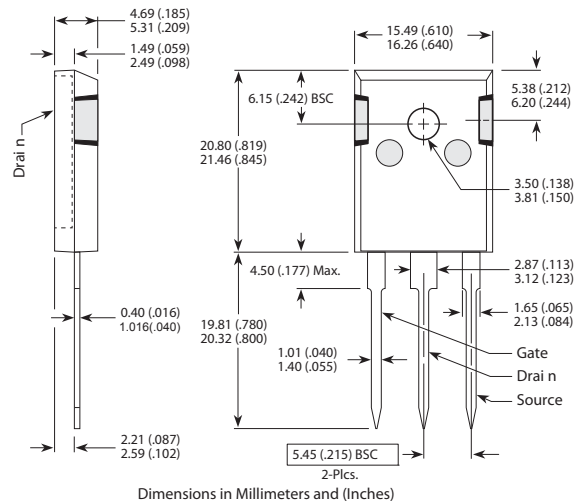

Figure 19, Inductive Switching Test Circuit

## TO-247<sup>®</sup> Package Outline



## Данный компонент на территории Российской Федерации

### Вы можете приобрести в компании MosChip.

Для оперативного оформления запроса Вам необходимо перейти по данной ссылке:

<http://moschip.ru/get-element>

Вы можете разместить у нас заказ для любого Вашего проекта, будь то серийное производство или разработка единичного прибора.

В нашем ассортименте представлены ведущие мировые производители активных и пассивных электронных компонентов.

Нашей специализацией является поставка электронной компонентной базы двойного назначения, продукции таких производителей как XILINX, Intel (ex.ALTERA), Vicor, Microchip, Texas Instruments, Analog Devices, Mini-Circuits, Amphenol, Glenair.

Сотрудничество с глобальными дистрибьюторами электронных компонентов, предоставляет возможность заказывать и получать с международных складов практически любой перечень компонентов в оптимальные для Вас сроки.

На всех этапах разработки и производства наши партнеры могут получить квалифицированную поддержку опытных инженеров.

Система менеджмента качества компании отвечает требованиям в соответствии с ГОСТ Р ИСО 9001, ГОСТ РВ 0015-002 и ЭС РД 009

### Офис по работе с юридическими лицами:

105318, г.Москва, ул.Щербаковская д.3, офис 1107, 1118, ДЦ «Щербаковский»

Телефон: +7 495 668-12-70 (многоканальный)

Факс: +7 495 668-12-70 (доб.304)

E-mail: [info@moschip.ru](mailto:info@moschip.ru)

Skype отдела продаж:

moschip.ru

moschip.ru\_4

moschip.ru\_6

moschip.ru\_9