

# BLCR SERIES LOW VOLTAGE PRESSURE SENSORS

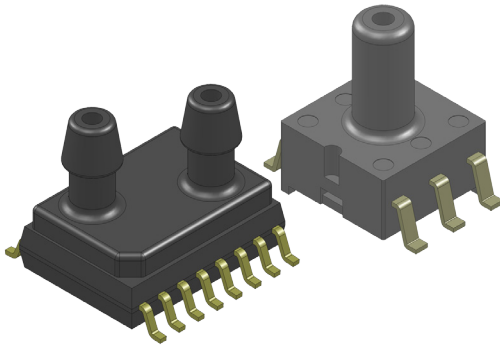

## Features

- 0 to 1 inH2O to 0 to 30 inH2O Pressure Ranges
- Low Supply Voltage (1.8V to 3.3V)
- 0.1% Linearity Typical
- Improved Front to Back Linearity
- Intrinsically No Position Sensitivity
- Improved Warm-Up Shift Distribution
- Parylene Coating Available Upon Request
- Reduced TCO

## Applications

- Medical Instrumentation
- Environmental Controls
- HVAC

## General Description

The BLCR Series Basic Sensor is based on a Dual Die Reference technology to reduce all output offset or common mode errors. It also incorporates All Sensors CoBeam<sup>2</sup> Technology to reduce the overall supply voltage while maintaining comparable output levels to traditional equivalent basic sensing elements. This lower supply voltage gives rise to improved warm-up shift while the CoBeam<sup>2</sup> Technology itself reduces package stress susceptibility resulting in improved overall long term stability. The technology also vastly improves position sensitivity to nearly unmeasurable levels.

This series is intended for use with non-corrosive, non-ionic working fluids such as air, dry gases and the like. The output is also ratio-metric to the supply voltage and is operable from 1.8 to 3.3 volts DC.

## Standard Pressure Ranges

Device	Operating Range	Proof Pressure	Burst Pressure
BLCR-L01D	±1 inH2O (249 Pa)	100 inH2O (25 KPa)	150 inH2O (37 KPa)
BLCR-L05D	±5 inH2O (1,245 Pa)	200 inH2O (50 KPa)	300 inH2O (75 KPa)
BLCR-L10D	±10 inH2O (2,491 Pa)	200 inH2O (50 KPa)	300 inH2O (75 KPa)
BLCR-L20D	±20 inH2O (4,982 Pa)	200 inH2O (50 KPa)	500 inH2O (125 KPa)
BLCR-L30D	±30 inH2O (7,472 Pa)	200 inH2O (50 KPa)	800 inH2O (200 KPa)

Pressure Sensor Maximum Ratings		Environmental Specifications	
Supply Voltage (Vs)	5 Vdc	Temperature Ranges	
Common Mode Pressure	5 psig	Operating	-25 to 85 °C
Lead Temperature (soldering 2-4 sec.)	270 °C	Storage	-40 to 125 °C
		Humidity Limits	0 to 95% RH (non condensing)

## Performance Characteristics for BLCR Series

ALL PARAMETERS ARE MEASURED AT 3.3 VOLT EXCITATION AND ROOM TEMPERATURE UNLESS OTHERWISE SPECIFIED. PRESSURE MEASUREMENTS ARE WITH POSITIVE PRESSURE APPLIED TO PORT B (THE ONLY PORT FOR THE SINGLE PORT CONFIGURATION).

Parameter	Min	Typ	Max	Units	Notes
Output Span (FSS)					4
L01D	4.5	8.0	11.5	mV	
L05D	13.5	24.0	34.5	mV	
L10D	18.0	32.0	46.0	mV	
L20D	22.0	38.0	55.0	mV	
L30D	25.0	42.0	60.0	mV	
Offset Voltage @ Zero Diff. Pressure	-	-	±10.0	mV	-
Offset Temperature Shift (0°C-70°C)	-	±4.0	-	µV/°C	1
Offset Warm-up Shift	-	±10.0	-	µV	2, 6
Offset Position Sensitivity (1g)	-	±0.2	-	µV	-
Linearity, Hysteresis Error	-	0.1	±0.5	%FSS	3
Response Time (10% to 90% Pressure Response)	-	100.0	-	µS	-
Front to Back Linearity	-	0.25	-	%FSS	5
Temperature Effect on Resistance (0°C-70°C)	-	2800	-	ppm/°C	-
Temperature Effect on Span (0°C-70°C)	-	-2000	-	ppm/°C	-
Input Resistance	-	1.7	-	kΩ	-
Output Resistance	-	1.7	-	kΩ	-

### Specification Notes

NOTE 1: SHIFT IS RELATIVE TO 25°C.

NOTE 2: SHIFT IS WITHIN THE FIRST HOUR OF EXCITATION APPLIED TO THE DEVICE.

NOTE 3: MEASURED AT ONE-HALF FULL SCALE RATED PRESSURE USING BEST STRAIGHT LINE CURVE FIT.

NOTE 4: THE SPAN IS THE ALGEBRAIC DIFFERENCE BETWEEN FULL SCALE OUTPUT VOLTAGE AND THE OFFSET VOLTAGE.

NOTE 5: FRONT-BACK LINERITY COMPUTED AS: 
$$Lin_{FB} = \left( \left| \frac{Span_{PortB}}{Span_{PortA}} - 1 \right| \right) \cdot 100\%$$

NOTE 6: TYPICAL WARM UP CHARACTERISTICS AS SHOWN BELOW.

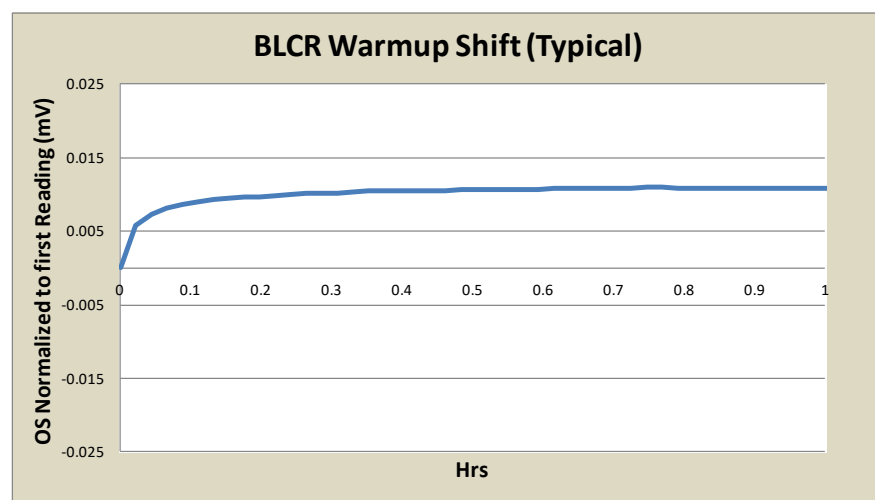

### Soldering Recommendations

- 1) Solder parts as a second operation only.
- 2) Post reflow, wait for 36 hrs before performing any calibration operations.
- 3) Perform spot cleaning as necessary only by hand. DO NOT wash or submerge device in cleaning liquid.



Package Drawings (Cont'd)

D4 Package

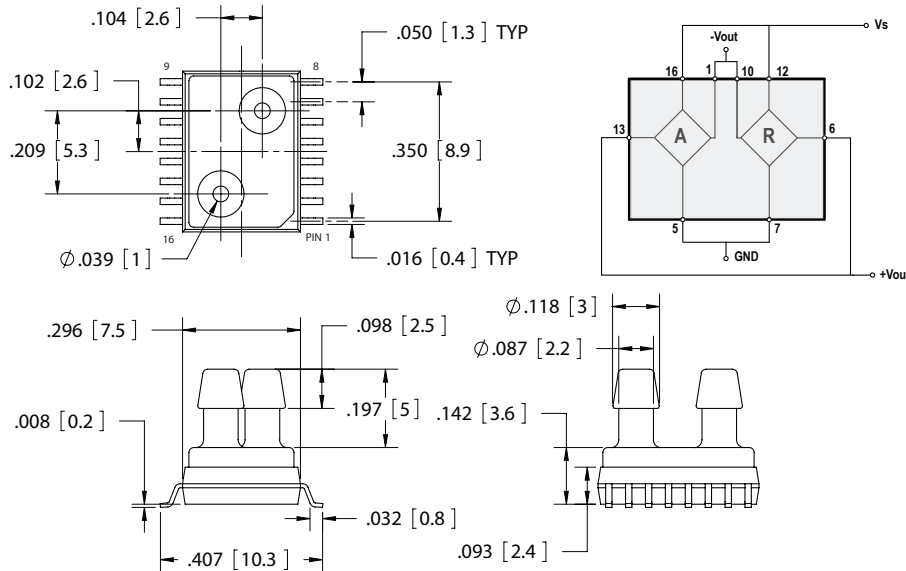

Pin	Definition
1	-OutA
2	N/C
3	N/C
4	N/C
5	GndA
6	-OutR
7	GndR
8	N/C
9	N/C
10	+OutR
11	N/C
12	+VsR
13	+OutA
14	N/C
15	N/C
16	+VsA

NOTES

- 1) Dimensions are in inches [mm].
- 2) Pins 12 and 16 must be connected for Vs input.
- 3) Pins 5 and 7 must be connected for Gnd.
- 4) Pins 1 and 10 must be connected for -Vout.
- 5) Pins 6 and 13 must be connected for +Vout.
- 6) For suggested pad layout, see drawing: PAD-22.

<b>All Sensors</b>	
TITLE:	D-Series Package
SIZE	FILE NAME
<b>A</b>	D4 Package

Package Drawings (Cont'd)

U1 Package

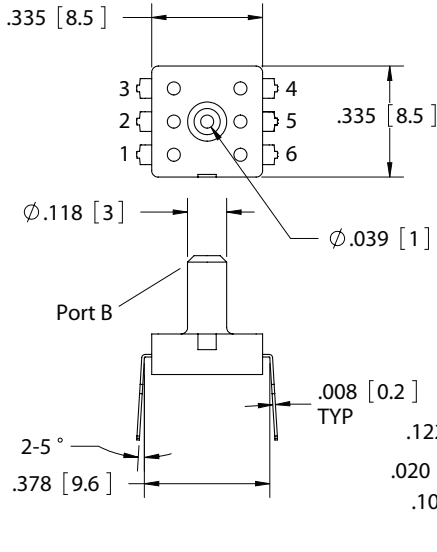

Pin	Definition
1	VsA
2	-Vout
3	VsR
4	-VoutR
5	GND
6	+VoutA

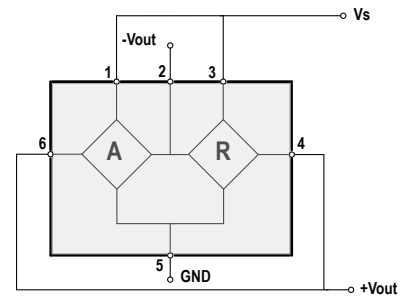

NOTES

- 1) Dimensions are in inches [mm].
- 2) Pins 1 & 3 must be connected for Vs input.
- 3) Pins 4 & 6 must be connected for +Vout output.
- 4) For suggested pad layout, see drawing: PAD-23.

All Sensors

TITLE: U-Series Package

SIZE FILE NAME  
A U1 Package

U2 Package

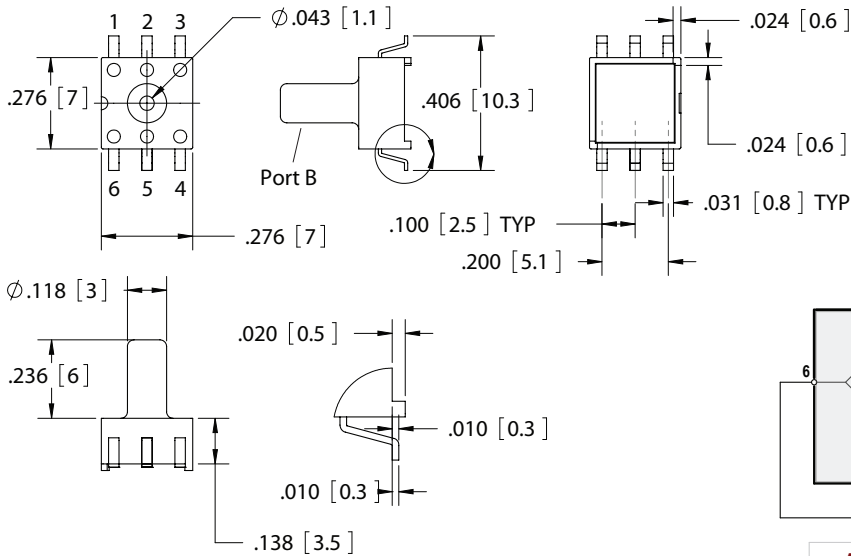

Pin	Definition
1	VsA
2	-Vout
3	VsR
4	-VoutR
5	GND
6	+VoutA

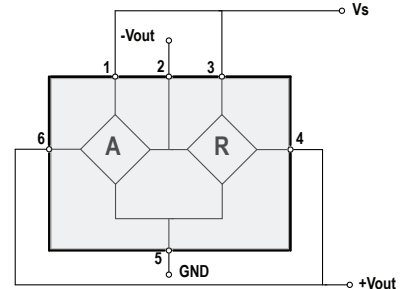

NOTES

- 1) Dimensions are in inches [mm].
- 2) Pins 1 & 3 must be connected for Vs input.
- 3) Pins 4 & 6 must be connected for +Vout output.
- 4) For suggested pad layout, see drawing: PAD-24

All Sensors

TITLE: U-Series Package

SIZE FILE NAME  
A U2 Package

### How To Order

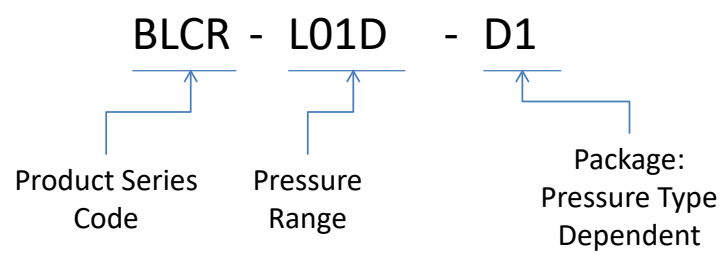

Where:  
Pressure Range (D1, D3, D4 Packages — Differential Only): L01D, L05D, L10D, L20D, L30D  
Pressure Range (U1, U2 Package — Gage Only): L01D, L05D, L10D, L20D, L30D

(Consult with factory for parylene coating)

### Packaging



ALL PRODUCTS FOUND IN THIS DATASHEET ARE PACKAGED IN TUBES WITH PIN 1 ORIENTED TOWARDS THE WHITE STOPPER.

Product Identification (on backside of device)

 <b>All Sensors</b>	Company
<b>BLCR-L01D-D1</b>	Part Number
<b>B12399-09</b>	Wafer Number
<b>R16A24-14</b>	Lot Number

Example shown above.

Pressure Tubing Recommendations

Tubing Number	Part Number	Description
1	ABX00002	Versilic SPX-50, 1/16" I.D. x 1/8" O.D. x 1/32" Wall
2	ABX00004	Versilic SPX-50, 3/32" I.D. x 5/32" O.D. x 1/32" Wall

Package	Tubing Number
D1	1
D3	2
D4	1
U1	2
U2	2

### Suggested Pad Layout

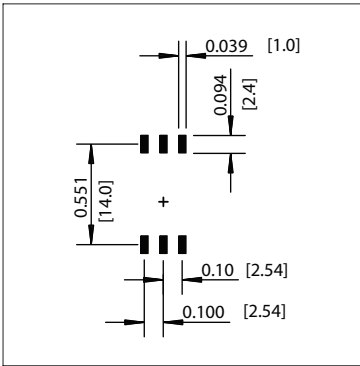

PAD-20

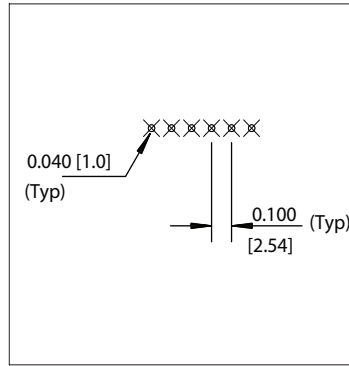

PAD-21

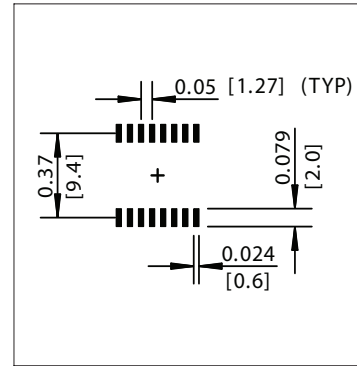

PAD-22

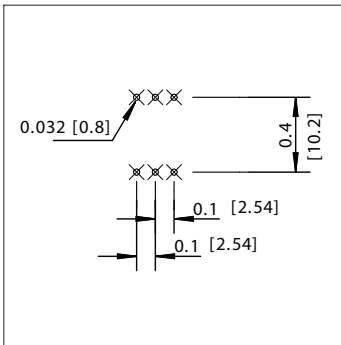

PAD-23

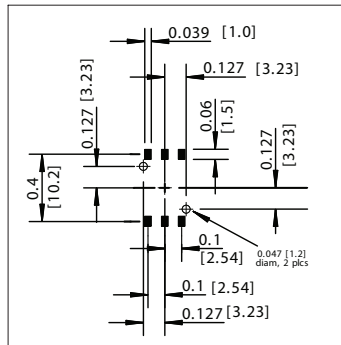

PAD-24

Dimensions are in inches [mm].

All Sensors reserves the right to make changes to any products herein. All Sensors does not assume any liability arising out of the application or use of any product or circuit described herein, neither does it convey any license under its patent rights nor the rights of others.



## Данный компонент на территории Российской Федерации

### Вы можете приобрести в компании MosChip.

Для оперативного оформления запроса Вам необходимо перейти по данной ссылке:

<http://moschip.ru/get-element>

Вы можете разместить у нас заказ для любого Вашего проекта, будь то серийное производство или разработка единичного прибора.

В нашем ассортименте представлены ведущие мировые производители активных и пассивных электронных компонентов.

Нашей специализацией является поставка электронной компонентной базы двойного назначения, продукции таких производителей как XILINX, Intel (ex.ALTERA), Vicor, Microchip, Texas Instruments, Analog Devices, Mini-Circuits, Amphenol, Glenair.

Сотрудничество с глобальными дистрибьюторами электронных компонентов, предоставляет возможность заказывать и получать с международных складов практически любой перечень компонентов в оптимальные для Вас сроки.

На всех этапах разработки и производства наши партнеры могут получить квалифицированную поддержку опытных инженеров.

Система менеджмента качества компании отвечает требованиям в соответствии с ГОСТ Р ИСО 9001, ГОСТ РВ 0015-002 и ЭС РД 009

### Офис по работе с юридическими лицами:

105318, г.Москва, ул.Щербаковская д.3, офис 1107, 1118, ДЦ «Щербаковский»

Телефон: +7 495 668-12-70 (многоканальный)

Факс: +7 495 668-12-70 (доб.304)

E-mail: [info@moschip.ru](mailto:info@moschip.ru)

Skype отдела продаж:

moschip.ru

moschip.ru\_4

moschip.ru\_6

moschip.ru\_9