

Optocoupler, Phototransistor Output, with Base Connection, 110 °C Rated

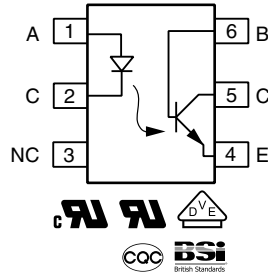

FEATURES

- Operating temperature from -55 °C to +110 °C
- Breakdown voltage, 5000 V_{RMS}
- Long term stability
- Industry standard dual-in-line package
- Material categorization:
For definitions of compliance please see www.vishay.com/doc?99912

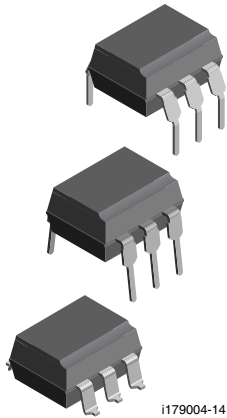

RoHS
COMPLIANT

APPLICATIONS

- AC adapter
- SMPS
- PLC
- Factory automation
- Game consoles

AGENCY APPROVALS

Safety application model number covering all products in this datasheet is CNY117. This model number should be used when consulting safety agency documents.

- UL file no. E52744
- cUL tested to CSA 22.2 bulletin 5A
- DIN EN 60747-5-5 (VDE 0884-5), available with option 1
- BSI: EN 60065, EN 60950-1
- CQC GB8898-2011

DESCRIPTION

The CNY117 is a 110 °C rated optocoupler consisting of a gallium arsenide infrared emitting diode optically coupled to a silicon planar phototransistor detector in a plastic plug-in DIP-6 package.

The coupling device is suitable for signal transmission between two electrically separated circuits. The potential difference between the circuits to be coupled is not allowed to exceed the maximum permissible reference voltages.

ORDERING INFORMATION

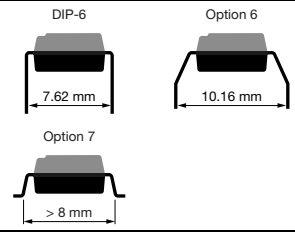
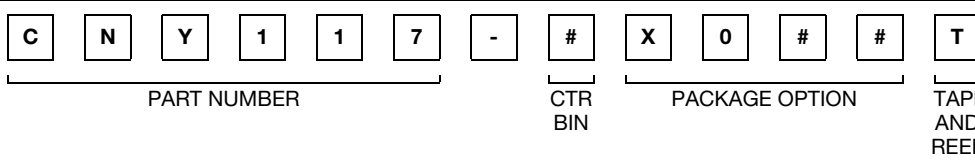

| AGENCY CERTIFIED/PACKAGE | CTR (%) | | | |
|--------------------------|---------------|---------------|---------------|---------------|
| | 40 to 80 | 63 to 125 | 100 to 200 | 160 to 320 |
| UL, cUL, BSI | | | | |
| DIP-6 | CNY117-1 | CNY117-2 | CNY117-3 | CNY117-4 |
| DIP-6, 400 mil, option 6 | CNY117-1X006 | CNY117-2X006 | CNY117-3X006 | CNY117-4X006 |
| SMD-6, option 7 | CNY117-1X007T | CNY117-2X007T | CNY117-3X007T | CNY117-4X007T |
| VDE, UL, cUL, BSI | | | | |
| DIP-6 | CNY117-1X001 | CNY117-2X001 | CNY117-3X001 | CNY117-4X001 |
| DIP-6, 400 mil, option 6 | CNY117-1X016 | CNY117-2X016 | CNY117-3X016 | CNY117-4X016 |
| SMD-6, option 7 | CNY117-1X017T | CNY117-2X017T | CNY117-3X017T | CNY117-4X017T |

Note

- Additional options may be possible, please contact sales office.



| ABSOLUTE MAXIMUM RATINGS (T _{amb} = 25 °C, unless otherwise specified) | | | | |
|--|---|-------------------|-------------|------------------|
| PARAMETER | TEST CONDITION | SYMBOL | VALUE | UNIT |
| INPUT | | | | |
| Reverse voltage | | V _R | 6.0 | V |
| DC forward current | | I _F | 60 | mA |
| Surge forward current | t ≤ 10 μs | I _{FSM} | 2.5 | A |
| Power dissipation | | P _{diss} | 100 | mW |
| OUTPUT | | | | |
| Collector emitter breakdown voltage | | BV _{CEO} | 70 | V |
| Collector current | | I _C | 50 | mA |
| Collector peak current | t _p /T = 0.5, t _p ≤ 10 ms | I _{CM} | 100 | mA |
| Output power dissipation | | P _{diss} | 150 | mW |
| COUPLER | | | | |
| Isolation test voltage between emitter and detector referred to standard climate 23/50 DIN 50014 | t = 1 min | V _{ISO} | 5000 | V _{RMS} |
| Storage temperature range | | T _{stg} | -55 to +150 | °C |
| Ambient temperature range | | T _{amb} | -55 to +110 | °C |
| Soldering temperature ⁽¹⁾ | 2 mm from case, ≤ 10 s | T _{sld} | 260 | °C |
| Total power dissipation | | P _{diss} | 250 | mW |

Notes

- Stresses in excess of the absolute maximum ratings can cause permanent damage to the device. Functional operation of the device is not implied at these or any other conditions in excess of those given in the operational sections of this document. Exposure to absolute maximum ratings for extended periods of the time can adversely affect reliability.
- ⁽¹⁾ Refer to reflow profile for soldering conditions for surface mounted devices (SMD). Refer to wave profile for soldering conditions for through hole devices (DIP).

| ELECTRICAL CHARACTERISTICS (T _{amb} = 25 °C, unless otherwise specified) | | | | | | | |
|---|---|----------|--------------------|------|------|------|------|
| PARAMETER | TEST CONDITION | PART | SYMBOL | MIN. | TYP. | MAX. | UNIT |
| INPUT | | | | | | | |
| Forward voltage | I _F = 60 mA | | V _F | | 1.39 | 1.65 | V |
| Breakdown voltage | I _R = 10 μA | | V _{BR} | 6 | | | V |
| Reverse current | V _R = 6 V | | I _R | | 0.01 | 10 | μA |
| Capacitance | V _R = 0 V, f = 1 MHz | | C _O | | 25 | | pF |
| OUTPUT | | | | | | | |
| Collector emitter capacitance | V _{CE} = 5 V, f = 1 MHz | | C _{CE} | | 5.2 | | pF |
| Base collector capacitance | V _{CE} = 5 V, f = 1 MHz | | C _{BC} | | 6.5 | | pF |
| Emitter base capacitance | V _{CE} = 5 V, f = 1 MHz | | C _{EB} | | 7.5 | | pF |
| COUPLER | | | | | | | |
| Collector emitter, saturation voltage | I _F = 10 mA, I _C = 2.5 mA | | V _{CEsat} | | 0.25 | 0.4 | V |
| Coupling capacitance | | | C _C | | 0.6 | | pF |
| Collector emitter, leakage current | V _{CE} = 10 V | CNY117-1 | I _{CEO} | | 2.0 | 50 | nA |
| | | CNY117-2 | I _{CEO} | | 2.0 | 50 | nA |
| | | CNY117-3 | I _{CEO} | | 5.0 | 100 | nA |
| | | CNY117-4 | I _{CEO} | | 5.0 | 100 | nA |

Note

- Minimum and maximum values were tested requirements. Typical values are characteristics of the device and are the result of engineering evaluations. Typical values are for information only and are not part of the testing requirements.



| CURRENT TRANSFER RATIO ($T_{amb} = 25\text{ }^{\circ}\text{C}$, unless otherwise specified) | | | | | | | |
|--|-----------------------|----------|--------|------|------|------|------|
| PARAMETER | TEST CONDITION | PART | SYMBOL | MIN. | TYP. | MAX. | UNIT |
| Current transfer ratio | $I_F = 10\text{ mA}$ | CNY117-1 | CTR | 40 | | 80 | % |
| | | CNY117-2 | CTR | 63 | | 125 | % |
| | | CNY117-3 | CTR | 100 | | 200 | % |
| | | CNY117-4 | CTR | 160 | | 320 | % |
| | $I_F = 1.0\text{ mA}$ | CNY117-1 | CTR | 13 | 30 | | % |
| | | CNY117-2 | CTR | 22 | 45 | | % |
| | | CNY117-3 | CTR | 34 | 70 | | % |
| | | CNY117-4 | CTR | 56 | 90 | | % |

Note

- Current transfer ratio I_C/I_F at $V_{CE} = 5.0\text{ V}$, $25\text{ }^{\circ}\text{C}$ and collector emitter leakage current by dash number.

| SWITCHING CHARACTERISTICS ($T_{amb} = 25\text{ }^{\circ}\text{C}$, unless otherwise specified) | | | | | | | |
|---|---|----------|-----------|------|------|------|---------------|
| PARAMETER | TEST CONDITION | PART | SYMBOL | MIN. | TYP. | MAX. | UNIT |
| LINEAR OPERATION (without saturation) | | | | | | | |
| Turn-on time | $I_F = 10\text{ mA}$, $V_{CC} = 5.0\text{ V}$, $R_L = 75\text{ }\Omega$ | | t_{on} | | 3.0 | | μs |
| Rise time | $I_F = 10\text{ mA}$, $V_{CC} = 5.0\text{ V}$, $R_L = 75\text{ }\Omega$ | | t_r | | 2.0 | | μs |
| Turn-off time | $I_F = 10\text{ mA}$, $V_{CC} = 5.0\text{ V}$, $R_L = 75\text{ }\Omega$ | | t_{off} | | 2.3 | | μs |
| Fall time | $I_F = 10\text{ mA}$, $V_{CC} = 5.0\text{ V}$, $R_L = 75\text{ }\Omega$ | | t_f | | 2.0 | | μs |
| Cut-off frequency | $I_F = 10\text{ mA}$, $V_{CC} = 5.0\text{ V}$, $R_L = 75\text{ }\Omega$ | | f_{CO} | | 110 | | kHz |
| SWITCHING OPERATION (with saturation) | | | | | | | |
| Turn-on time | $I_F = 20\text{ mA}$ | CNY117-1 | t_{on} | | 3.0 | | μs |
| | $I_F = 10\text{ mA}$ | CNY117-2 | t_{on} | | 4.2 | | μs |
| | | CNY117-3 | t_{on} | | 4.2 | | μs |
| | $I_F = 5.0\text{ mA}$ | CNY117-4 | t_{on} | | 6.0 | | μs |
| Rise time | $I_F = 20\text{ mA}$ | CNY117-1 | t_r | | 2.0 | | μs |
| | $I_F = 10\text{ mA}$ | CNY117-2 | t_r | | 3.0 | | μs |
| | | CNY117-3 | t_r | | 3.0 | | μs |
| | $I_F = 5.0\text{ mA}$ | CNY117-4 | t_r | | 4.6 | | μs |
| Turn-off time | $I_F = 20\text{ mA}$ | CNY117-1 | t_{off} | | 18 | | μs |
| | $I_F = 10\text{ mA}$ | CNY117-2 | t_{off} | | 23 | | μs |
| | | CNY117-3 | t_{off} | | 23 | | μs |
| | $I_F = 5.0\text{ mA}$ | CNY117-4 | t_{off} | | 25 | | μs |
| Fall time | $I_F = 20\text{ mA}$ | CNY117-1 | t_f | | 11 | | μs |
| | $I_F = 10\text{ mA}$ | CNY117-2 | t_f | | 14 | | μs |
| | | CNY117-3 | t_f | | 14 | | μs |
| | $I_F = 5.0\text{ mA}$ | CNY117-4 | t_f | | 15 | | μs |

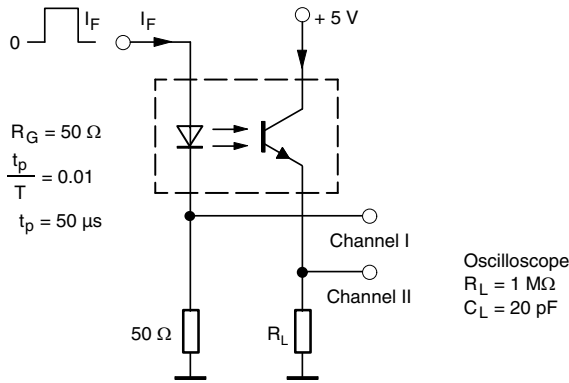

95 10804-3

Fig. 1 - Test Circuit, Non-Saturated Operation

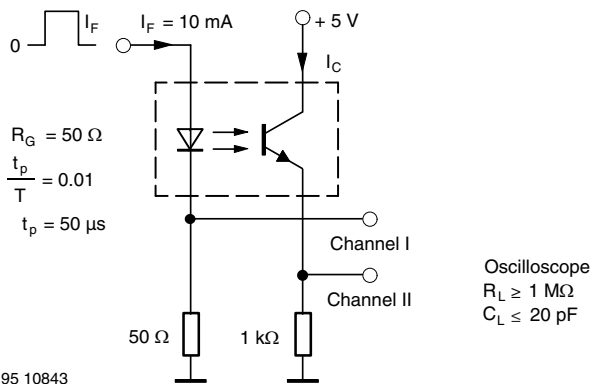

95 10843

Fig. 2 - Test Circuit, Saturated Operation

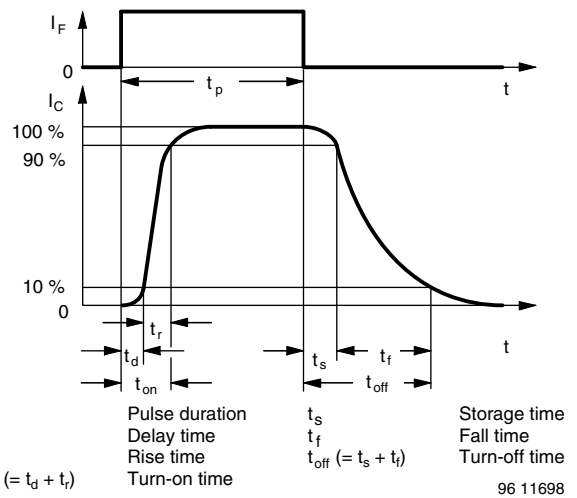

Fig. 3 - Switching Times

96 11698

| SAFETY AND INSULATION RATINGS | | | | |
|--|--|-------------------|--------------------|-------------------|
| PARAMETER | | SYMBOL | VALUE | UNIT |
| MAXIMUM SAFETY RATINGS | | | | |
| Output safety power | | P _{SO} | 700 | mW |
| Input safety current | | I _{SI} | 400 | mA |
| Safety temperature | | T _{SI} | 175 | °C |
| Comparative tracking index | | CTI | 175 | |
| INSULATION RATED PARAMETERS | | | | |
| Maximum withstanding isolation voltage | | V _{ISO} | 5000 | V _{RMS} |
| Maximum transient isolation voltage | | V _{IOTM} | 8000 | V _{peak} |
| Maximum repetitive peak isolation voltage | | V _{IORM} | 890 | V _{peak} |
| Insulation resistance | T _{amb} = 25 °C, V _{DC} = 500 V | R _{IO} | ≥ 10 ¹² | Ω |
| Insulation resistance | T _{amb} = 100 °C, V _{DC} = 500 V | R _{IO} | ≥ 10 ¹¹ | Ω |
| Climatic classification (according to IEC 68 part 1) | | | 55/115/21 | |
| Environment (pollution degree in accordance to DIN VDE 0109) | | | 2 | |
| Creepage distance | Standard DIP-4 | | ≥ 7 | mm |
| | SMD | | ≥ 7 | mm |
| Clearance distance | Standard DIP-4 | | ≥ 8 | mm |
| | SMD | | ≥ 8 | mm |
| Insulation thickness | | DTI | ≥ 0.4 | mm |

Note

- As per DIN EN 60747-5-5, § 7.4.3.8.2, this optocoupler is suitable for “safe electrical insulation” only within the safety ratings. Compliance with the safety ratings shall be ensured by means of protective circuits.

TYPICAL CHARACTERISTICS ($T_{amb} = 25\text{ }^{\circ}\text{C}$, unless otherwise specified)

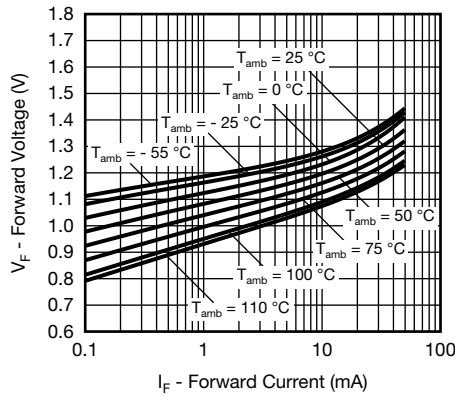

Fig. 4 - Forward Voltage vs. Forward Current

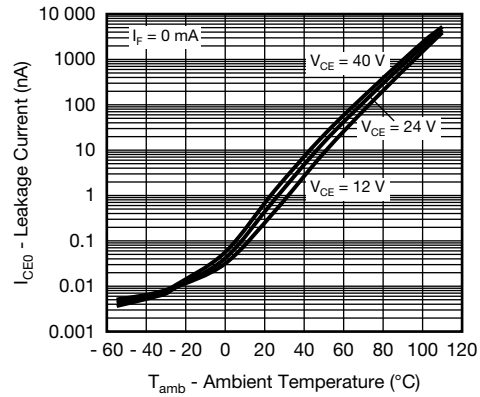

Fig. 7 - Leakage Current vs. Ambient Temperature

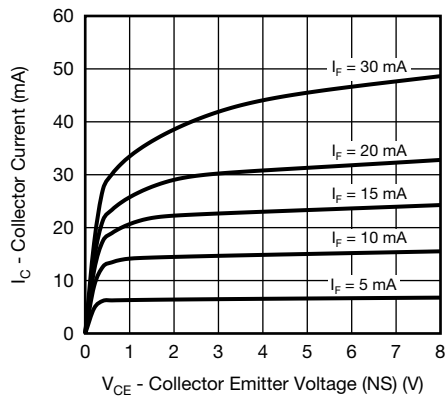

Fig. 5 - Collector Current vs. Collector Emitter Voltage (NS)

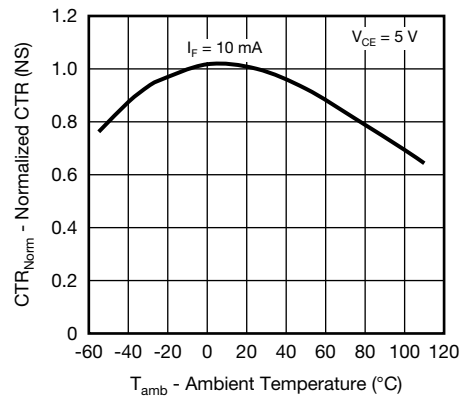

Fig. 8 - Normalized CTR (NS) vs. Ambient Temperature

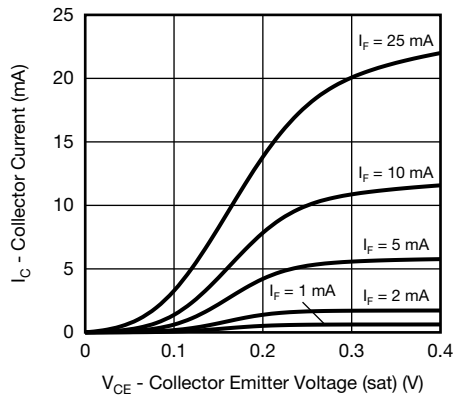

Fig. 6 - Collector Current vs. Collector Emitter Voltage (sat)

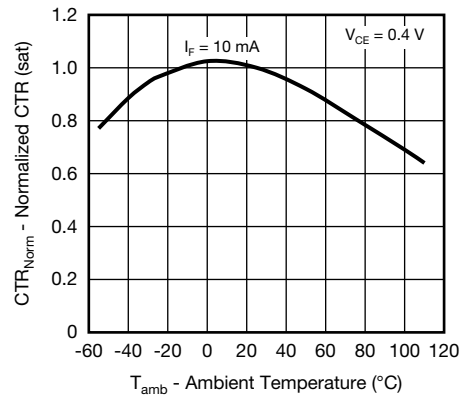

Fig. 9 - Normalized CTR (sat) vs. Ambient Temperature

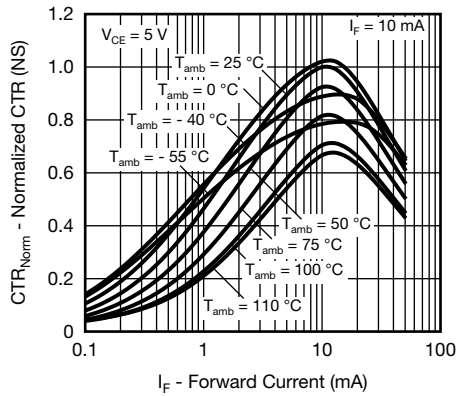

Fig. 10 - Normalized CTR (NS) vs. Forward Current

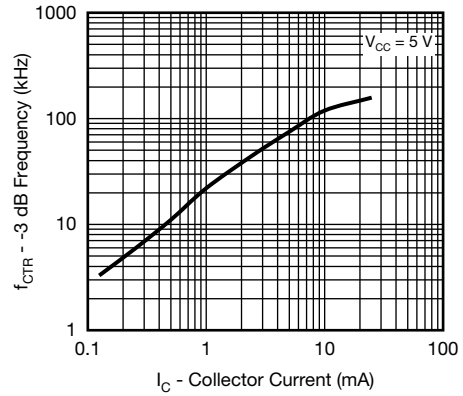

Fig. 13 - CTR -3 dB Frequency vs. Collector Current

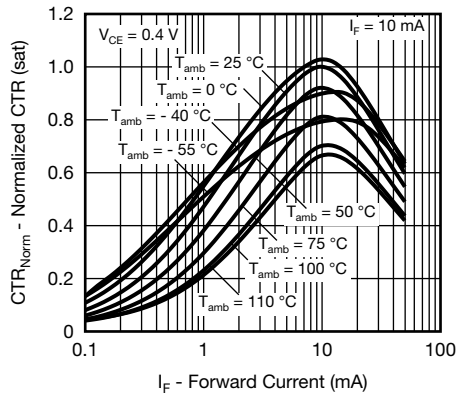

Fig. 11 - Normalized CTR (sat) vs. Forward Current

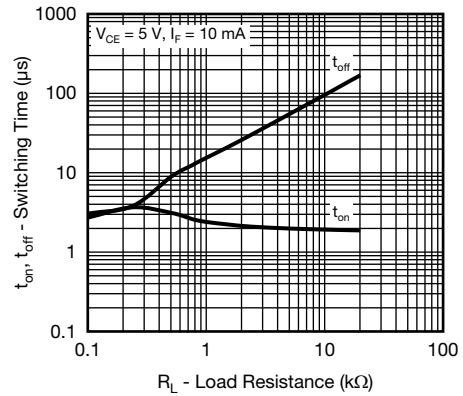

Fig. 14 - Switching Time vs. Load Resistance

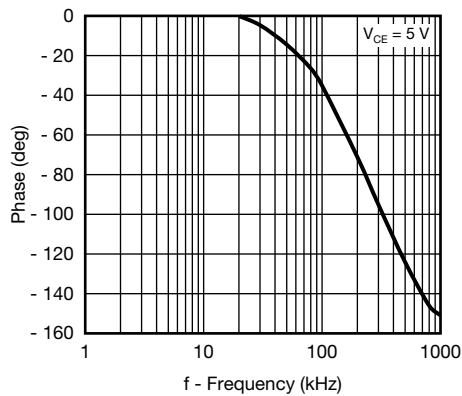
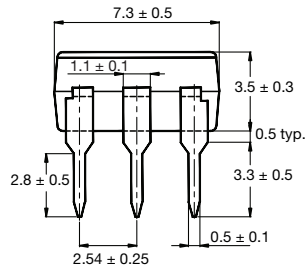
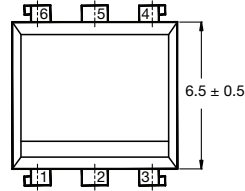

Fig. 12 - CTR Frequency vs. Phase Angle

PACKAGE DIMENSIONS in millimeters



22530

Option 6

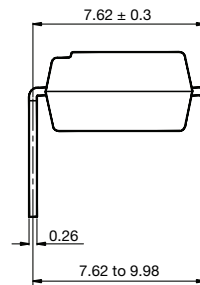

Option 7

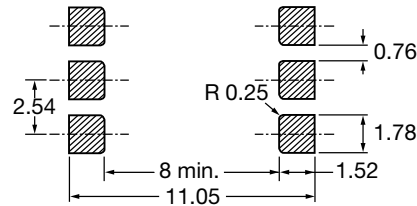
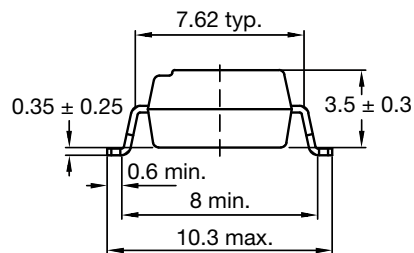
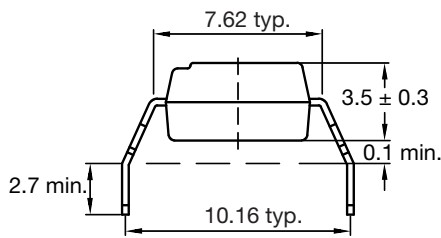

20802-35

PACKAGE MARKING (Example of CNY117-3X017T)



Notes

- VDE logo is only marked on option 1 parts. Option information is not marked on the part.
- Tape and reel suffix (T) is not part of the package marking.

TUBE AND TAPE INFORMATION

| DEVICES PER TUBE | | | |
|------------------|------------|-----------|-----------|
| TYPE | UNITS/TUBE | TUBES/BOX | UNITS/BOX |
| DIP-6 | 50 | 40 | 2000 |

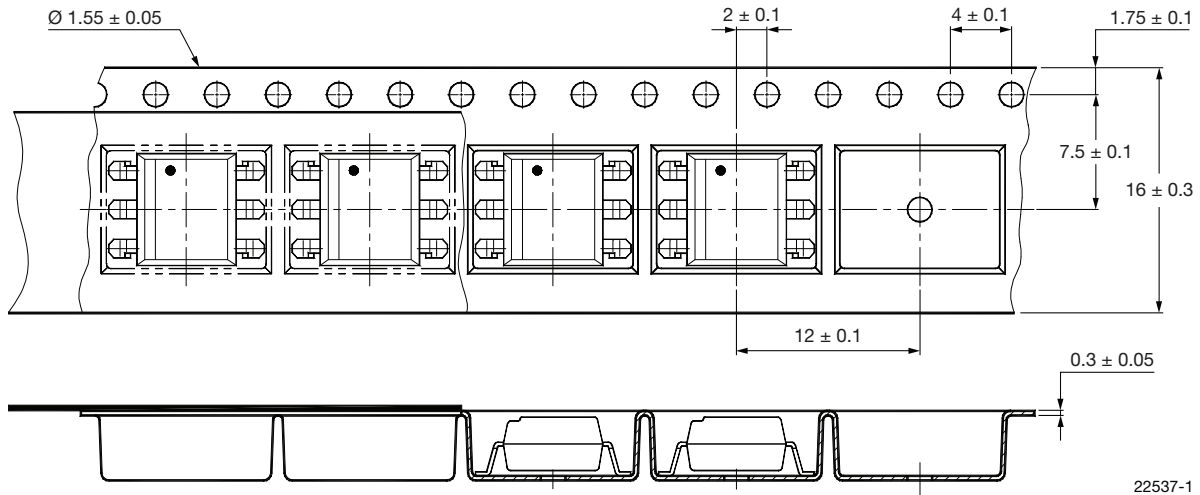

Fig. 15 - Tape and Reel Drawing, 1000 Units per Reel



Disclaimer

ALL PRODUCT, PRODUCT SPECIFICATIONS AND DATA ARE SUBJECT TO CHANGE WITHOUT NOTICE TO IMPROVE RELIABILITY, FUNCTION OR DESIGN OR OTHERWISE.

Vishay Intertechnology, Inc., its affiliates, agents, and employees, and all persons acting on its or their behalf (collectively, "Vishay"), disclaim any and all liability for any errors, inaccuracies or incompleteness contained in any datasheet or in any other disclosure relating to any product.

Vishay makes no warranty, representation or guarantee regarding the suitability of the products for any particular purpose or the continuing production of any product. To the maximum extent permitted by applicable law, Vishay disclaims (i) any and all liability arising out of the application or use of any product, (ii) any and all liability, including without limitation special, consequential or incidental damages, and (iii) any and all implied warranties, including warranties of fitness for particular purpose, non-infringement and merchantability.

Statements regarding the suitability of products for certain types of applications are based on Vishay's knowledge of typical requirements that are often placed on Vishay products in generic applications. Such statements are not binding statements about the suitability of products for a particular application. It is the customer's responsibility to validate that a particular product with the properties described in the product specification is suitable for use in a particular application. Parameters provided in datasheets and/or specifications may vary in different applications and performance may vary over time. All operating parameters, including typical parameters, must be validated for each customer application by the customer's technical experts. Product specifications do not expand or otherwise modify Vishay's terms and conditions of purchase, including but not limited to the warranty expressed therein.

Except as expressly indicated in writing, Vishay products are not designed for use in medical, life-saving, or life-sustaining applications or for any other application in which the failure of the Vishay product could result in personal injury or death. Customers using or selling Vishay products not expressly indicated for use in such applications do so at their own risk. Please contact authorized Vishay personnel to obtain written terms and conditions regarding products designed for such applications.

No license, express or implied, by estoppel or otherwise, to any intellectual property rights is granted by this document or by any conduct of Vishay. Product names and markings noted herein may be trademarks of their respective owners.

Material Category Policy

Vishay Intertechnology, Inc. hereby certifies that all its products that are identified as RoHS-Compliant fulfill the definitions and restrictions defined under Directive 2011/65/EU of The European Parliament and of the Council of June 8, 2011 on the restriction of the use of certain hazardous substances in electrical and electronic equipment (EEE) - recast, unless otherwise specified as non-compliant.

Please note that some Vishay documentation may still make reference to RoHS Directive 2002/95/EC. We confirm that all the products identified as being compliant to Directive 2002/95/EC conform to Directive 2011/65/EU.

Vishay Intertechnology, Inc. hereby certifies that all its products that are identified as Halogen-Free follow Halogen-Free requirements as per JEDEC JS709A standards. Please note that some Vishay documentation may still make reference to the IEC 61249-2-21 definition. We confirm that all the products identified as being compliant to IEC 61249-2-21 conform to JEDEC JS709A standards.

Данный компонент на территории Российской Федерации

Вы можете приобрести в компании MosChip.

Для оперативного оформления запроса Вам необходимо перейти по данной ссылке:

<http://moschip.ru/get-element>

Вы можете разместить у нас заказ для любого Вашего проекта, будь то серийное производство или разработка единичного прибора.

В нашем ассортименте представлены ведущие мировые производители активных и пассивных электронных компонентов.

Нашей специализацией является поставка электронной компонентной базы двойного назначения, продукции таких производителей как XILINX, Intel (ex.ALTERA), Vicor, Microchip, Texas Instruments, Analog Devices, Mini-Circuits, Amphenol, Glenair.

Сотрудничество с глобальными дистрибьюторами электронных компонентов, предоставляет возможность заказывать и получать с международных складов практически любой перечень компонентов в оптимальные для Вас сроки.

На всех этапах разработки и производства наши партнеры могут получить квалифицированную поддержку опытных инженеров.

Система менеджмента качества компании отвечает требованиям в соответствии с ГОСТ Р ИСО 9001, ГОСТ РВ 0015-002 и ЭС РД 009

Офис по работе с юридическими лицами:

105318, г.Москва, ул.Щербаковская д.3, офис 1107, 1118, ДЦ «Щербаковский»

Телефон: +7 495 668-12-70 (многоканальный)

Факс: +7 495 668-12-70 (доб.304)

E-mail: info@moschip.ru

Skype отдела продаж:

moschip.ru

moschip.ru_4

moschip.ru_6

moschip.ru_9