



# Phase Control Thyristors (Hockey PUK Version), 990 A



TO-200AC (B-PUK)

### FEATURES

- Center amplifying gate
- Metal case with ceramic insulator
- International standard case TO-200AC (B-PUK)
- Designed and qualified for industrial level
- Material categorization: For definitions of compliance please see [www.vishay.com/doc?99912](http://www.vishay.com/doc?99912)



RoHS  
COMPLIANT

### TYPICAL APPLICATIONS

- DC motor controls
- Controlled DC power supplies
- AC controllers

| PRODUCT SUMMARY   |   |
|-------------------|---|
| Package           | TO-200AC (B-PUK)                              |
| Diode variation   | Single SCR                                    |
| $I_{T(AV)}$       | 990 A   |
| $V_{DRM}/V_{RRM}$ | 800 V, 1200 V, 1400 V, 1600 V, 1800 V, 2000 V |
| $V_{TM}$          | 1.62 V  |
| $I_{GT}$          | 100 mA  |
| $T_J$             | -40 °C to 125 °C                              |

| MAJOR RATINGS AND CHARACTERISTICS |                 |             |                   |
|-----------------------------------|-----------------|-------------|-------------------|
| PARAMETER                         | TEST CONDITIONS | VALUES      | UNITS             |
| $I_{T(AV)}$                       |                 | 990         | A                 |
|                                   | $T_{hs}$        | 55          | °C                |
| $I_{T(RMS)}$                      |                 | 2000        | A                 |
|                                   | $T_{hs}$        | 25          | °C                |
| $I_{TSM}$                         | 50 Hz           | 17 800      | A                 |
|                                   | 60 Hz           | 18 700      |                   |
| $I^2t$                            | 50 Hz           | 1591        | kA <sup>2</sup> s |
|                                   | 60 Hz           | 1452        |                   |
| $V_{DRM}/V_{RRM}$                 |                 | 800 to 2000 | V                 |
| $t_q$                             | Typical         | 150         | µs                |
| $T_J$                             |                 | -40 to 125  | °C                |

| VOLTAGE RATINGS |              |  |  |  |
|-----------------|--------------|--|--|--|
| TYPE NUMBER     | VOLTAGE CODE | $V_{DRM}/V_{RRM}$ , MAXIMUM REPETITIVE PEAK AND OFF-STATE VOLTAGE<br>V | $V_{RSM}$ , MAXIMUM NON-REPETITIVE PEAK VOLTAGE<br>V | $I_{DRM}/I_{RRM}$ MAXIMUM AT $T_J = T_J$ MAXIMUM<br>mA |
| VS-ST730CL      | 08           | 800  | 900  | 80   |
|                 | 12           | 1200   | 1300   |  |
|                 | 14           | 1400   | 1500   |  |
|                 | 16           | 1600   | 1700   |  |
|                 | 18           | 1800   | 1900   |  |
|                 | 20           | 2000   | 2100   |  |



| <b>ABSOLUTE MAXIMUM RATINGS</b>                          |                |  |                           |           |                    |
|--|----------------|--|---------------------------|-----------|--------------------|
| PARAMETER  | SYMBOL         | TEST CONDITIONS  |                           | VALUES    | UNITS              |
| Maximum average on-state current at heatsink temperature | $I_{T(AV)}$    | 180° conduction, half sine wave double side (single side) cooled       |                           | 990 (375) | A                  |
|  |                |  |                           | 55 (85)   | °C                 |
| Maximum RMS on-state current                             | $I_{T(RMS)}$   | DC at 25 °C heatsink temperature double side cooled                    |                           | 2000      | A                  |
| Maximum peak, one-cycle non-repetitive surge current     | $I_{TSM}$      | t = 10 ms  | No voltage reapplied      | 17 800    |                    |
|  |                | t = 8.3 ms   |                           | 18 700    |                    |
|  |                | t = 10 ms  | 100 % $V_{RRM}$ reapplied | 15 000    |                    |
|  |                | t = 8.3 ms   |                           | 15 700    |                    |
| Maximum $I^2t$ for fusing                                | $I^2t$         | t = 10 ms  | No voltage reapplied      | 1591      | kA <sup>2</sup> s  |
|  |                | t = 8.3 ms   |                           | 1452      |                    |
|  |                | t = 10 ms  | 100 % $V_{RRM}$ reapplied | 1125      |                    |
|  |                | t = 8.3 ms   |                           | 1027      |                    |
| Maximum $I^2\sqrt{t}$ for fusing                         | $I^2\sqrt{t}$  | t = 0.1 to 10 ms, no voltage reapplied                                 |                           | 15 910    | kA <sup>2</sup> √s |
| Low level value of threshold voltage                     | $V_{T(TO)1}$   | (16.7 % × π × $I_{T(AV)}$ < I < π × $I_{T(AV)}$ ), $T_J = T_J$ maximum |                           | 0.98      | V                  |
| High level value of threshold voltage                    | $V_{T(TO)2}$   | (I > π × $I_{T(AV)}$ ), $T_J = T_J$ maximum                            |                           | 1.12      |                    |
| Low level value of on-state slope resistance             | $r_{\theta 1}$ | (16.7 % × π × $I_{T(AV)}$ < I < π × $I_{T(AV)}$ ), $T_J = T_J$ maximum |                           | 0.32      | mΩ                 |
| High level value of on-state slope resistance            | $r_{\theta 2}$ | (I > π × $I_{T(AV)}$ ), $T_J = T_J$ maximum                            |                           | 0.27      |                    |
| Maximum on-state voltage                                 | $V_{TM}$       | $I_{pk} = 2000$ A, $T_J = T_J$ maximum, $t_p = 10$ ms sine pulse       |                           | 1.62      | V                  |
| Maximum holding current                                  | $I_H$          | $T_J = 25$ °C, anode supply 12 V resistive load                        |                           | 600       | mA                 |
| Typical latching current                                 | $I_L$          |  |                           | 1000      |                    |

| <b>SWITCHING</b>   |        |  |  |        |       |
|--|--------|--|--|--------|-------|
| PARAMETER  | SYMBOL | TEST CONDITIONS  |  | VALUES | UNITS |
| Maximum non-repetitive rate of rise of turned-on current | di/dt  | Gate drive 20 V, 20 Ω, $t_r \leq 1$ μs<br>$T_J = T_J$ maximum, anode voltage ≤ 80 % $V_{DRM}$                            |  | 1000   | A/μs  |
| Typical delay time                                       | $t_d$  | Gate current 1 A, di <sub>g</sub> /dt = 1 A/μs<br>$V_d = 0.67$ % $V_{DRM}$ , $T_J = 25$ °C                               |  | 1.0    | μs    |
| Typical turn-off time                                    | $t_q$  | $I_{TM} = 750$ A, $T_J = T_J$ maximum, di/dt = 60 A/μs,<br>$V_R = 50$ V, dV/dt = 20 V/μs, gate 0 V 100 Ω, $t_p = 500$ μs |  | 150    |       |

| <b>BLOCKING</b>                                    |                          |  |  |        |       |
|--|--------------------------|--|--|--------|-------|
| PARAMETER  | SYMBOL                   | TEST CONDITIONS                                      |  | VALUES | UNITS |
| Maximum critical rate of rise of off-state voltage | dV/dt                    | $T_J = T_J$ maximum linear to 80 % rated $V_{DRM}$   |  | 500    | V/μs  |
| Maximum peak reverse and off-state leakage current | $I_{RRM}$ ,<br>$I_{DRM}$ | $T_J = T_J$ maximum, rated $V_{DRM}/V_{RRM}$ applied |  | 80     | mA    |



| TRIGGERING                          |             |  |  |      |       |    |
|-------------------------------------|-------------|--|--|------|-------|----|
| PARAMETER                           | SYMBOL      | TEST CONDITIONS                              | VALUES   |      | UNITS |    |
|                                     |             |  | Typ.   | Max. |       |    |
| Maximum peak gate power             | $P_{GM}$    | $T_J = T_J$ maximum, $t_p \leq 5$ ms         | 10.0   |      | W     |    |
| Maximum average gate power          | $P_{G(AV)}$ | $T_J = T_J$ maximum, $f = 50$ Hz, $d\% = 50$ | 2.0  |      |       |    |
| Maximum peak positive gate current  | $I_{GM}$    | $T_J = T_J$ maximum, $t_p \leq 5$ ms         | 3.0  |      | A     |    |
| Maximum peak positive gate voltage  | $+V_{GM}$   | $T_J = T_J$ maximum, $t_p \leq 5$ ms         | 20   |      | V     |    |
| Maximum peak negative gate voltage  | $-V_{GM}$   |  | 5.0  |      |       |    |
| DC gate current required to trigger | $I_{GT}$    | $T_J = -40$ °C                               | Maximum required gate trigger/ current/voltage are the lowest value which will trigger all units 12 V anode to cathode applied | 200  | -     | mA |
|                                     |             | $T_J = 25$ °C                                |  | 100  | 200   |    |
|                                     |             | $T_J = 125$ °C                               |  | 50   | -     |    |
| DC gate voltage required to trigger | $V_{GT}$    | $T_J = -40$ °C                               |  | 2.5  | -     | V  |
|                                     |             | $T_J = 25$ °C                                |  | 1.8  | 3.0   |    |
|                                     |             | $T_J = 125$ °C                               |  | 1.1  | -     |    |
| DC gate current not to trigger      | $I_{GD}$    | $T_J = T_J$ maximum                          | 10   |      | mA    |    |
| DC gate voltage not to trigger      | $V_{GD}$    |  | 0.25   |      | V     |    |

| THERMAL AND MECHANICAL SPECIFICATIONS            |              |   |                  |           |
|--|--------------|---|------------------|-----------|
| PARAMETER  | SYMBOL       | TEST CONDITIONS                               | VALUES           | UNITS     |
| Maximum operating junction temperature range     | $T_J$        |   | -40 to 125       | °C        |
| Maximum storage temperature range                | $T_{Stg}$    |   | -40 to 150       |           |
| Maximum thermal resistance, junction to heatsink | $R_{thJ-hs}$ | DC operation single side cooled               | 0.073            | K/W       |
|  |              | DC operation double side cooled               | 0.031            |           |
| Maximum thermal resistance, case to heatsink     | $R_{thC-hs}$ | DC operation single side cooled               | 0.011            |           |
|  |              | DC operation double side cooled               | 0.006            |           |
| Mounting force, $\pm 10$ %                       |              |   | 14 700<br>(1500) | N<br>(kg) |
| Approximate weight                               |              |   | 255              | g         |
| Case style                                       |              | See dimensions - link at the end of datasheet | TO-200AC (B-PUK) |           |

| $\Delta R_{thJ-hs}$ CONDUCTION |                       |             |                        |             |                     |       |
|--------------------------------|-----------------------|-------------|------------------------|-------------|---------------------|-------|
| CONDUCTION ANGLE               | SINUSOIDAL CONDUCTION |             | RECTANGULAR CONDUCTION |             | TEST CONDITIONS     | UNITS |
|                                | SINGLE SIDE           | DOUBLE SIDE | SINGLE SIDE            | DOUBLE SIDE |                     |       |
| 180°                           | 0.009                 | 0.009       | 0.006                  | 0.006       | $T_J = T_J$ maximum | K/W   |
| 120°                           | 0.011                 | 0.011       | 0.010                  | 0.011       |                     |       |
| 90°                            | 0.014                 | 0.014       | 0.015                  | 0.015       |                     |       |
| 60°                            | 0.020                 | 0.020       | 0.021                  | 0.021       |                     |       |
| 30°                            | 0.036                 | 0.036       | 0.036                  | 0.036       |                     |       |

**Note**

- The table above shows the increment of thermal resistance  $R_{thJ-hs}$  when devices operate at different conduction angles than DC

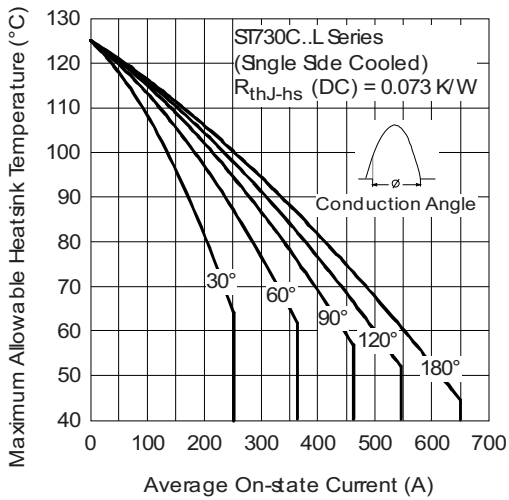

Fig. 1 - Current Ratings Characteristics

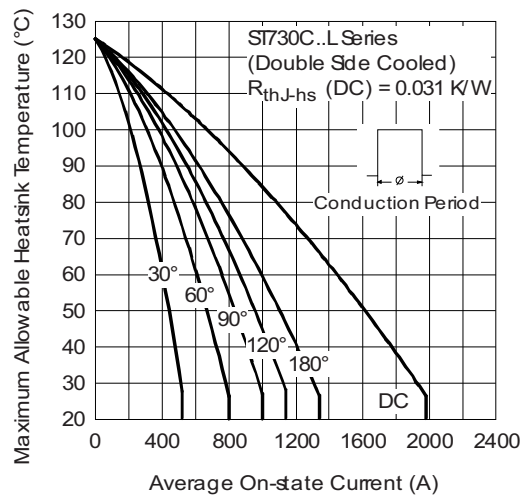

Fig. 4 - Current Ratings Characteristics

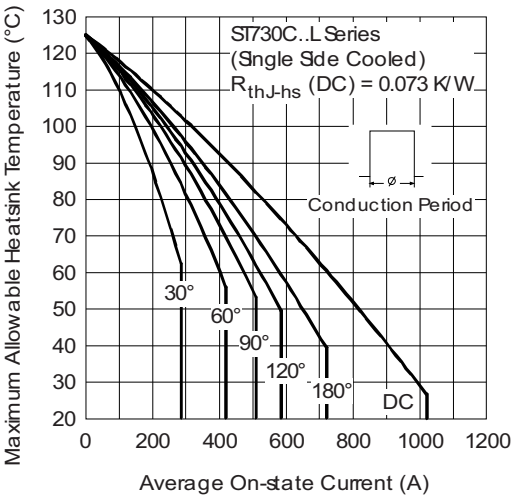

Fig. 2 - Current Ratings Characteristics

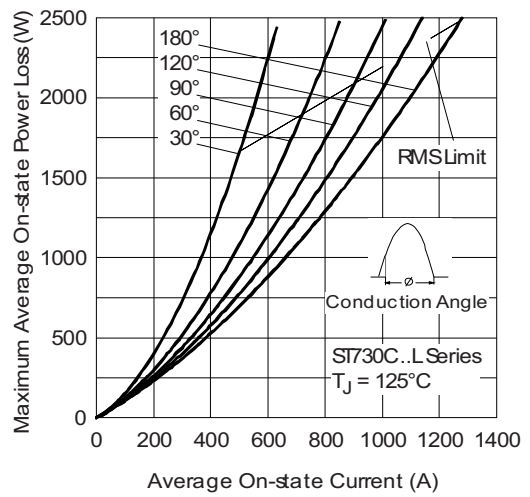

Fig. 5 - On-State Power Loss Characteristics

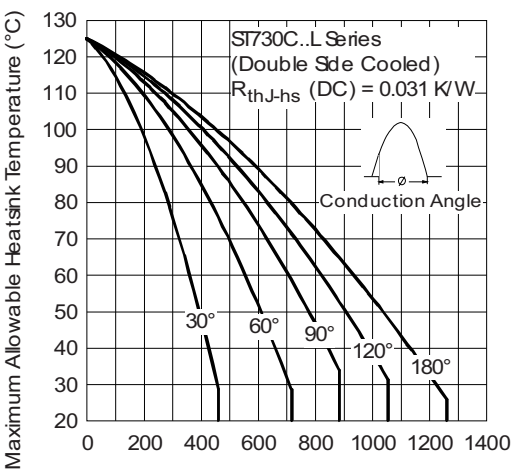

Fig. 3 - Current Ratings Characteristics

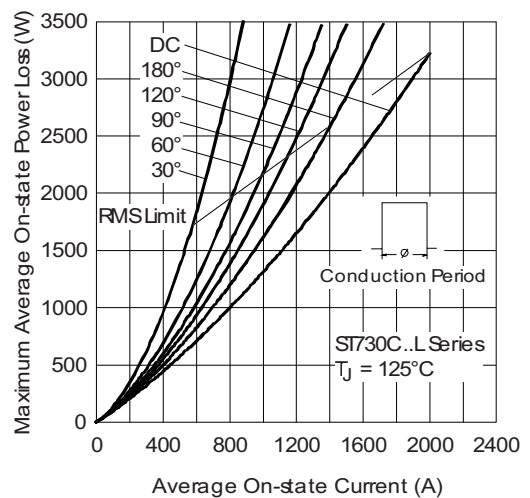

Fig. 6 - On-State Power Loss Characteristics

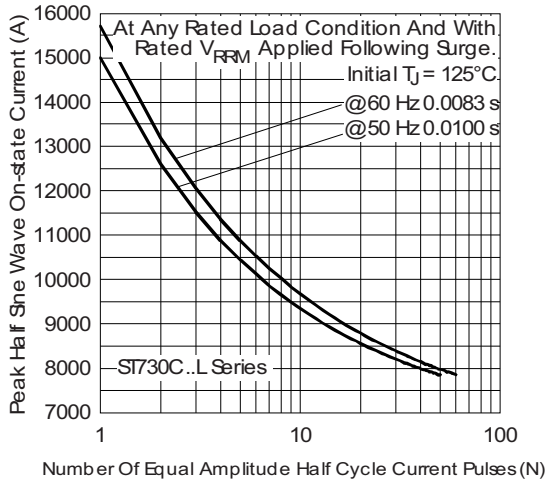

Fig. 7 - Maximum Non-Repetitive Surge Current Single and Double Side Cooled

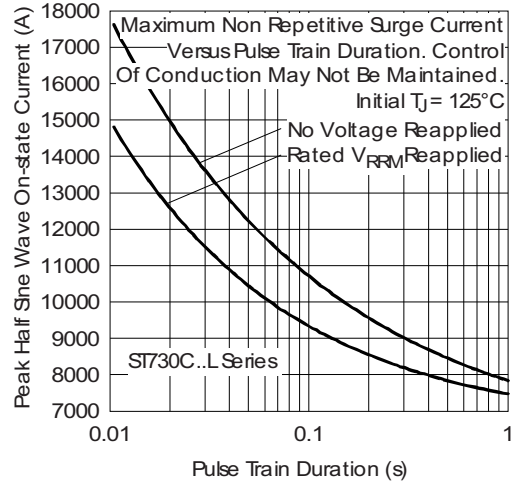

Fig. 8 - Maximum Non-Repetitive Surge Current Single and Double Side Cooled

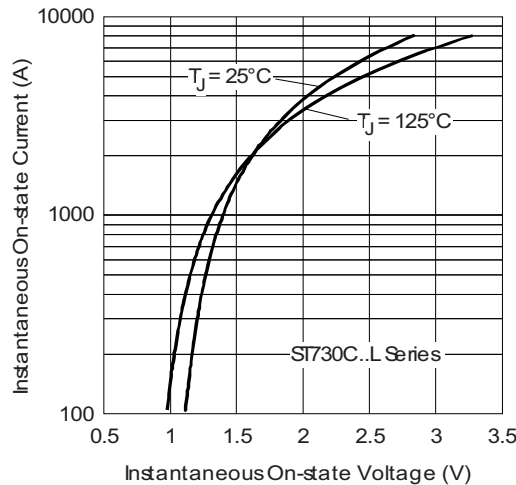

Fig. 9 - On-State Voltage Drop Characteristics

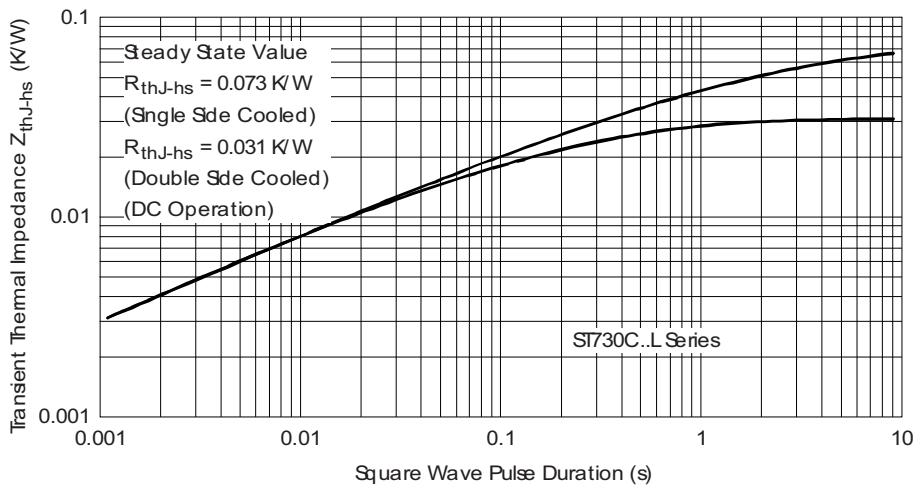

Fig. 10 - Thermal Impedance  $Z_{thJ-hs}$  Characteristics

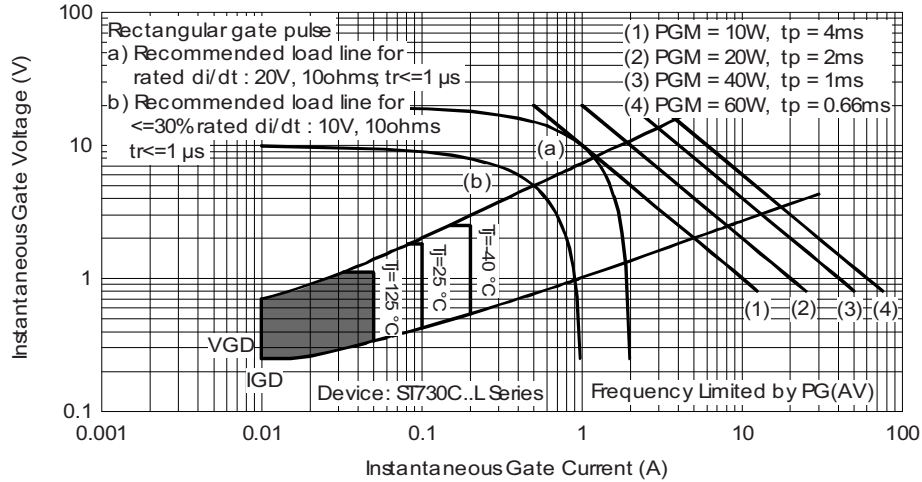

Fig. 11 - Gate Characteristics

**ORDERING INFORMATION TABLE**

|             |            |           |           |          |          |           |          |          |          |
|-------------|------------|-----------|-----------|----------|----------|-----------|----------|----------|----------|
| Device code | <b>VS-</b> | <b>ST</b> | <b>73</b> | <b>0</b> | <b>C</b> | <b>20</b> | <b>L</b> | <b>1</b> | <b>-</b> |
|             | (1)        | (2)       | (3)       | (4)      | (5)      | (6)       | (7)      | (8)      | (9)      |

- 1** - Vishay Semiconductors product
- 2** - Thyristor
- 3** - Essential part number
- 4** - 0 = Converter grade
- 5** - C = Ceramic PUK
- 6** - Voltage code x 100 = V<sub>RRM</sub> (see Voltage Ratings table)
- 7** - L = PUK case TO-200AC (B-PUK)
- 8** - 0 = Eyelet terminals (gate and auxiliary cathode unsoldered leads)  
 1 = Fast-on terminals (gate and auxiliary cathode unsoldered leads)  
 2 = Eyelet terminals (gate and auxiliary cathode soldered leads)  
 3 = Fast-on terminals (gate and auxiliary cathode soldered leads)
- 9** - Critical dV/dt: • None = 500 V/μs (standard selection)  
 • L = 1000 V/μs (special selection)

| LINKS TO RELATED DOCUMENTS |  |
|----------------------------|--|
| Dimensions                 | <a href="http://www.vishay.com/doc?95076">www.vishay.com/doc?95076</a> |

## TO-200AC (B-PUK)

**DIMENSIONS** in millimeters (inches)

Creepage distance: 36.33 (1.430) minimum  
 Strike distance: 17.43 (0.686) minimum

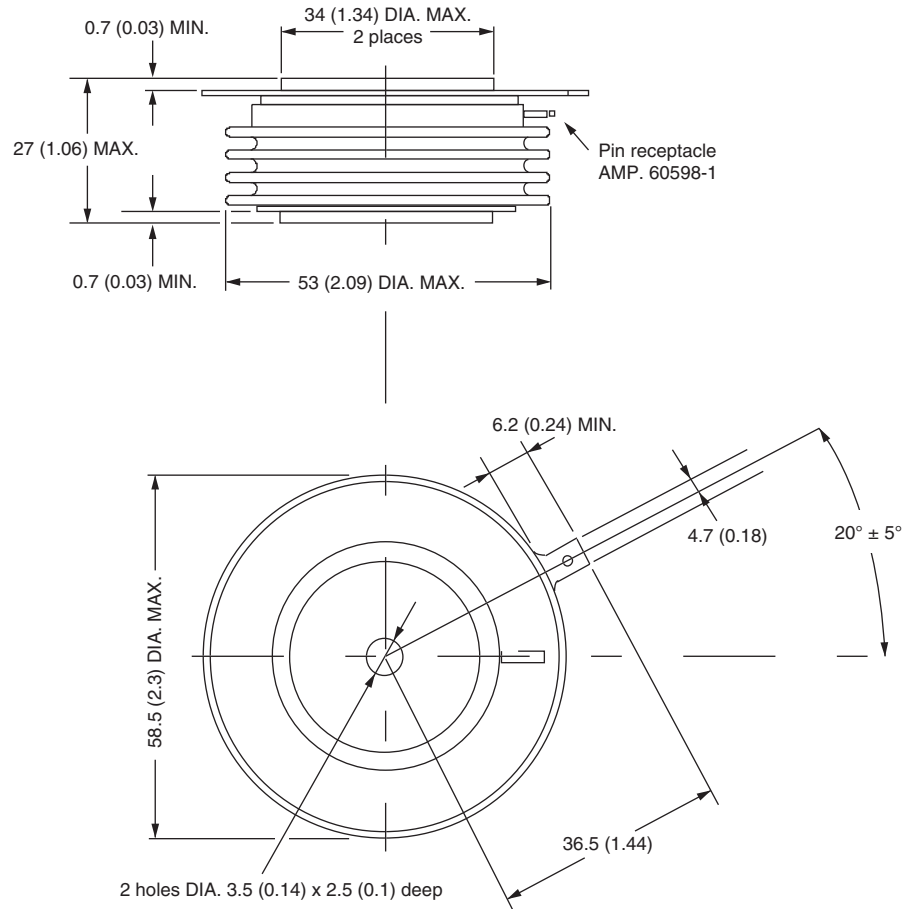

Quote between upper and lower pole pieces has to be considered after application of mounting force (see thermal and mechanical specification)



## Disclaimer

ALL PRODUCT, PRODUCT SPECIFICATIONS AND DATA ARE SUBJECT TO CHANGE WITHOUT NOTICE TO IMPROVE RELIABILITY, FUNCTION OR DESIGN OR OTHERWISE.

Vishay Intertechnology, Inc., its affiliates, agents, and employees, and all persons acting on its or their behalf (collectively, "Vishay"), disclaim any and all liability for any errors, inaccuracies or incompleteness contained in any datasheet or in any other disclosure relating to any product.

Vishay makes no warranty, representation or guarantee regarding the suitability of the products for any particular purpose or the continuing production of any product. To the maximum extent permitted by applicable law, Vishay disclaims (i) any and all liability arising out of the application or use of any product, (ii) any and all liability, including without limitation special, consequential or incidental damages, and (iii) any and all implied warranties, including warranties of fitness for particular purpose, non-infringement and merchantability.

Statements regarding the suitability of products for certain types of applications are based on Vishay's knowledge of typical requirements that are often placed on Vishay products in generic applications. Such statements are not binding statements about the suitability of products for a particular application. It is the customer's responsibility to validate that a particular product with the properties described in the product specification is suitable for use in a particular application. Parameters provided in datasheets and/or specifications may vary in different applications and performance may vary over time. All operating parameters, including typical parameters, must be validated for each customer application by the customer's technical experts. Product specifications do not expand or otherwise modify Vishay's terms and conditions of purchase, including but not limited to the warranty expressed therein.

Except as expressly indicated in writing, Vishay products are not designed for use in medical, life-saving, or life-sustaining applications or for any other application in which the failure of the Vishay product could result in personal injury or death. Customers using or selling Vishay products not expressly indicated for use in such applications do so at their own risk. Please contact authorized Vishay personnel to obtain written terms and conditions regarding products designed for such applications.

No license, express or implied, by estoppel or otherwise, to any intellectual property rights is granted by this document or by any conduct of Vishay. Product names and markings noted herein may be trademarks of their respective owners.

## Material Category Policy

**Vishay Intertechnology, Inc. hereby certifies that all its products that are identified as RoHS-Compliant fulfill the definitions and restrictions defined under Directive 2011/65/EU of The European Parliament and of the Council of June 8, 2011 on the restriction of the use of certain hazardous substances in electrical and electronic equipment (EEE) - recast, unless otherwise specified as non-compliant.**

**Please note that some Vishay documentation may still make reference to RoHS Directive 2002/95/EC. We confirm that all the products identified as being compliant to Directive 2002/95/EC conform to Directive 2011/65/EU.**

**Vishay Intertechnology, Inc. hereby certifies that all its products that are identified as Halogen-Free follow Halogen-Free requirements as per JEDEC JS709A standards. Please note that some Vishay documentation may still make reference to the IEC 61249-2-21 definition. We confirm that all the products identified as being compliant to IEC 61249-2-21 conform to JEDEC JS709A standards.**



## Данный компонент на территории Российской Федерации

### Вы можете приобрести в компании MosChip.

Для оперативного оформления запроса Вам необходимо перейти по данной ссылке:

<http://moschip.ru/get-element>

Вы можете разместить у нас заказ для любого Вашего проекта, будь то серийное производство или разработка единичного прибора.

В нашем ассортименте представлены ведущие мировые производители активных и пассивных электронных компонентов.

Нашей специализацией является поставка электронной компонентной базы двойного назначения, продукции таких производителей как XILINX, Intel (ex.ALTERA), Vicor, Microchip, Texas Instruments, Analog Devices, Mini-Circuits, Amphenol, Glenair.

Сотрудничество с глобальными дистрибьюторами электронных компонентов, предоставляет возможность заказывать и получать с международных складов практически любой перечень компонентов в оптимальные для Вас сроки.

На всех этапах разработки и производства наши партнеры могут получить квалифицированную поддержку опытных инженеров.

Система менеджмента качества компании отвечает требованиям в соответствии с ГОСТ Р ИСО 9001, ГОСТ РВ 0015-002 и ЭС РД 009

### Офис по работе с юридическими лицами:

105318, г.Москва, ул.Щербаковская д.3, офис 1107, 1118, ДЦ «Щербаковский»

Телефон: +7 495 668-12-70 (многоканальный)

Факс: +7 495 668-12-70 (доб.304)

E-mail: [info@moschip.ru](mailto:info@moschip.ru)

Skype отдела продаж:

moschip.ru

moschip.ru\_4

moschip.ru\_6

moschip.ru\_9