

HMIC™ PIN Diode SPDT 50 Watt Switch for 0.05 - 6.0 GHz Higher Power Applications

Rev. V8

Features

- Exceptional Broadband Performance, 0.05 - 6.0 GHz
- Low Loss: $T_x = 0.33 \text{ dB @ } 2010 \text{ MHz, } 5\text{V} / 20\text{mA}$
- $T_x = 0.38 \text{ dB @ } 3.5 \text{ GHz, } 5\text{V} / 20\text{mA}$
- High Isolation: $R_x = 44\text{dB @ } 2010 \text{ MHz, } 20\text{mA} / 5\text{V}$
- $R_x = 36\text{dB @ } 3.5 \text{ GHz, } 20\text{mA} / 5\text{V}$
- High T_x RF Input Power = 50 W C.W. @ 2010MHz
- High Tx RF Input Peak Power > 1000 W
- Suitable for Very High Power TD-SCDMA & WiMAX Applications
- Surface Mount 4mm PQFN Package, RoHS* Compliant

Description and Applications

The MASW-000834-13560T is a SPDT Broadband, high linearity, common anode, PIN diode T/R switch for 0.05 - 6.0 GHz applications, including WiMAX & WiFi. The device is provided in industry standard 4mm PQFN plastic packaging. This device incorporates a PIN diode die fabricated with M/A-COM Technology Solutions patented Silicon-Glass HMIC™ process. This chip features two silicon pedestals embedded in a low loss, low dispersion glass. The diodes are formed on the top of each pedestal. The topside is fully encapsulated with silicon nitride and has an additional polymer passivation layer. These polymer protective coatings prevent damage and contamination during handling and assembly.

This compact 4mm PQFN package, SPDT switch offers wideband 0.05 - 6.0 GHz performance with excellent isolation to loss ratio for both T_x and R_x states. The PIN diode provides 50 W typical C.W. power handling and 65 dBm IIP3 at 2010 MHz for maximum switch performance.

Absolute Maximum Ratings^{1,2}

@ $T_A = +25 \text{ °C}$ (unless otherwise specified)

Parameter	Absolute Maximum
Forward Current	100 mA
Reverse Voltage (RF & D.C.)	-200 V
Operating Temperature	-40 °C to +85 °C
Storage Temperature	-55 °C to +150 °C
Junction Temperature	+175 °C
T_x Incident C.W. Power	50W (47 dBm) ³ @ 2010MHz
T_x Peak Incident Power	>300 W, 5us, 1% duty

1. Exceeding these limits may cause permanent damage.
2. M/A-COM Technology Solutions does not recommend sustained operation near these survivability limits.
3. Baseplate Temperature must be controlled to a constant +25°C. See page 7 for derating curve.

* Restrictions on Hazardous Substances, European Union Directive 2002/95/EC.

Functional Diagram (TOP VIEW)

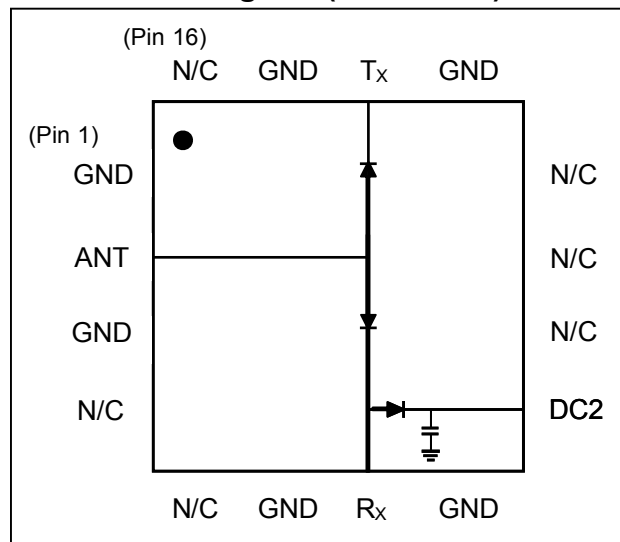

Pin Configuration:

(Center Metal Area is RF, D.C., and Thermal Ground)

Pin	Function	Pin	Function
1	GND	9	DC2
2	ANT	10	N/C
3	GND	11	N/C
4	N/C	12	N/C
5	N/C	13	GND
6	GND	14	TX
7	RX	15	GND
8	GND	16	N/C

Ordering Information

Part Number	Package
MASW-000834-13560T	Tape and Reel
MASW-000834-001SMB	Sample Board
MADR-008851-0001TB	Sample Board with recommended external Driver & MASW-000834-13560T Switch

Static Sensitivity

These devices are rated Class 1B Human Body. Proper ESD control techniques should be used when handling these devices.

ADVANCED: Data Sheets contain information regarding a product M/A-COM Technology Solutions is considering for development. Performance is based on target specifications, simulated results, and/or prototype measurements. Commitment to develop is not guaranteed.

PRELIMINARY: Data Sheets contain information regarding a product M/A-COM Technology Solutions has under development. Performance is based on engineering tests. Specifications are typical. Mechanical outline has been fixed. Engineering samples and/or test data may be available. Commitment to produce in volume is not guaranteed.

• **North America** Tel: 800.366.2266 • **Europe** Tel: +353.21.244.6400
 • **India** Tel: +91.80.43537383 • **China** Tel: +86.21.2407.1588

Visit www.macomtech.com for additional data sheets and product information.

M/A-COM Technology Solutions Inc. and its affiliates reserve the right to make changes to the product(s) or information contained herein without notice.

Electrical Specifications at +25°C, Characteristic Impedance, 20mA / 5V, $Z_0 = 50 \Omega$

Parameter	Symbol	20mA / 5V Conditions	Units	Min.	Typ.	Max.
F = 900 MHz						
Insertion Loss, R_X	R_X IL	See Bias Table 1, pg. 10, Pinc= 0 dBm	dB	—	0.34	0.56
Insertion Loss, T_X	T_X IL	See Bias Table 1, pg. 10, Pinc= 0 dBm	dB	—	0.26	0.445
Isolation, ANT To R_X	R_X ISO	See Bias Table 1, pg. 10, Pinc= 0 dBm	dB	45.8	52.1	—
Isolation, ANT To T_X	T_X ISO	See Bias Table 1, pg. 10, Pinc= 0 dBm	dB	21.7	27.1	—
F = 1800 MHz						
Insertion Loss, R_X	R_X IL	See Bias Table 1, pg. 10, Pinc= 0 dBm	dB	—	0.40	0.72
Insertion Loss, T_X	T_X IL	See Bias Table 1, pg. 10, Pinc= 0 dBm	dB	—	0.32	0.49
Isolation, ANT To R_X	R_X ISO	See Bias Table 1, pg. 10, Pinc= 0 dBm	dB	43.7	48.9	—
Isolation, ANT To T_X	T_X ISO	See Bias Table 1, pg. 10, Pinc= 0 dBm	dB	18.4	21.4	—
F = 2010 MHz						
Insertion Loss, R_X	R_X IL	See Bias Table 1, pg. 10, Pinc= 0 dBm	dB	—	0.42	0.75
Insertion Loss, T_X	T_X IL	See Bias Table 1, pg. 10, Pinc= 0 dBm	dB	—	0.33	0.5
Isolation, ANT To R_X	R_X ISO	See Bias Table 1, pg. 10, Pinc= 0 dBm	dB	43.2	44.6	—
Isolation, ANT To T_X	T_X ISO	See Bias Table 1, pg. 10, Pinc= 0 dBm	dB	17.7	19.9	—
Input Return Loss, T_X	T_X RL	See Bias Table 1, pg. 10, Pinc= 0 dBm	dB	—	32.1	—
Input Return Loss, R_X	R_X RL	See Bias Table 1, pg. 10, Pinc= 0 dBm	dB	—	24.2	—

HMIC™ PIN Diode SPDT 50 Watt Switch for 0.05 - 6.0 GHz Higher Power Applications

Rev. V8

Electrical Specifications at +25°C, Characteristic Impedance, 20mA / 5V, $Z_0 = 50 \Omega$

Parameter	Symbol	20mA / 5V Conditions	Units	Min.	Typ.	Max.
F = 2.3-2.7 GHz						
Insertion Loss, R_X	R_X IL	See Bias Table 1, pg. 10, Pinc= 0 dBm	dB	—	0.46	0.84
Insertion Loss, T_X	T_X IL	See Bias Table 1, pg. 10, Pinc= 0 dBm	dB	—	0.35	0.525
Isolation, ANT To R_X	R_X ISO	See Bias Table 1, pg. 10, Pinc= 0 dBm	dB	40.2	41.2	—
Isolation, ANT To T_X	T_X ISO	See Bias Table 1, pg. 10, Pinc= 0 dBm	dB	16.2	18.6	—
Input Return Loss, T_X	T_X RL	See Bias Table 1, pg. 10, Pinc= 0 dBm	dB	—	30.5	—
Input Return Loss, R_X	R_X RL	See Bias Table 1, pg. 10, Pinc= 0 dBm	dB	—	22.9	—
F = 3.3-3.8 GHz						
Insertion Loss, R_X	R_X IL	See Bias Table 1, pg. 10, Pinc= 0 dBm	dB	—	0.56	1.0
Insertion Loss, T_X	T_X IL	See Bias Table 1, pg. 10, Pinc= 0 dBm	dB	—	0.38	0.575
Isolation, ANT To R_X	R_X ISO	See Bias Table 1, pg. 10, Pinc= 0 dBm	dB	33.7	35.9	—
Isolation, ANT To T_X	T_X ISO	See Bias Table 1, pg. 10, Pinc= 0 dBm	dB	13.6	16.1	—
Input Return Loss, T_X	T_X RL	See Bias Table 1, pg. 10, Pinc= 0 dBm	dB	—	27.4	—
Input Return Loss, R_X	R_X RL	See Bias Table 1, pg. 10, Pinc= 0 dBm	dB	—	21.9	—
F = 4.9-5.9 GHz						
Insertion Loss, R_X	R_X IL	See Bias Table 1, pg. 10, Pinc= 0 dBm	dB	—	0.78	—
Insertion Loss, T_X	T_X IL	See Bias Table 1, pg. 10, Pinc= 0 dBm	dB	—	0.52	—
Isolation, ANT To R_X	R_X ISO	See Bias Table 1, pg. 10, Pinc= 0 dBm	dB	—	26.4	—
Isolation, ANT To T_X	T_X ISO	See Bias Table 1, pg. 10, Pinc= 0 dBm	dB	—	11.8	—
Input Return Loss, T_X	T_X RL	See Bias Table 1, pg. 10, Pinc= 0 dBm	dB	—	20.3	—
Input Return Loss, R_X	R_X RL	See Bias Table 1, pg. 10, Pinc= 0 dBm	dB	—	24.2	—

HMIC™ PIN Diode SPDT 50 Watt Switch for 0.05 - 6.0 GHz Higher Power Applications

Rev. V8

Electrical Specifications at +25°C, Characteristic Impedance, 50mA / 25V, $Z_0 = 50 \Omega$

Parameter	Symbol	50mA / 25V Conditions	Units	Min.	Typ.	Max.
F = 900 MHz						
Insertion Loss, R_X	R_X IL	See Bias Table 2, pg. 10, Pinc= 0 dBm	dB	—	0.27	—
Insertion Loss, T_X	T_X IL	See Bias Table 2, pg. 10, Pinc= 0 dBm	dB	—	0.22	—
Isolation, ANT To R_X	R_X ISO	See Bias Table 2, pg. 10, Pinc= 0 dBm	dB	—	53.3	—
Isolation, ANT To T_X	T_X ISO	See Bias Table 2, pg. 10, Pinc= 0 dBm	dB	—	27.4	—
F = 1800 MHz						
Insertion Loss, R_X	R_X IL	See Bias Table 2, pg. 10, Pinc= 0 dBm	dB	—	0.32	—
Insertion Loss, T_X	T_X IL	See Bias Table 2, pg. 10, Pinc= 0 dBm	dB	—	0.27	—
Isolation, ANT To R_X	R_X ISO	See Bias Table 2, pg. 10, Pinc= 0 dBm	dB	—	50.2	—
Isolation, ANT To T_X	T_X ISO	See Bias Table 2, pg. 10, Pinc= 0 dBm	dB	—	21.6	—
F = 2010 MHz						
Insertion Loss, R_X	R_X IL	See Bias Table 2, pg. 10, Pinc= 0 dBm	dB	—	0.34	—
Insertion Loss, T_X	T_X IL	See Bias Table 2, pg. 10, Pinc= 0 dBm	dB	—	0.28	—
Isolation, ANT To R_X	R_X ISO	See Bias Table 2, pg. 10, Pinc= 0 dBm	dB	—	45.5	—
Isolation, ANT To T_X	T_X ISO	See Bias Table 2, pg. 10, Pinc= 0 dBm	dB	—	20.1	—
Input Return Loss, T_X	T_X RL	See Bias Table 2, pg. 10, Pinc= 0 dBm	dB	—	33.1	—
Input Return Loss, R_X	R_X RL	See Bias Table 2, pg. 10, Pinc= 0 dBm	dB	—	24.1	—

HMIC™ PIN Diode SPDT 50 Watt Switch for 0.05 - 6.0 GHz Higher Power Applications

Rev. V8

Electrical Specifications at +25°C, Characteristic Impedance, 50mA / 25V, $Z_0 = 50 \Omega$

Parameter	Symbol	50mA / 25V Conditions	Units	Min.	Typ.	Max.
F = 2.3-2.7 GHz						
Insertion Loss, R_X	R_X IL	See Bias Table 2, pg. 10, Pinc= 0 dBm	dB	—	0.38	—
Insertion Loss, T_X	T_X IL	See Bias Table 2, pg. 10, Pinc= 0 dBm	dB	—	0.30	—
Isolation, ANT To R_X	R_X ISO	See Bias Table 2, pg. 10, Pinc= 0 dBm	dB	—	41.8	—
Isolation, ANT To T_X	T_X ISO	See Bias Table 2, pg. 10, Pinc= 0 dBm	dB	—	18.7	—
Input Return Loss, T_X	T_X RL	See Bias Table 2, pg. 10, Pinc= 0 dBm	dB	—	31.3	—
Input Return Loss, R_X	R_X RL	See Bias Table 2, pg. 10, Pinc= 0 dBm	dB	—	22.8	—
F = 3.3-3.8 GHz						
Insertion Loss, R_X	R_X IL	See Bias Table 2, pg. 10, Pinc= 0 dBm	dB	—	0.47	—
Insertion Loss, T_X	T_X IL	See Bias Table 2, pg. 10, Pinc= 0 dBm	dB	—	0.33	—
Isolation, ANT To R_X	R_X ISO	See Bias Table 2, pg. 10, Pinc= 0 dBm	dB	—	36.2	—
Isolation, ANT To T_X	T_X ISO	See Bias Table 2, pg. 10, Pinc= 0 dBm	dB	—	16.2	—
Input Return Loss, T_X	T_X RL	See Bias Table 2, pg. 10, Pinc= 0 dBm	dB	—	28.0	—
Input Return Loss, R_X	R_X RL	See Bias Table 2, pg. 10, Pinc= 0 dBm	dB	—	21.8	—
F = 4.9-5.9 GHz						
Insertion Loss, R_X	R_X IL	See Bias Table 2, pg. 10, Pinc= 0 dBm	dB	—	0.72	—
Insertion Loss, T_X	T_X IL	See Bias Table 2, pg. 10, Pinc= 0 dBm	dB	—	0.48	—
Isolation, ANT To R_X	R_X ISO	See Bias Table 2, pg. 10, Pinc= 0 dBm	dB	—	26.6	—
Isolation, ANT To T_X	T_X ISO	See Bias Table 2, pg. 10, Pinc= 0 dBm	dB	—	11.8	—
Input Return Loss, T_X	T_X RL	See Bias Table 2, pg. 10, Pinc= 0 dBm	dB	—	20.5	—
Input Return Loss, R_X	R_X RL	See Bias Table 2, pg. 10, Pinc= 0 dBm	dB	—	24.2	—

HMIC™ PIN Diode SPDT 50 Watt Switch for 0.05 - 6.0 GHz Higher Power Applications

Rev. V8

Electrical Specifications at +25°C, Characteristic Impedance, 50mA / 25V, $Z_0 = 50 \Omega$

Parameter	Symbol	50mA / 25V Conditions	Units	Min.	Typ.	Max.
T_X Input P1dB ³	T_X P1dB	2010 MHz, T_X to Antenna	dBm	—	>45.5	—
T_X 2 nd Harmonic	T_X 2F ₀	2010 MHz, Pin = + 30 dBm	dBc	—	80	—
T_X 3 rd Harmonic	T_X 3F ₀	2010 MHz, Pin = + 30 dBm	dBc	—	95	—
T_X Input Third Order Intercept Point	T_X IIP3	Pi= +10dBm, F1 = 2010 MHz, F2 = 2020 MHz	dBm	—	>64	—
T_X C.W. Input Power ³	T_X Pinc	F = 2010 MHz	dBm W	—	47 50	—
R_X C.W. Input Power	R_X Pinc	F = 2010 MHz	dBm W	—	41.5 14	—
T_X RF Switching Speed	t_{RF}	F = 2010 MHz (10-90% RF Voltage) 1MHz Rep Rate in Modulating Mode	ns	—	200	—

Parameter	Symbol	50mA / 25V Conditions	Units	Min.	Typ.	Max.
T_X Input P1dB	T_X P1dB	3.5 GHz, T_X to Antenna	dBm	—	>45	—
T_X 2 nd Harmonic	T_X 2F ₀	3.5 GHz, Pin = + 30 dBm	dBc	—	88	—
T_X 3 rd Harmonic	T_X 3F ₀	3.5 GHz, Pin = + 30 dBm	dBc	—	105	—
T_X Input Third Order Intercept Point	T_X IIP3	Pi= +10dBm, F1 = 3.500 GHz, F2 = 3.510 GHz	dBm	—	>64	—
R_X C.W. Input Power	R_X Pinc	F = 3.5 GHz	dBm W	—	40.5 11	—
T_X RF Switching Speed	t_{RF}	F = 3.5 GHz (10-90% RF Voltage) 1MHz Rep Rate in Modulating Mode	ns	—	200	—

Electrical Specifications at +25°C, Characteristic Impedance, 50mA / 25V, $Z_0 = 50 \Omega$

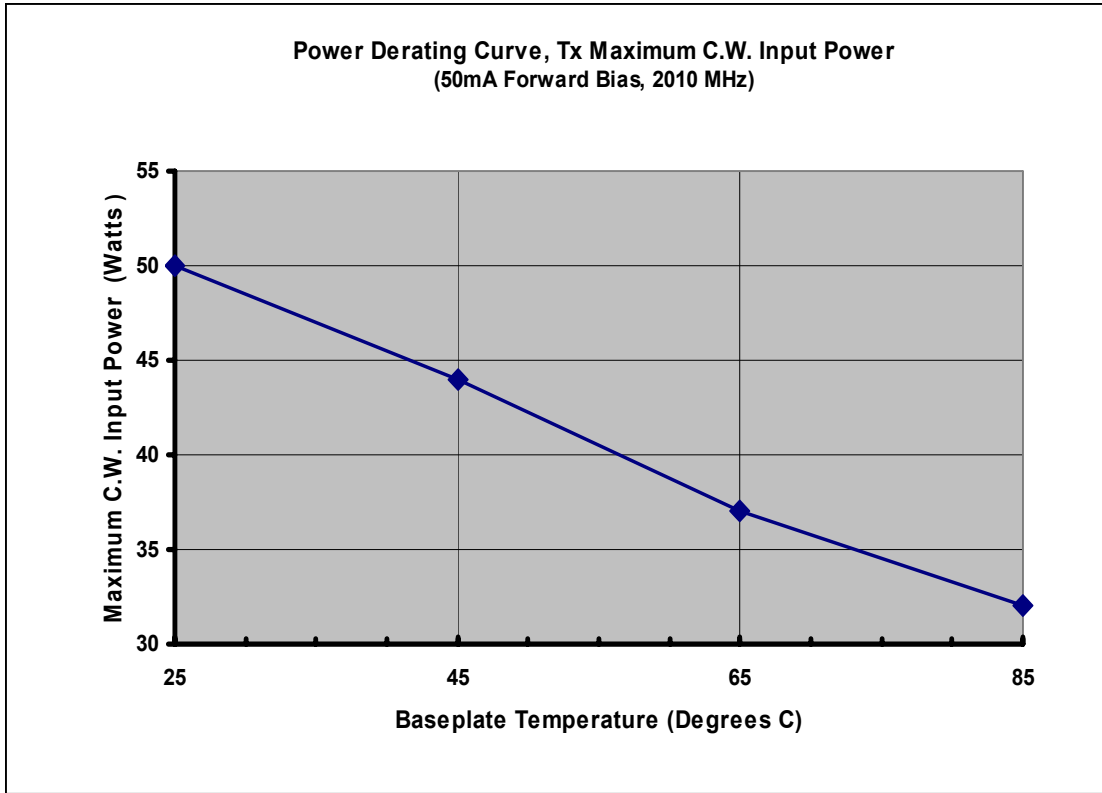

Note that this part must be held to a constant baseplate temperature to achieve the power handling results specified above. Adding a heatsink to the baseplate will improve performance to values greater than shown here. The increase in maximum input power from using a heatsink depends on the specific heatsink design.

With a sample board mounted onto a heatsink of dimensions and fins shown below, this switch can handle up to 35 Watts C.W. of incident power.

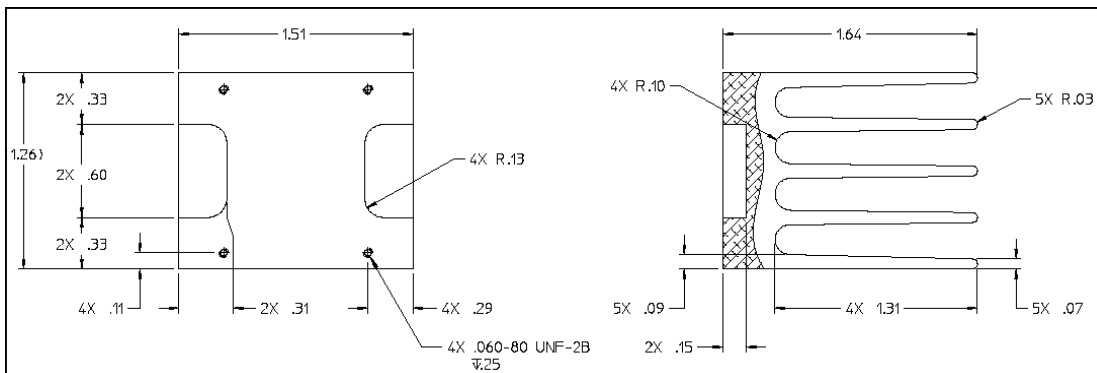

T_x Performance Curves at +25°C, Characteristic Impedance, Z₀ = 50 Ω

Tx Insertion Loss
20mA & 50mA Forward Bias

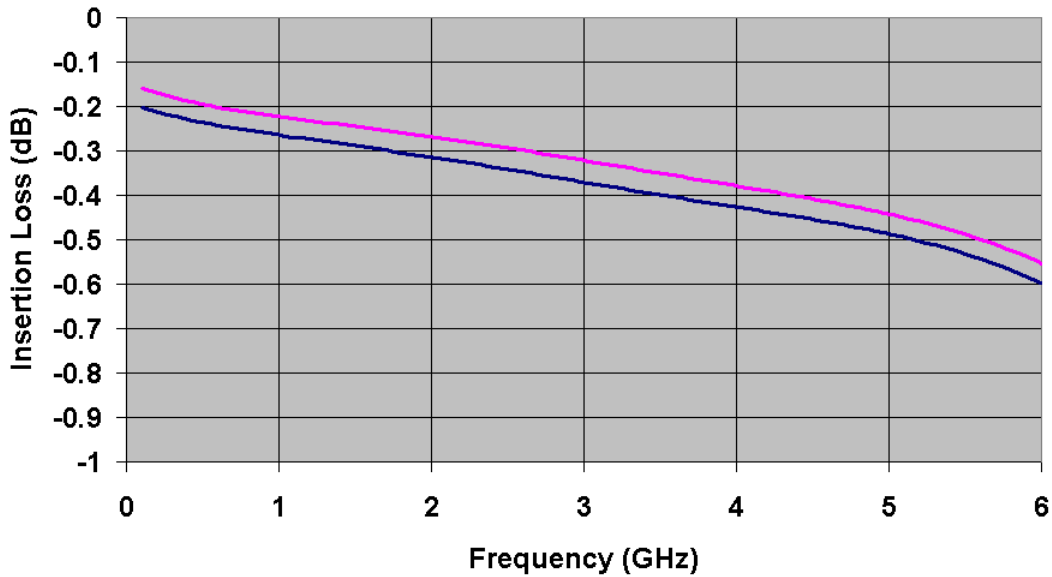

Tx Isolation
5V & 25V Reverse Bias

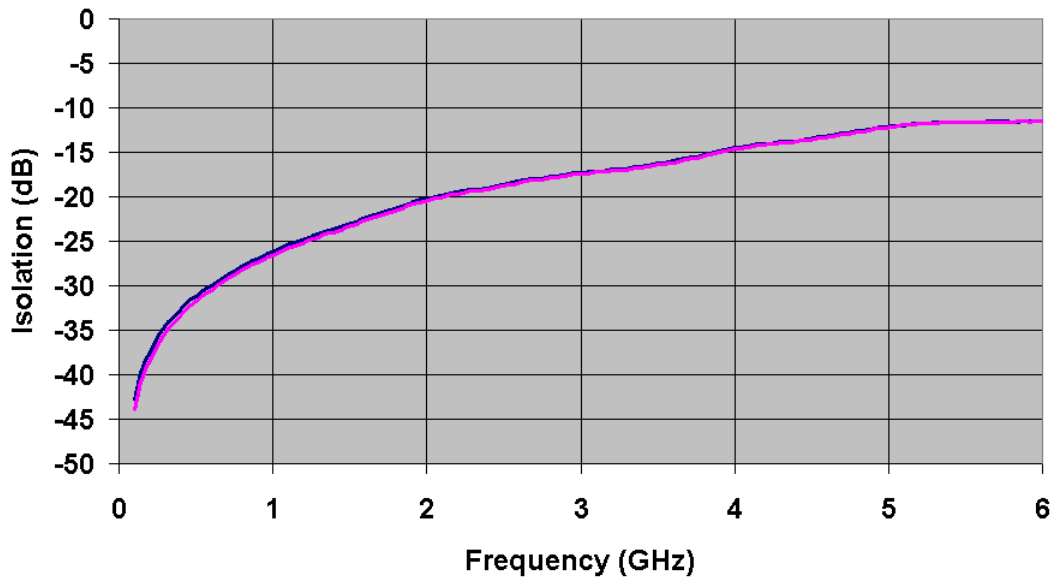

R_x Performance Curves at +25°C, Characteristic Impedance, Z₀ = 50 Ω

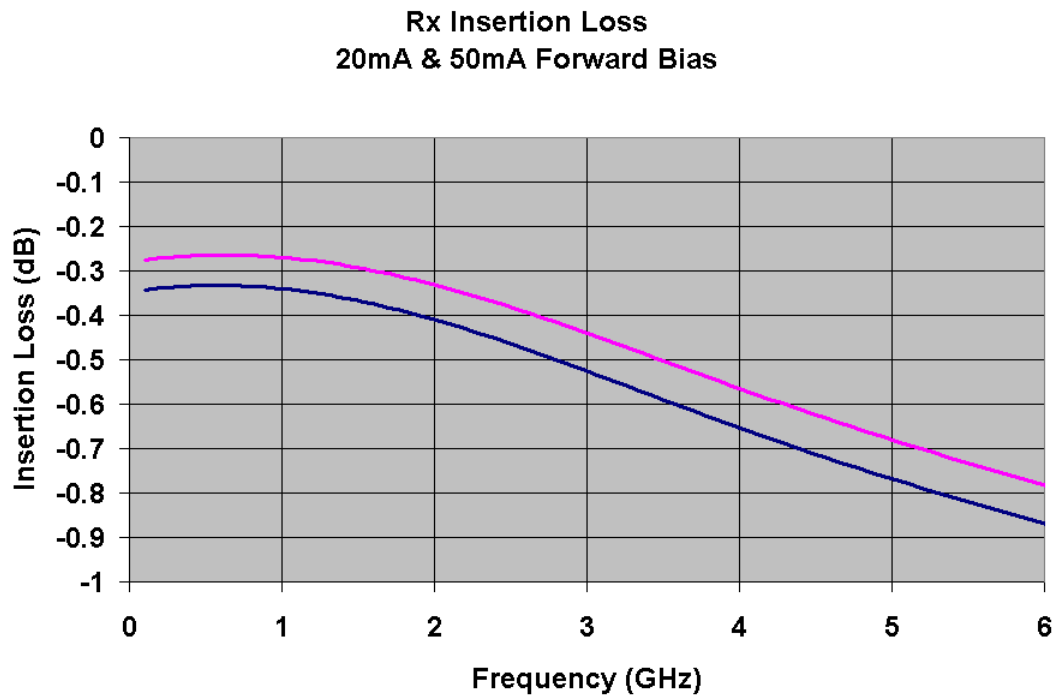
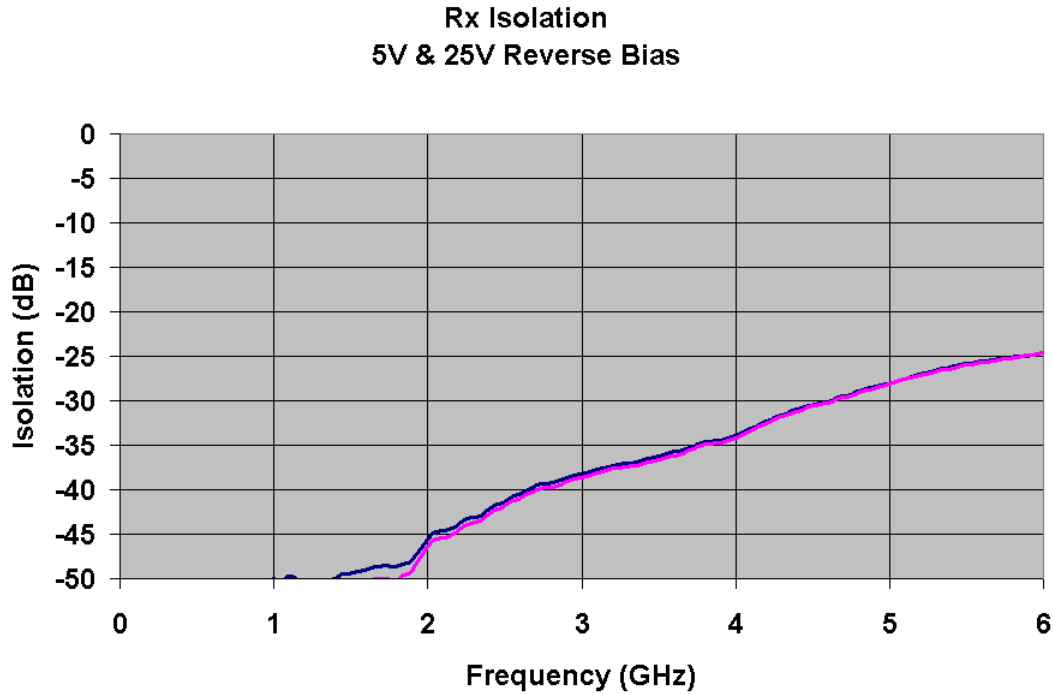

Bias Diagrams & Tables

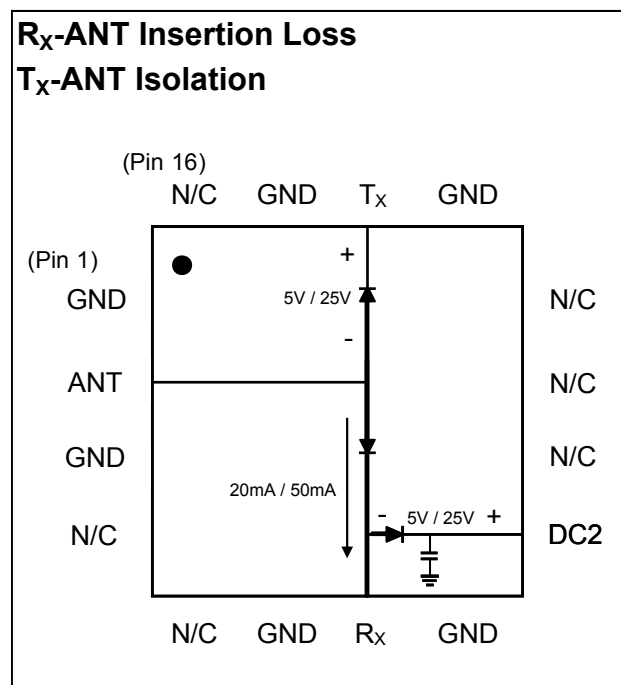
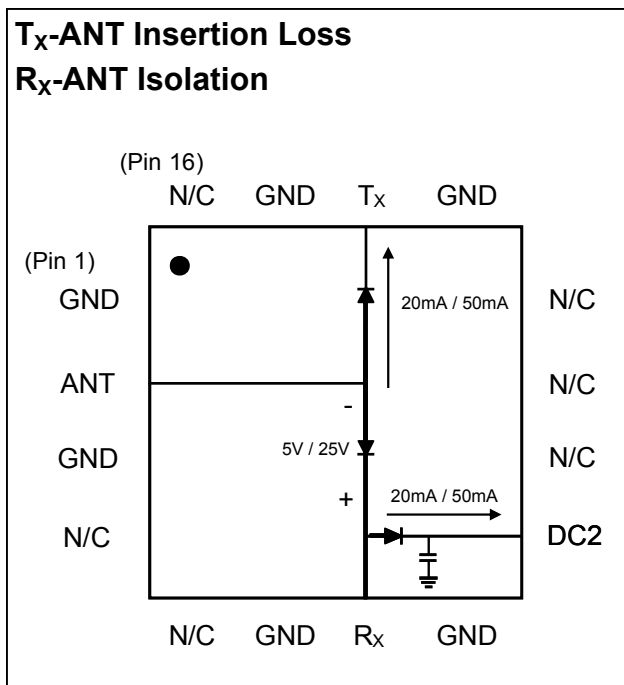

Bias Table 1	T _x	R _x	DC2	ANT
	Pin 14	Pin 7	Pin 9	Pin 2
T _x -ANT Insertion Loss	-20 mA	+5V, 0 mA	-20 mA	0V
R _x -ANT Isolation				
R _x -ANT Insertion Loss	+5V, 0 mA	-20 mA	+5V, 0 mA	0V
T _x -ANT Isolation				

Bias Table 2	T _x	R _x	DC2	ANT
	Pin 14	Pin 7	Pin 9	Pin 2
T _x -ANT Insertion Loss	-50 mA	+25V, 0 mA	-50 mA	0V
R _x -ANT Isolation				
R _x -ANT Insertion Loss	+25V, 0 mA	-50 mA	+25V, 0 mA	0V
T _x -ANT Isolation				

***Note - Diode Based Products require different minimum reverse bias voltages depending on the frequency and incident power levels. More details can be found on page 11 of this datasheet.**

MASW-000834 Minimum Required Reverse Bias Voltage

Minimum reverse bias voltage on a PIN diode based product varies with frequency of operation and incident power levels. As a rule of thumb, a designer can always use the magnitude of the peak RF voltage or empirically locate lower bias values than the peak RF voltage magnitude. However, it has been shown that lower DC voltages can be used depending on the RF environment in which a diode is placed. In the plot below, the minimum required reverse voltage vs. frequency is shown for an incident RF power of 50 Watts. This trend line will shift lower if the incident RF power is decreased. The biasing values have not been verified through measurement at M/A-COM Technology Solutions. As a result, please use the data below as a guide only for biasing requirements as this data is based solely on generic PIN diode equations.⁴

Please be cautious in that lower reverse bias levels can degrade isolation and distortion in a PIN diode based product.

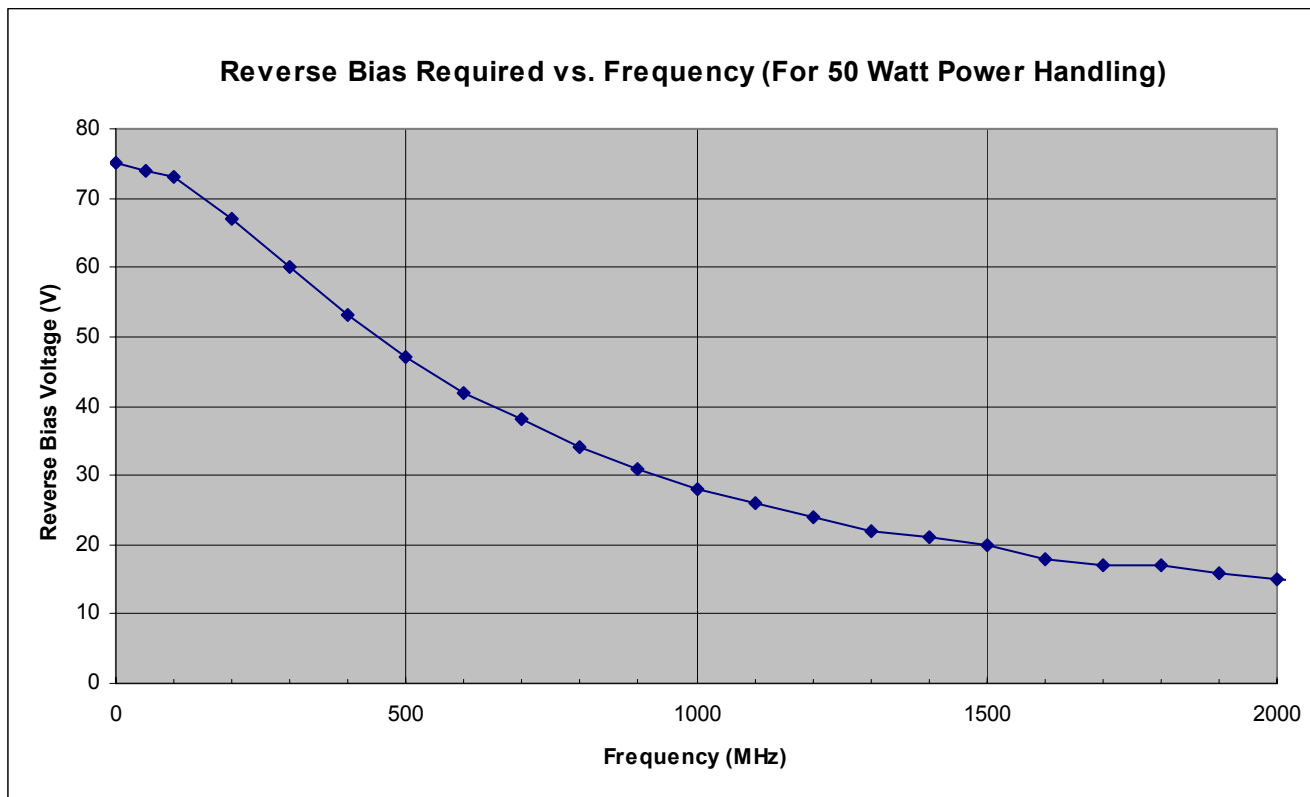

4. R. Caverly and G. Hiller, "Establishing the Minimum Reverse Bias for a P-I-N Diode in a High Power Switch," IEEE Transactions on Microwave Theory and Techniques, Vol.38, No.12, December 1990

Данный компонент на территории Российской Федерации

Вы можете приобрести в компании MosChip.

Для оперативного оформления запроса Вам необходимо перейти по данной ссылке:

<http://moschip.ru/get-element>

Вы можете разместить у нас заказ для любого Вашего проекта, будь то серийное производство или разработка единичного прибора.

В нашем ассортименте представлены ведущие мировые производители активных и пассивных электронных компонентов.

Нашей специализацией является поставка электронной компонентной базы двойного назначения, продукции таких производителей как XILINX, Intel (ex.ALTERA), Vicor, Microchip, Texas Instruments, Analog Devices, Mini-Circuits, Amphenol, Glenair.

Сотрудничество с глобальными дистрибьюторами электронных компонентов, предоставляет возможность заказывать и получать с международных складов практически любой перечень компонентов в оптимальные для Вас сроки.

На всех этапах разработки и производства наши партнеры могут получить квалифицированную поддержку опытных инженеров.

Система менеджмента качества компании отвечает требованиям в соответствии с ГОСТ Р ИСО 9001, ГОСТ РВ 0015-002 и ЭС РД 009

Офис по работе с юридическими лицами:

105318, г.Москва, ул.Щербаковская д.3, офис 1107, 1118, ДЦ «Щербаковский»

Телефон: +7 495 668-12-70 (многоканальный)

Факс: +7 495 668-12-70 (доб.304)

E-mail: info@moschip.ru

Skype отдела продаж:

moschip.ru

moschip.ru_4

moschip.ru_6

moschip.ru_9