

# DC Brush Motor Drivers (36V max.)



## BD623xxx Series

### ●General Description

These H-bridge drivers are full bridge drivers for brush motor applications. Each IC can operate at a wide range of power supply voltages (from 6V to 32V), with output currents of up to 2A. MOS transistors in the output stage allow PWM speed control. The integrated VREF voltage control function allows direct replacement of deprecated motor driver ICs. These highly efficient H-bridge driver ICs facilitate low-power consumption design.

### ●Features

- Built-in, selectable one channel or two channels configuration
- VREF voltage setting pin enables PWM duty control
- Cross-conduction prevention circuit
- Four protection circuits provided: OCP, OVP, TSD and UVLO

### ●Applications

VTR; CD/DVD players; audio-visual equipment; optical disc drives; PC peripherals; OA equipments

### ●Key Specifications

- Supply Voltage Range: 36V(Max.)
- Maximum Output Current: 0.5A / 1.0A / 2.0A
- Output ON resistance: 1.5Ω / 1.5Ω / 1.0Ω
- PWM Input frequency range: 20 to 100kHz
- Standby current: 0μA (Typ.)
- Operating temperature range: -40 to 85°C

### ●Packages

- |          | (Typ.) | (Typ.)                       | (Max.) |
|----------|--------|------------------------------|--------|
| SOP8     |        | 5.00mm x 6.20mm x 1.71mm     |        |
| HSOP25   |        | 13.60mm x 7.80mm x 2.11mm    |        |
| HSOP-M28 |        | 18.50mm x 9.90mm x 2.41mm    |        |
| HRP7     |        | 9.395mm x 10.540mm x 2.005mm |        |

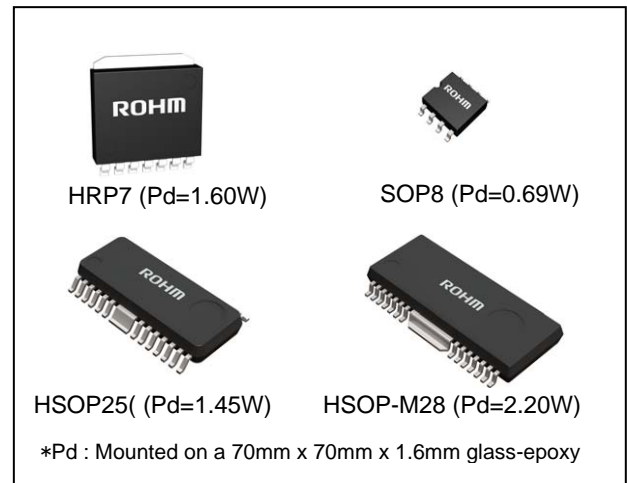

### ●Ordering Information

|   |   |   |   |   |   |   |   |   |   |   |   |
|---|---|---|---|---|---|---|---|---|---|---|---|
| B | D | 6 | 2 | 3 | x | x | x | x | - | x | x |
|---|---|---|---|---|---|---|---|---|---|---|---|

|             |               |                                     |
|-------------|---------------|-------------------------------------|
| Part Number | Package       | Packaging and forming specification |
|             | F : SOP8      | E2: Embossed taping                 |
|             | FP : HSOP25   | (SOP8/HSOP25/HSOP-M28)              |
|             | FM : HSOP-M28 | TR: Embossed taping                 |
|             | HFP : HRP7    | (HRP7)                              |

### ●Lineup

| Rating voltage (Max.) | Channels | Output current (Max.) | Package      |              | Ordeble Part Number |
|-----------------------|----------|-----------------------|--------------|--------------|---------------------|
| 36V                   | 1ch      | 0.5A                  | SOP8         | Reel of 2500 | BD6230F-E2          |
|                       |          | 1.0A                  | HRP7         | Reel of 2000 | BD6231HFP-TR        |
|                       |          |                       | SOP8         | Reel of 2500 | BD6231F-E2          |
|                       | 2.0A     | HRP7                  | Reel of 2000 | BD6232HFP-TR |                     |
|                       | 2ch      | 1.0A                  | HSOP25       | Reel of 2000 | BD6232FP-E2         |
|                       |          |                       | HSOP25       | Reel of 2000 | BD6236FP-E2         |
| HSOP-M28              |          |                       | Reel of 1500 | BD6236FM-E2  |                     |
| 2.0A                  | HSOP-M28 | Reel of 1500          | BD6237FM-E2  |              |                     |

●Block Diagrams / Pin Configurations / Pin Descriptions  
BD6230F / BD6231F

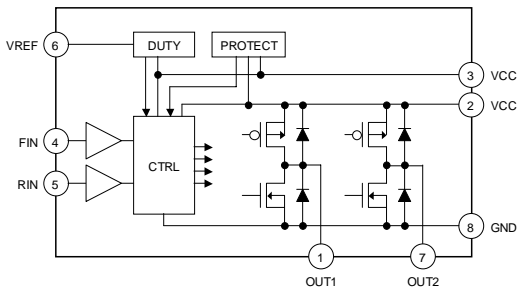

Fig.1 BD6230F / BD6231F

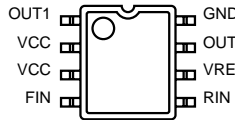

Fig.2 SOP8 (TOP VIEW)

Table 1 BD6230F/BD6231F

| Pin | Name | Function                |
|-----|------|-------------------------|
| 1   | OUT1 | Driver output           |
| 2   | VCC  | Power supply            |
| 3   | VCC  | Power supply            |
| 4   | FIN  | Control input (forward) |
| 5   | RIN  | Control input (reverse) |
| 6   | VREF | Duty setting pin        |
| 7   | OUT2 | Driver output           |
| 8   | GND  | Ground                  |

Note: Use all VCC pin by the same voltage.

BD6231HFP / BD6232HFP

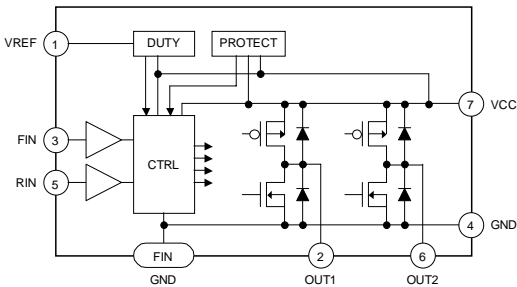

Fig.3 BD6231HFP / BD6232HFP

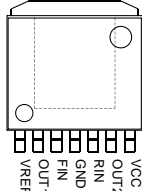

Fig.4 HRP7 (TOP VIEW)

Table 2 BD6231HFP/BD6232HFP

| Pin | Name | Function                |
|-----|------|-------------------------|
| 1   | VREF | Duty setting pin        |
| 2   | OUT1 | Driver output           |
| 3   | FIN  | Control input (forward) |
| 4   | GND  | Ground                  |
| 5   | RIN  | Control input (reverse) |
| 6   | OUT2 | Driver output           |
| 7   | VCC  | Power supply            |
| FIN | GND  | Ground                  |

BD6232FP

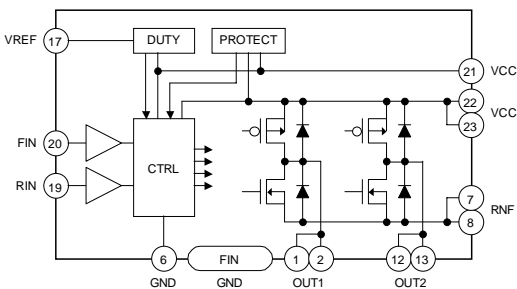

Fig.5 BD6232FP

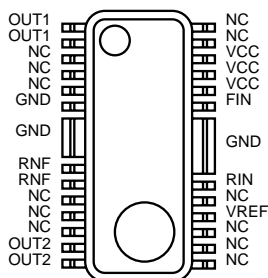

Fig.6 HSOP25 (TOP VIEW)

Table 3 BD6232FP

| Pin   | Name | Function                |
|-------|------|-------------------------|
| 1,2   | OUT1 | Driver output           |
| 6     | GND  | Small signal ground     |
| 7,8   | RNF  | Power stage ground      |
| 12,13 | OUT2 | Driver output           |
| 17    | VREF | Duty setting pin        |
| 19    | RIN  | Control input (reverse) |
| 20    | FIN  | Control input (forward) |
| 21    | VCC  | Power supply            |
| 22,23 | VCC  | Power supply            |
| FIN   | GND  | Ground                  |

Note: All pins not described above are NC pins.  
Note: Use all VCC pin by the same voltage.

● Block Diagrams / Pin Configurations / Pin Descriptions - Continued  
**BD6236FP**

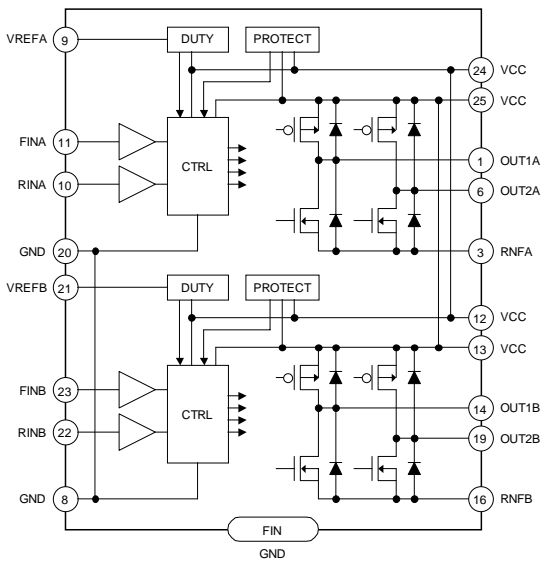

Fig.7 BD6236FP

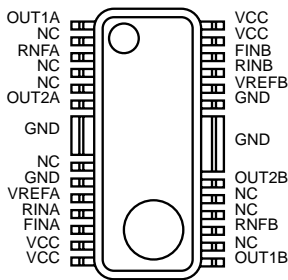

Fig.8 HSOP25 (TOP VIEW)

Table 4 BD6236FP

| Pin | Name  | Function                |
|-----|-------|-------------------------|
| 1   | OUT1A | Driver output           |
| 3   | RNFA  | Power stage ground      |
| 6   | OUT2A | Driver output           |
| 8   | GND   | Small signal ground     |
| 9   | VREFA | Duty setting pin        |
| 10  | RINA  | Control input (reverse) |
| 11  | FINA  | Control input (forward) |
| 12  | VCC   | Power supply            |
| 13  | VCC   | Power supply            |
| 14  | OUT1B | Driver output           |
| 16  | RNFB  | Power stage ground      |
| 19  | OUT2B | Driver output           |
| 20  | GND   | Small signal ground     |
| 21  | VREFB | Duty setting pin        |
| 22  | RINB  | Control input (reverse) |
| 23  | FINB  | Control input (forward) |
| 24  | VCC   | Power supply            |
| 25  | VCC   | Power supply            |
| FIN | GND   | Ground                  |

Note: All pins not described above are NC pins.  
 Note: Use all VCC pin by the same voltage.

●Block Diagrams / Pin Configurations / Pin Descriptions - Continued  
**BD6236FM**

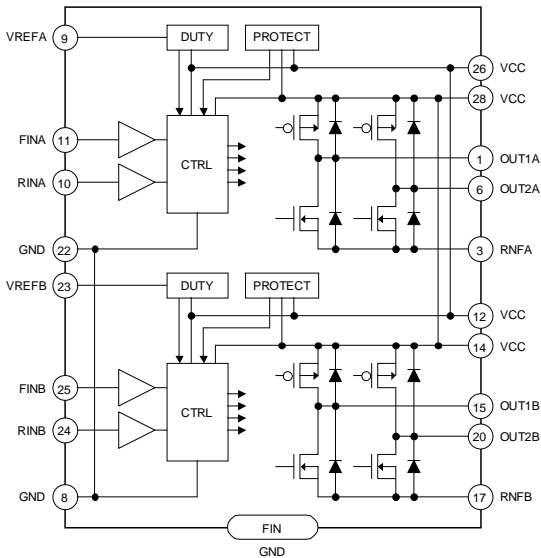

Fig.9 BD6236FM

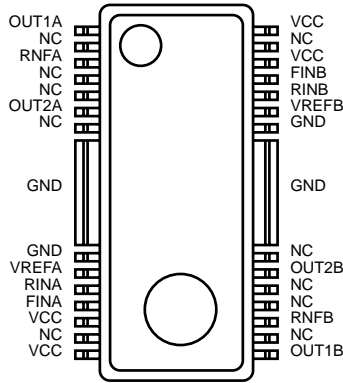

Fig.10 HSOP-M28 (TOP VIEW)

Table 5 BD6236FM

| Pin | Name  | Function                |
|-----|-------|-------------------------|
| 1   | OUT1A | Driver output           |
| 3   | RNFA  | Power stage ground      |
| 6   | OUT2A | Driver output           |
| 8   | GND   | Small signal ground     |
| 9   | VREFA | Duty setting pin        |
| 10  | RINA  | Control input (reverse) |
| 11  | FINA  | Control input (forward) |
| 12  | VCC   | Power supply            |
| 14  | VCC   | Power supply            |
| 15  | OUT1B | Driver output           |
| 17  | RNFB  | Power stage ground      |
| 20  | OUT2B | Driver output           |
| 22  | GND   | Small signal ground     |
| 23  | VREFB | Duty setting pin        |
| 24  | RINB  | Control input (reverse) |
| 25  | FINB  | Control input (forward) |
| 26  | VCC   | Power supply            |
| 28  | VCC   | Power supply            |
| FIN | GND   | Ground                  |

Note: All pins not described above are NC pins.  
 Note: Use all VCC pin by the same voltage.

●Block Diagrams / Pin Configurations / Pin Descriptions - Continued  
**BD6237FM**

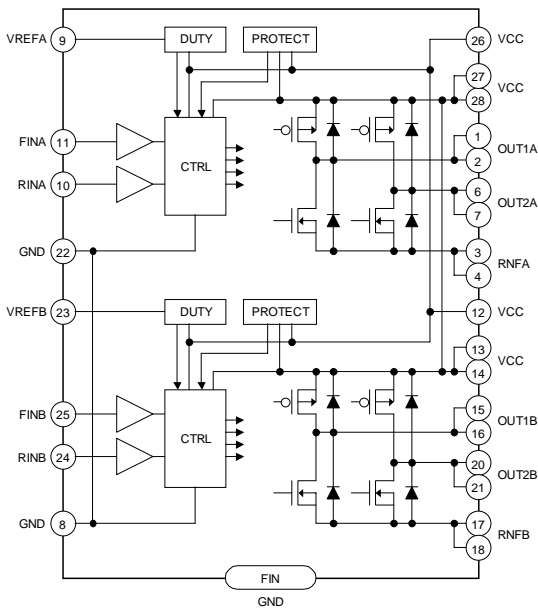

Fig.11 BD6237FM

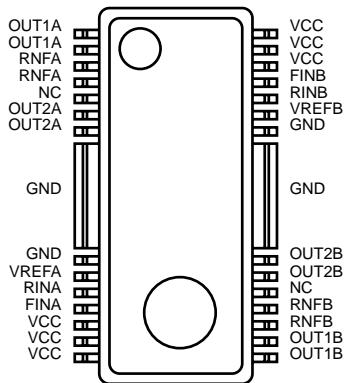

Fig.12 HSOP-M28 (TOP VIEW)

Table 6 BD6237FM

| Pin   | Name  | Function                |
|-------|-------|-------------------------|
| 1,2   | OUT1A | Driver output           |
| 3,4   | RNF A | Power stage ground      |
| 6,7   | OUT2A | Driver output           |
| 8     | GND   | Small signal ground     |
| 9     | VREFA | Duty setting pin        |
| 10    | RINA  | Control input (reverse) |
| 11    | FINA  | Control input (forward) |
| 12    | VCC   | Power supply            |
| 13,14 | VCC   | Power supply            |
| 15,16 | OUT1B | Driver output           |
| 17,18 | RNF B | Power stage ground      |
| 20,21 | OUT2B | Driver output           |
| 22    | GND   | Small signal ground     |
| 23    | VREFB | Duty setting pin        |
| 24    | RINB  | Control input (reverse) |
| 25    | FINB  | Control input (forward) |
| 26    | VCC   | Power supply            |
| 27,28 | VCC   | Power supply            |
| FIN   | GND   | Ground                  |

Note: All pins not described above are NC pins.  
 Note: Use all VCC pin by the same voltage.

● Absolute Maximum Ratings (Ta=25°C, All voltages are with respect to ground)

| Parameter             | Symbol            | Ratings  | Unit |
|-----------------------|-------------------|--|------|
| Supply voltage        | VCC               | 36   | V    |
| Output current        | I <sub>OMAX</sub> | 0.5 * <sup>1</sup> / 1.0 * <sup>2</sup> / 2.0 * <sup>3</sup>                         | A    |
| All other input pins  | V <sub>IN</sub>   | -0.3 to VCC  | V    |
| Operating temperature | T <sub>OPR</sub>  | -40 to +85   | °C   |
| Storage temperature   | T <sub>STG</sub>  | -55 to +150  | °C   |
| Power dissipation     | Pd                | 0.687 * <sup>4</sup> / 1.6 * <sup>5</sup> / 1.45 * <sup>6</sup> / 2.2 * <sup>7</sup> | W    |
| Junction temperature  | T <sub>Jmax</sub> | 150  | °C   |

\*1 BD6230. Do not exceed Pd or ASO.

\*2 BD6231 / BD6236. Do not exceed Pd or ASO.

\*3 BD6232 / BD6237. Do not exceed Pd or ASO.

\*4 SOP8 package. Mounted on a 70mm x 70mm x 1.6mm glass-epoxy board. Derate by 5.5mW/°C above 25°C.

\*5 HRP7 package. Mounted on a 70mm x 70mm x 1.6mm glass-epoxy board. Derate by 12.8mW/°C above 25°C.

\*6 HSOP25 package. Mounted on a 70mm x 70mm x 1.6mm glass-epoxy board. Derate by 11.6mW/°C above 25°C.

\*7 HSOP-M28 package. Mounted on a 70mm x 70mm x 1.6mm glass-epoxy board. Derate by 17.6mW/°C above 25°C.

● Recommended Operating Ratings (Ta=25°C)

| Parameter      | Symbol | Ratings | Unit |
|----------------|--------|---------|------|
| Supply voltage | VCC    | 6 to 32 | V    |
| VREF voltage   | VREF   | 3 to 32 | V    |

● Electrical Characteristics (Unless otherwise specified, Ta=25°C and VCC=VREF=24V)

| Parameter                           | Symbol            | Limits |      |      | Unit | Conditions                              |
|-------------------------------------|-------------------|--------|------|------|------|---|
|                                     |                   | Min.   | Min. | Min. |      |   |
| Supply current (1ch)                | I <sub>CC</sub>   | 0.8    | 1.3  | 2.5  | mA   | Forward / Reverse / Brake               |
| Supply current (2ch)                | I <sub>CC</sub>   | 1.3    | 2.0  | 3.5  | mA   | Forward / Reverse / Brake               |
| Stand-by current                    | I <sub>STBY</sub> | -      | 0    | 10   | μA   | Stand-by                                |
| Input high voltage                  | V <sub>IH</sub>   | 2.0    | -    | -    | V    |   |
| Input low voltage                   | V <sub>IL</sub>   | -      | -    | 0.8  | V    |   |
| Input bias current                  | I <sub>IH</sub>   | 30     | 50   | 100  | μA   | V <sub>IN</sub> =5.0V                   |
| Output ON resistance * <sup>1</sup> | R <sub>ON</sub>   | 1.0    | 1.5  | 2.5  | Ω    | I <sub>O</sub> =0.25A, vertically total |
| Output ON resistance * <sup>2</sup> | R <sub>ON</sub>   | 1.0    | 1.5  | 2.5  | Ω    | I <sub>O</sub> =0.5A, vertically total  |
| Output ON resistance * <sup>3</sup> | R <sub>ON</sub>   | 0.5    | 1.0  | 1.5  | Ω    | I <sub>O</sub> =1.0A, vertically total  |
| VREF bias current                   | I <sub>VREF</sub> | -10    | 0    | 10   | μA   | VREF=VCC                                |
| Carrier frequency                   | F <sub>PWM</sub>  | 20     | 25   | 35   | kHz  | VREF=18V                                |
| Input frequency range               | F <sub>MAX</sub>  | 20     | -    | 100  | kHz  | FIN / RIN                               |

\*1 BD6230

\*2 BD6231 / BD6236

\*3 BD6232 / BD6237

● Typical Performance Curves (Reference data)

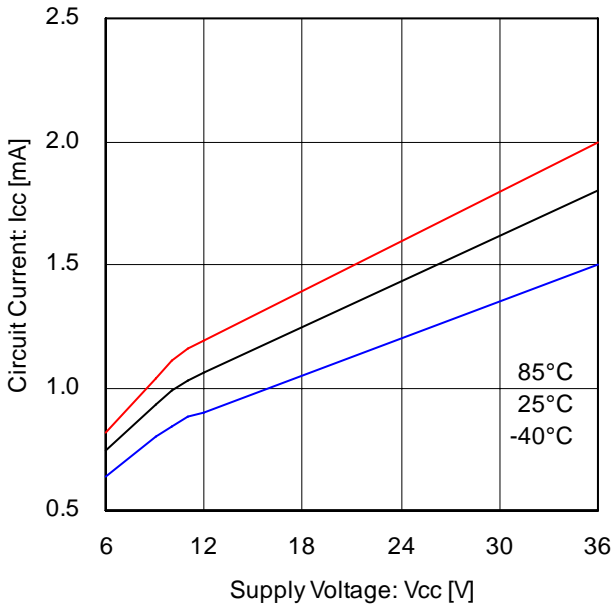

Fig.13 Supply current (1ch)

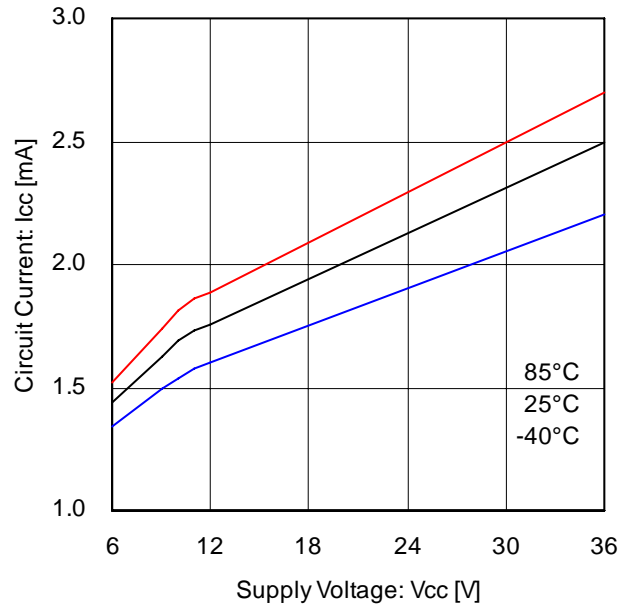

Fig.14 Supply current (2ch)

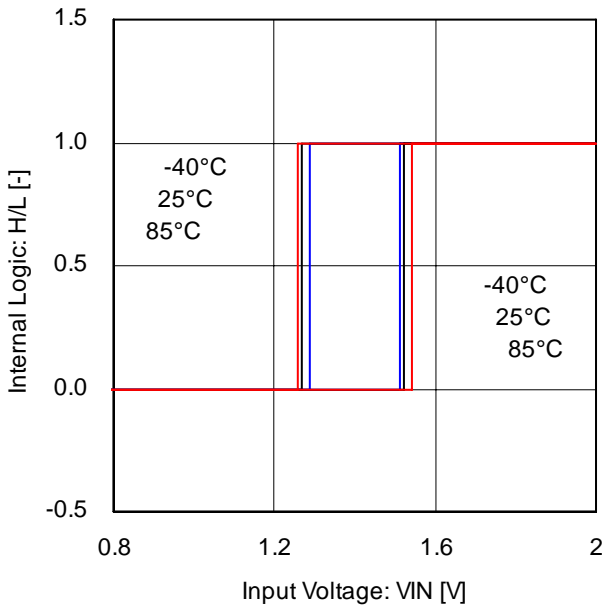

Fig.15 Input threshold voltage

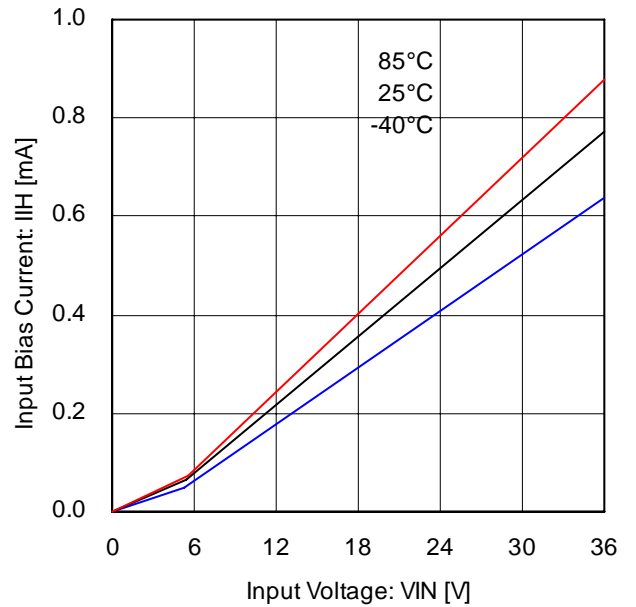

Fig.16 Input bias current

● Typical Performance Curves (Reference data) - Continued

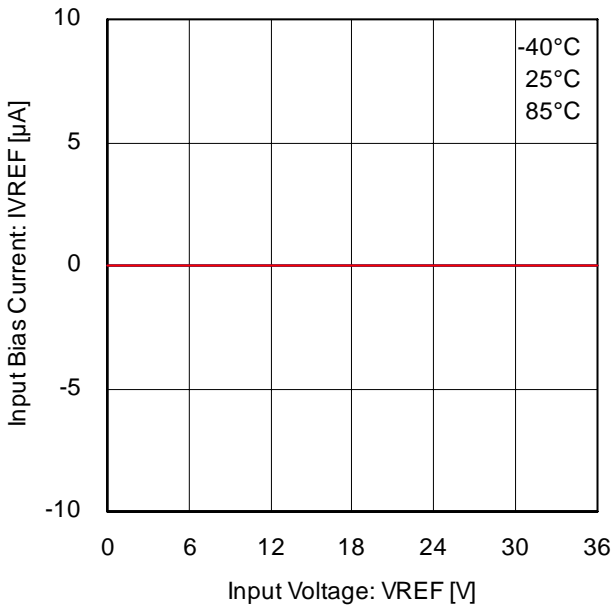

Fig.17 VREF input bias current

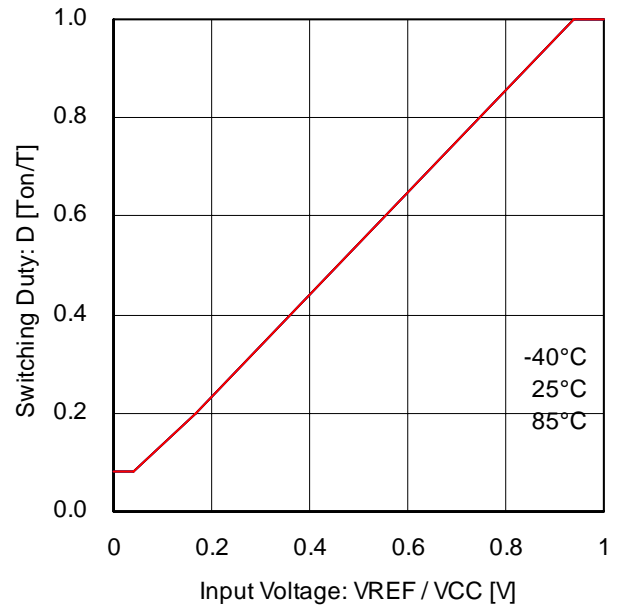

Fig.18 VREF - DUTY (VCC=24V)

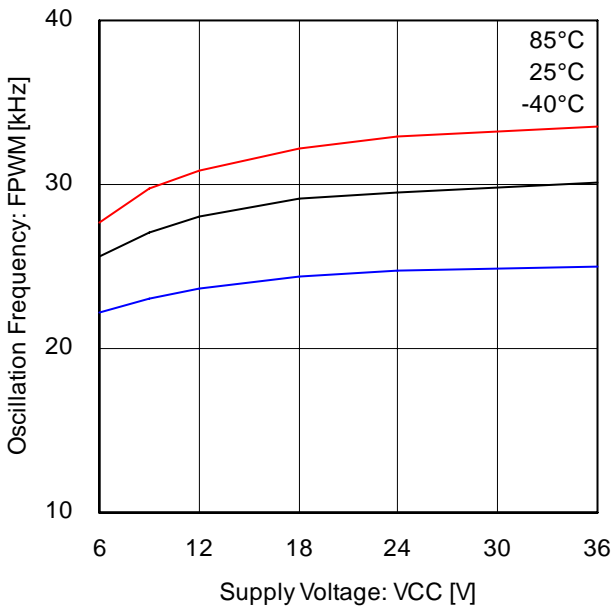

Fig.19 VCC - Carrier frequency

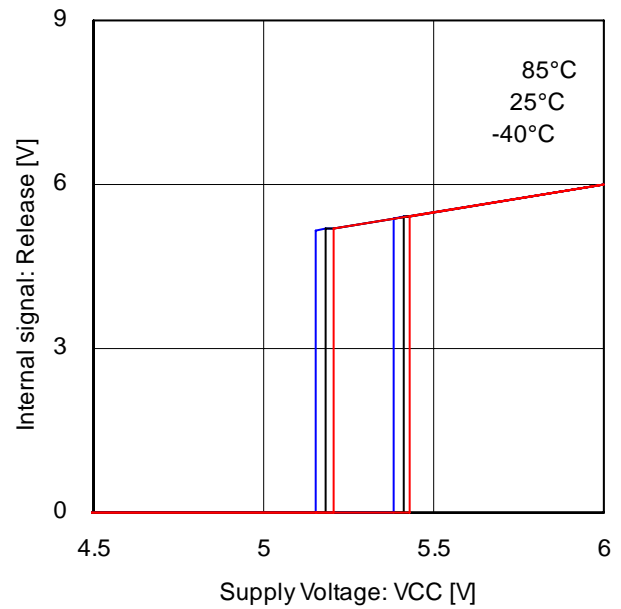

Fig.20 Under voltage lock out



● Typical Performance Curves (Reference data) - Continued

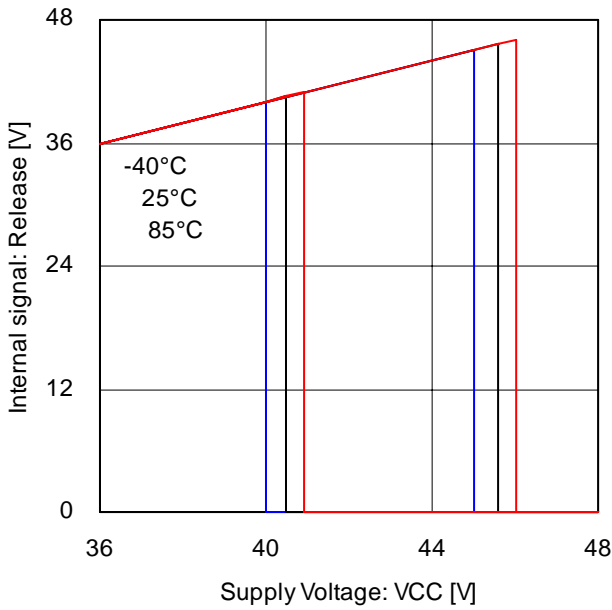

Fig.21 Over voltage protection

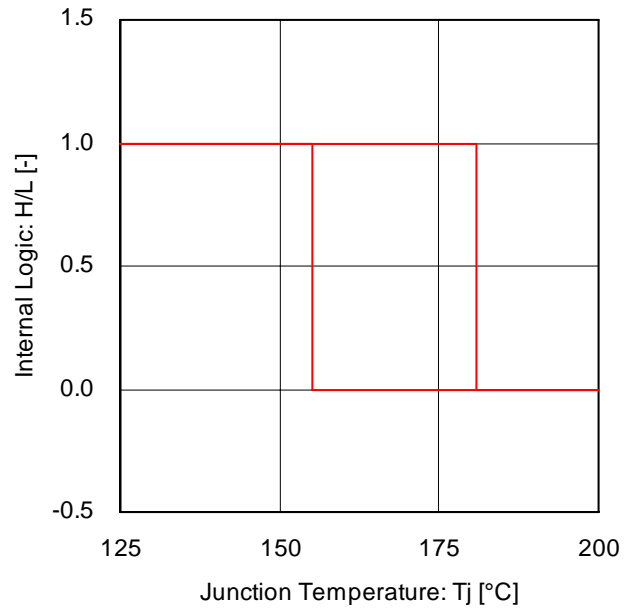

Fig.22 Thermal shutdown

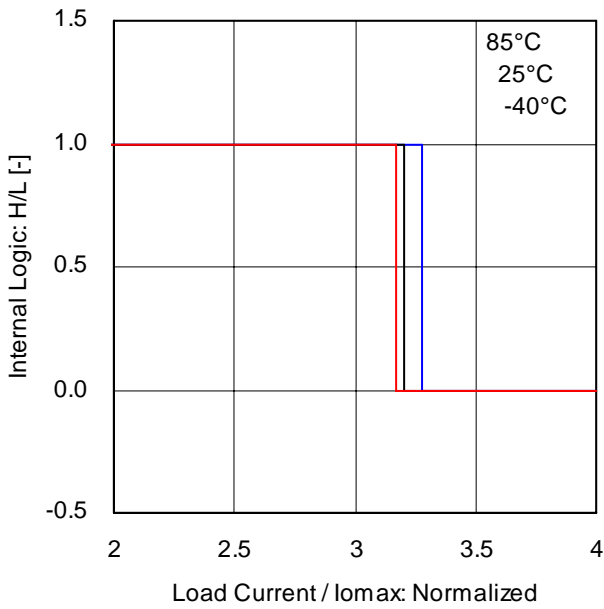

Fig.23 Over current protection (H side)

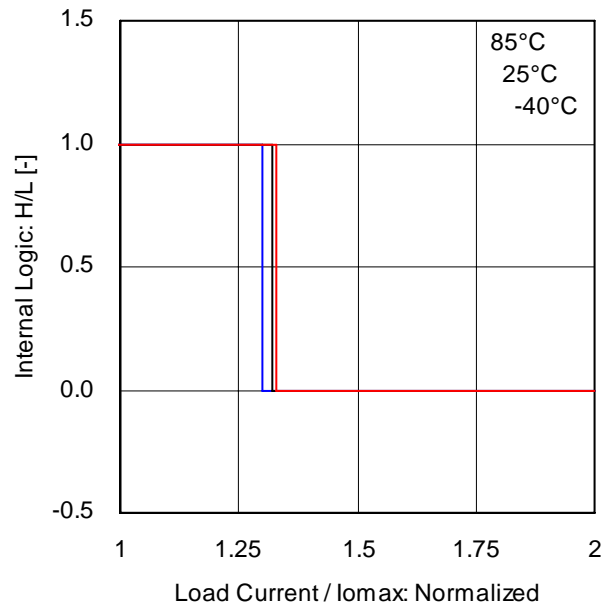

Fig.24 Over current protection (L side)

● Typical Performance Curves (Reference data) – Continued

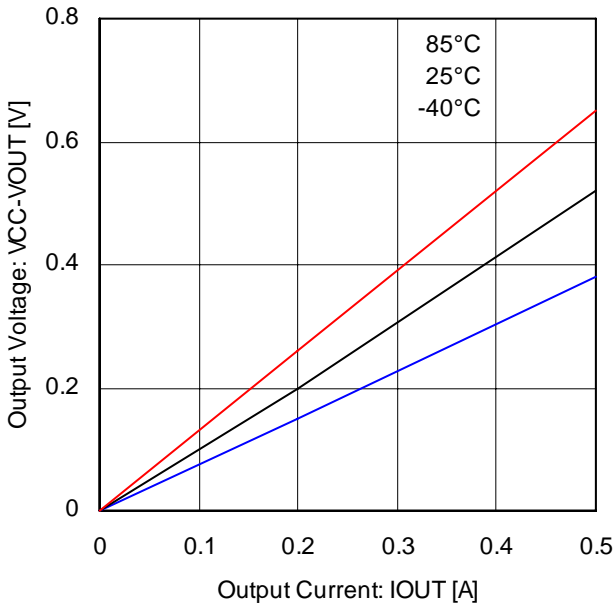

Fig.25 Output high voltage (BD6230)

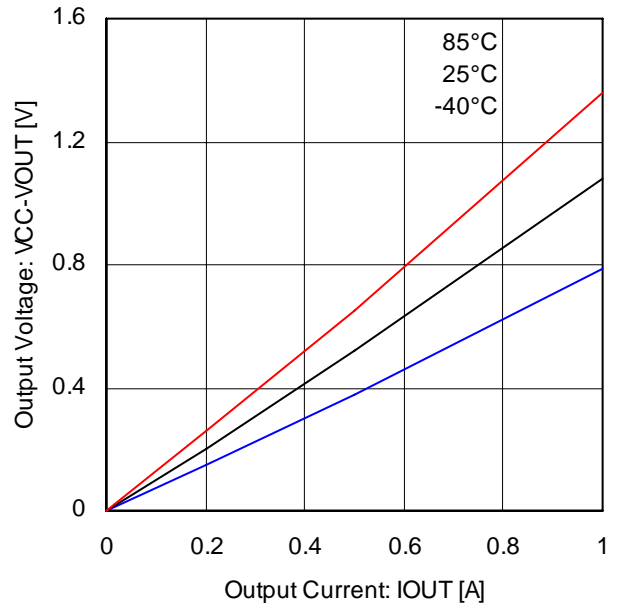

Fig.26 Output high voltage (BD6231/36)

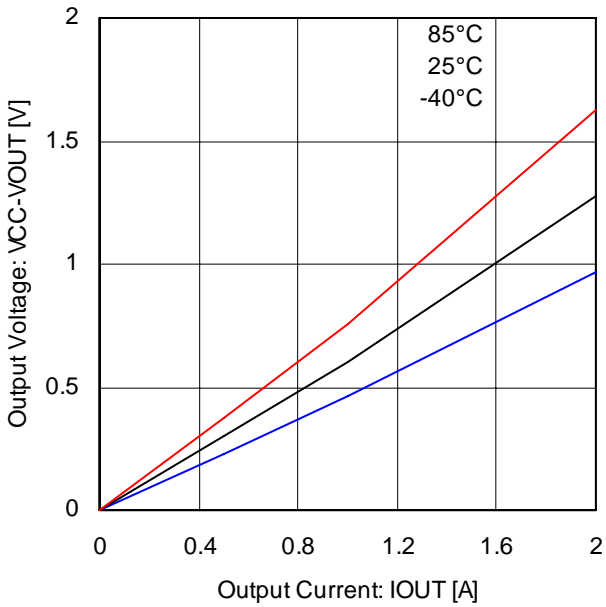

Fig.27 Output high voltage (BD6232/37)

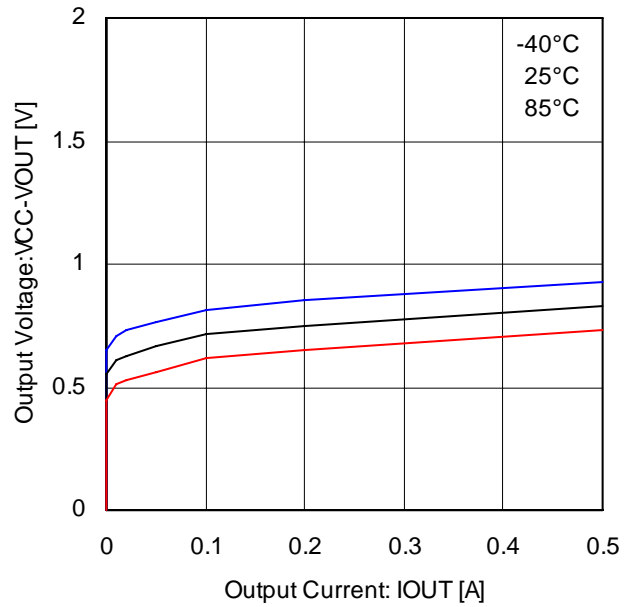

Fig.28 High side body diode (BD6230)

● Typical Performance Curves (Reference data) – Continued

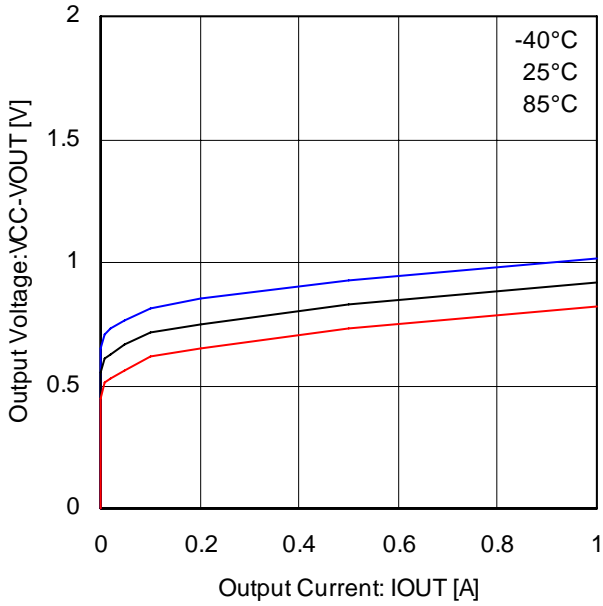

Fig.29 High side body diode (BD6231/36)

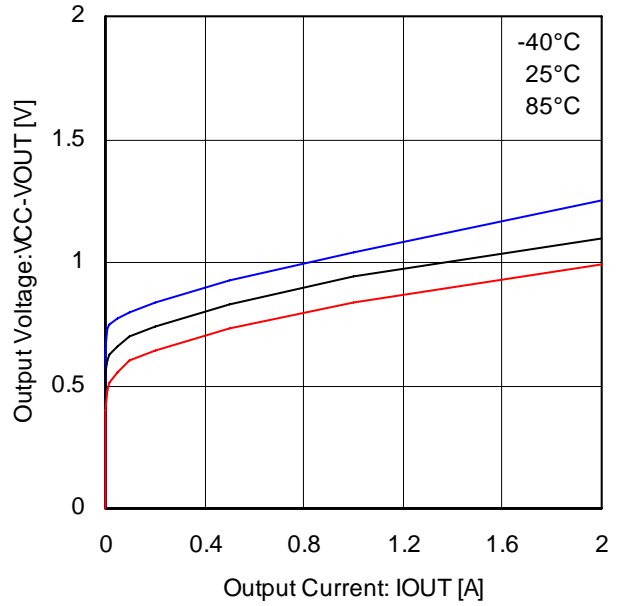

Fig.30 High side body diode (BD6232/37)

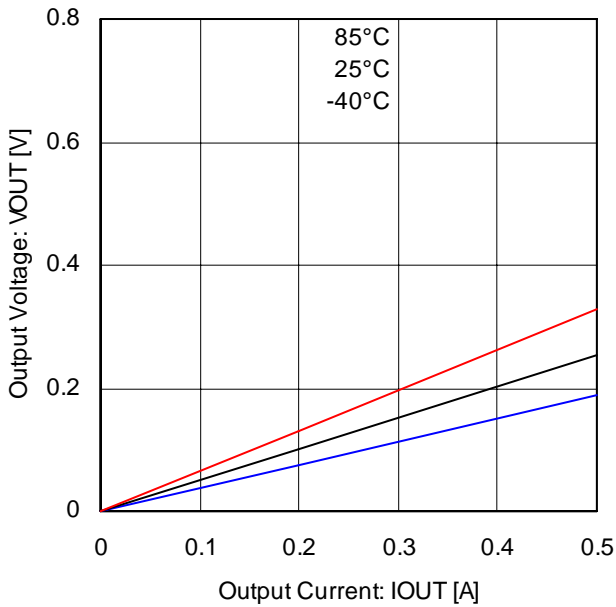

Fig.31 Output low voltage (BD6230)

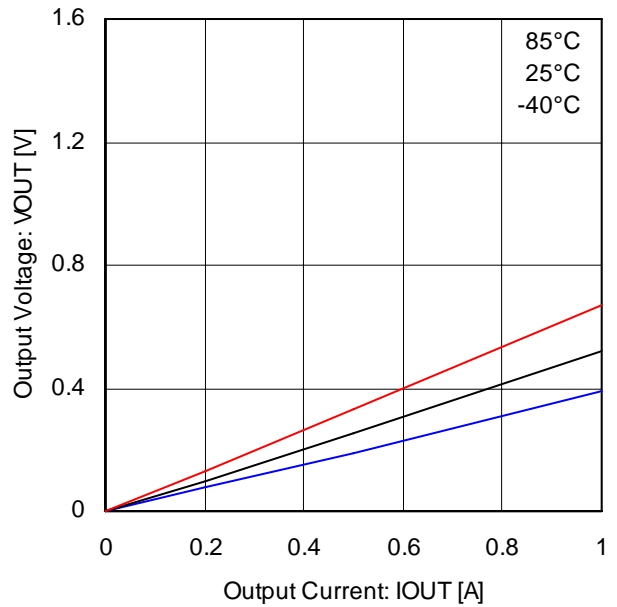

Fig.32 Output low voltage (BD6231/36)

● Typical Performance Curves (Reference data) - Continued

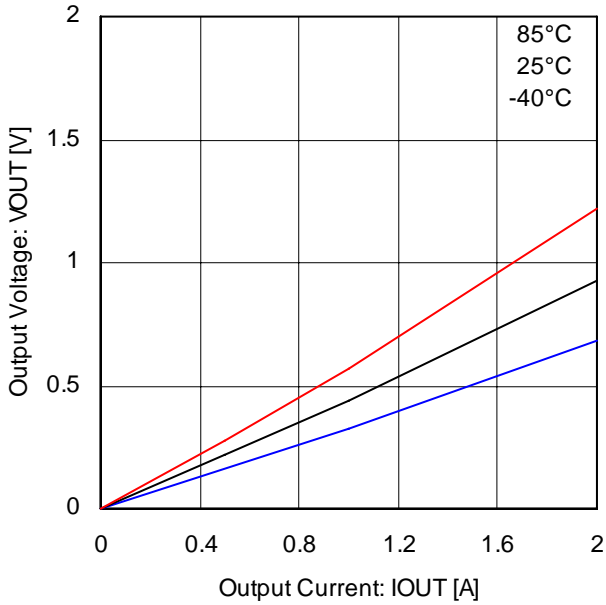

Fig.33 Output low voltage (BD6232/37)

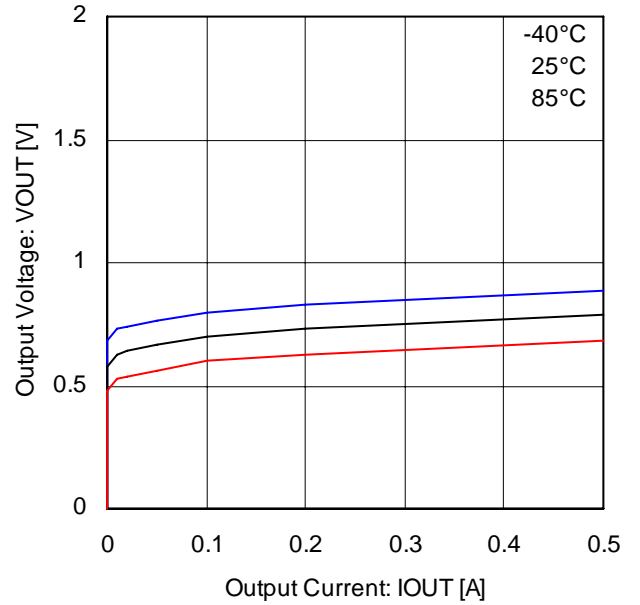

Fig.34 Low side body diode (BD6230)

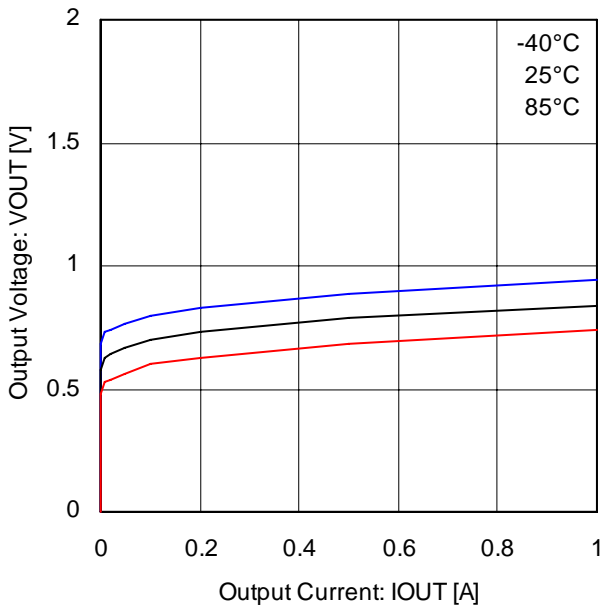

Fig.35 Low side body diode (BD6231/36)

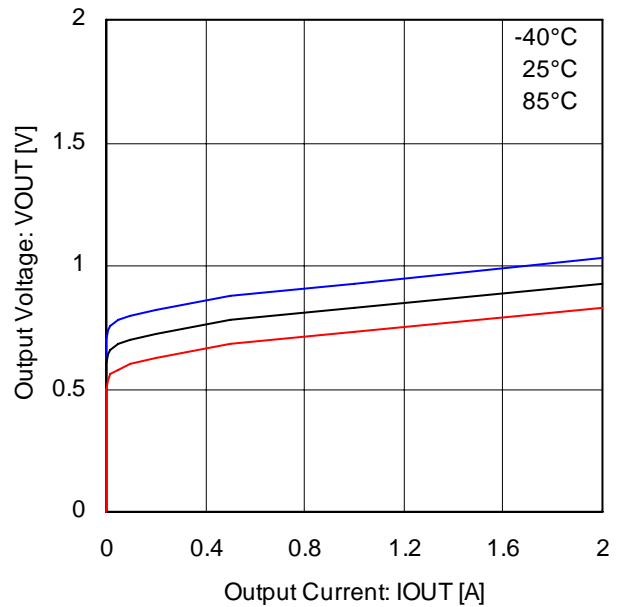

Fig.36 Low side body diode (BD6232/37)

●Functional Descriptions

1) Operation modes

Table 7 Logic table

|   | FIN | RIN | VREF   | OUT1                    | OUT2                    | Operation                    |
|---|-----|-----|--------|-------------------------|-------------------------|------------------------------|
| a | L   | L   | X      | Hi-Z*                   | Hi-Z*                   | Stand-by (idling)            |
| b | H   | L   | VCC    | H                       | L                       | Forward (OUT1 > OUT2)        |
| c | L   | H   | VCC    | L                       | H                       | Reverse (OUT1 < OUT2)        |
| d | H   | H   | X      | L                       | L                       | Brake (stop)                 |
| e | PWM | L   | VCC    | H                       | $\overline{\text{PWM}}$ | Forward (PWM control mode A) |
| f | L   | PWM | VCC    | $\overline{\text{PWM}}$ | H                       | Reverse (PWM control mode A) |
| g | H   | PWM | VCC    | $\overline{\text{PWM}}$ | L                       | Forward (PWM control mode B) |
| h | PWM | H   | VCC    | L                       | $\overline{\text{PWM}}$ | Reverse (PWM control mode B) |
| i | H   | L   | Option | H                       | $\overline{\text{PWM}}$ | Forward (VREF control)       |
| j | L   | H   | Option | $\overline{\text{PWM}}$ | H                       | Reverse (VREF control)       |

\* Hi-Z : all output transistors are off. Please note that this is the state of the connected diodes, which differs from that of the mechanical relay.  
 X : Don't care

a) Stand-by mode

Stand-by operates independently with the VREF pin voltage. In stand-by mode, all internal circuits are turned off, including the output power transistors. Motor output goes to high impedance. When the system is switched to stand-by mode while the motor is running, the system enters an idling state because of the body diodes. However, when the system switches to stand-by from any other mode (except the brake mode), the control logic remains in the high state for at least 50µs before shutting down all circuits.

b) Forward mode

This operating mode is defined as the forward rotation of the motor when the OUT1 pin is high and OUT2 pin is low. When the motor is connected between the OUT1 and OUT2 pins, the current flows from OUT1 to OUT2. To operate in this mode, connect the VREF pin to the VCC pin.

c) Reverse mode

This operating mode is defined as the reverse rotation of the motor when the OUT1 pin is low and OUT2 pin is high. When the motor is connected between the OUT1 and OUT2 pins, the current flows from OUT2 to OUT1. To operate in this mode, connect the VREF pin to the VCC pin.

d) Brake mode

This operating mode is used to quickly stop the motor (short circuit brake). It differs from the stand-by mode because the internal control circuit is operating in the brake mode. Please switch to stand-by mode (rather than the brake mode) to save power and reduce consumption.

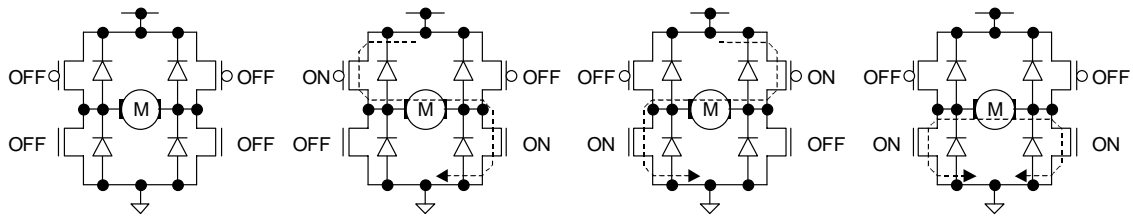

a) Stand-by mode

b) Forward mode

c) Reverse mode

d) Brake mode

Fig.37 Four basic operations (output stage)

e) f) PWM control mode A

The rotational speed of the motor can be controlled by the duty cycle of the PWM signal fed to the FIN pin or the RIN pin. In this mode, the high side output is fixed and the low side output is switching, corresponding to the input signal. The state of the output toggles between "L" and "Hi-Z".

The frequency of the input PWM signal can be between 20kHz and 100kHz. The circuit may not operate properly for PWM frequencies below 20kHz and above 100kHz. Note that control may not be attained by switching on duty at frequencies lower than 20kHz, since the operation functions via the stand-by mode. To operate in this mode, connect the VREF pin to the VCC pin. In addition, establish a current path for the recovery current from the motor, by connecting a bypass capacitor (10µF or higher is recommended) between VCC and ground.

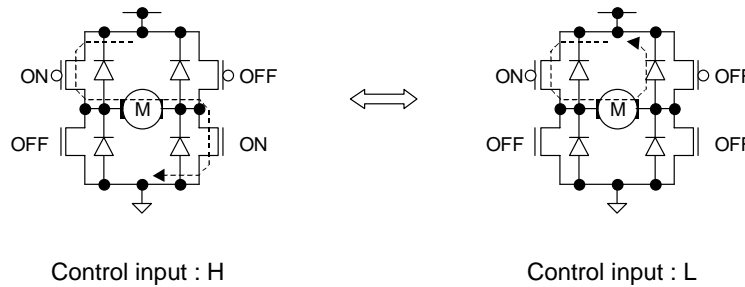

Fig.38 PWM control mode A operation (output stage)

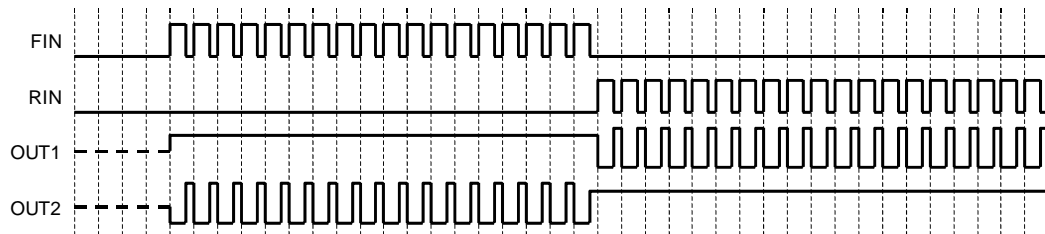

Fig.39 PWM control mode A operation (timing chart)

g) h) PWM control mode B

The rotational speed of the motor can be controlled by the duty cycle of the PWM signal fed to the FIN pin or the RIN pin. In this mode, the low side output is fixed and the high side output is switching, corresponding to the input signal. The state of the output toggles between "L" and "H".

The frequency of the input PWM signal can be between 20kHz and 100kHz. The circuit may not operate properly for PWM frequencies below 20kHz and above 100kHz. To operate in this mode, connect the VREF pin to the VCC pin. In addition, establish a current path for the recovery current from the motor, by connecting a bypass capacitor (10µF or higher is recommended) between VCC and ground.

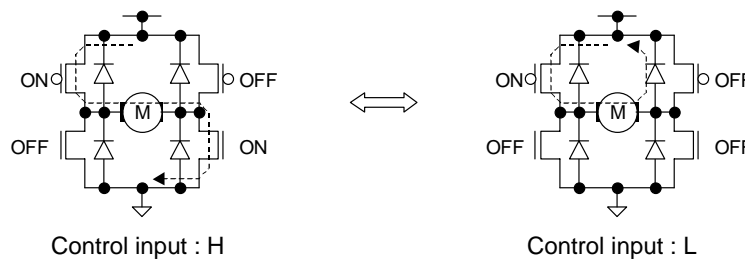

Fig.40 PWM control mode B operation (output stage)

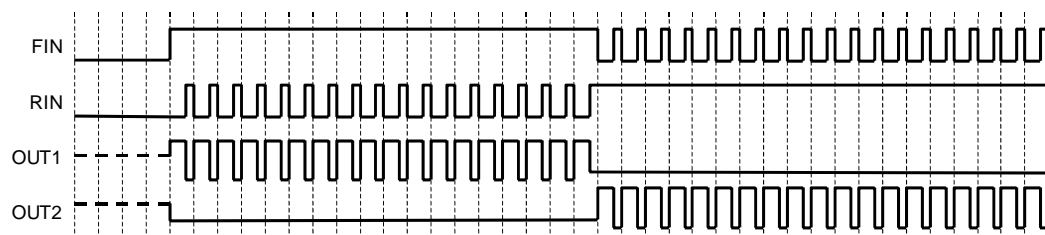

Fig.41 PWM control mode B operation (timing chart)

## i) j) VREF control mode

The built-in VREF duty cycle conversion circuit provides a duty cycle corresponding to the voltage of the VREF pin and the VCC voltage. The function offers the same level of control as the high voltage output setting function in previous models. The duty cycle is calculated by the following equation.

$$\text{DUTY} \approx \text{VREF [V]} / \text{VCC [V]}$$

For example, if VCC voltage is 24V and VREF pin voltage is 18V, the duty cycle is about 75 percent. However, please note that the duty cycle might be limited by the range of the VREF pin voltage (Refer to the operating conditions, shown on page 2). The PWM carrier frequency in this mode is 25kHz (nominal), and the switching operation is the same as the PWM control modes. When operating in this mode, do not input a PWM signal to the FIN and RIN pins. In addition, establish a current path for the recovery current from the motor, by connecting a bypass capacitor (10 $\mu$ F or more is recommended) between VCC and ground.

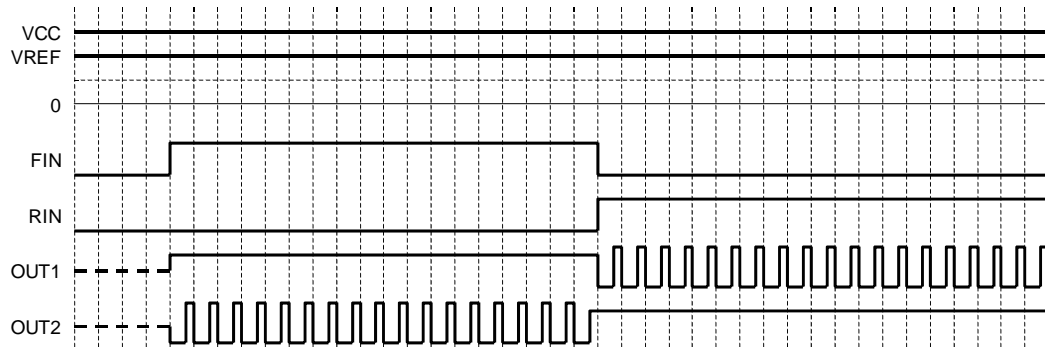

Fig.42 VREF control operation (timing chart)

## 2) Cross-conduction protection circuit

In the full bridge output stage, when the upper and lower transistors are turned on at the same time during high to low or low to high transition, an inrush current flows from the power supply to ground, resulting in a loss. This circuit eliminates the inrush current by providing a dead time (about 400ns, nominal) during the transition.

## 3) Output protection circuits

## a) Under voltage lock out (UVLO) circuit

To ensure the lowest power supply voltage necessary to operate the controller, and to prevent under voltage malfunctions, a UVLO circuit has been built into this driver. When the power supply voltage falls to 5.0V (nominal) or below, the controller forces all driver outputs to high impedance. When the voltage rises to 5.5V (nominal) or above, the UVLO circuit ends the lockout operation and returns the chip to normal operation.

## b) Over voltage protection (OVP) circuit

When the power supply voltage exceeds 45V (nominal), the controller forces all driver outputs to high impedance. The OVP circuit is released and its operation ends when the voltage drops back to 40V (nominal) or below. This protection circuit does not work in the stand-by mode. Also, note that this circuit is supplementary, and thus if it is asserted, the absolute maximum rating will have been exceeded. Therefore, do not continue to use the IC after this circuit is activated, and do not operate the IC in an environment where activation of the circuit is assumed.

c) Thermal shutdown (TSD) circuit

The TSD circuit operates when the junction temperature of the driver exceeds the preset temperature (175°C nominal). At this time, the controller forces all driver outputs to high impedance. Since thermal hysteresis is provided in the TSD circuit, the chip returns to normal operation when the junction temperature falls below the preset temperature (150°C nominal). Thus, it is a self-resetting circuit.

The TSD circuit is designed only to shut the IC off to prevent thermal runaway. It is not designed to protect the IC or guarantee its operation in the presence of extreme heat. Do not continue to use the IC after the TSD circuit is activated, and do not operate the IC in an environment where activation of the circuit is assumed.

d) Over current protection (OCP) circuit

To protect this driver IC from ground faults, power supply line faults and load short circuits, the OCP circuit monitors the output current for the circuit's monitoring time (10µs, nominal). When the protection circuit detects an over current, the controller forces all driver outputs to high impedance during the off time (290µs, nominal). The IC returns to normal operation after the off time period has elapsed (self-returning type). At the two channels type, this circuit works independently for each channel.

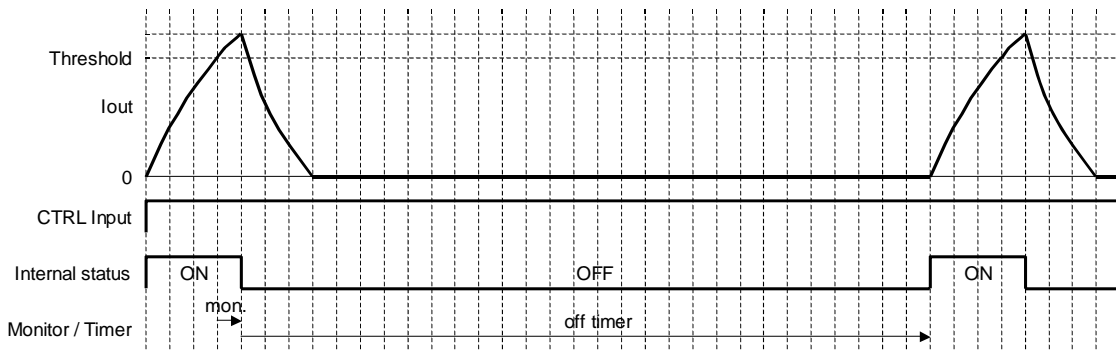

Fig.43 Over current protection (timing chart)

● I/O equivalent circuit

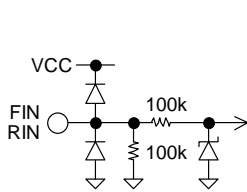

Fig.44 FIN / RIN

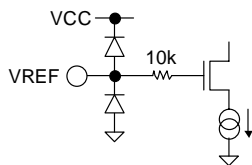

Fig.45 VREF

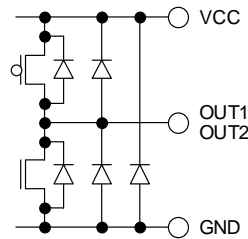

Fig.46 OUT1 / OUT2 (SOP8/HRP7)

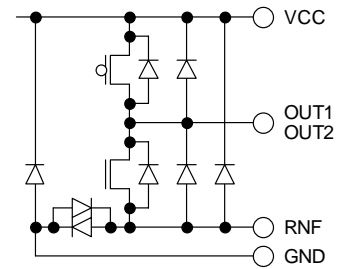

Fig.47 OUT1 / OUT2 (HSOP25/HSOPM28)



## ●Operational Notes

### 1) Absolute maximum ratings

Operating the IC over the absolute maximum ratings may damage the IC. The damage can either be a short circuit between pins or an open circuit between pins. Therefore, it is important to consider circuit protection measures, such as adding a fuse, in case the IC is operated over the absolute maximum ratings.

### 2) Reverse connection of power supply

Connecting the power supply in reverse polarity can damage the IC. Take precautions against reverse polarity when connecting the power supply, such as mounting an external diode between the power supply and the IC's power supply terminals.

### 3) Power supply lines

Design the PCB layout pattern to provide low impedance ground and supply lines. Separate the ground and supply lines of the digital and analog blocks to prevent noise in the ground and supply lines of the digital block from affecting the analog block. Furthermore, connect a capacitor to ground at all power supply pins. Consider the effect of temperature and aging on the capacitance value when using electrolytic capacitors.

### 4) Ground Voltage

The voltage of the ground pin must be the lowest voltage of all pins of the IC at all operating conditions. Ensure that no pins are at a voltage below the ground pin at any time, even during transient condition.

### 5) Thermal consideration

Use a thermal design that allows for a sufficient margin by taking into account the permissible power dissipation (Pd) in actual operating conditions. Consider Pc that does not exceed Pd in actual operating conditions ( $P_c \geq P_d$ ).

Package Power dissipation :  $P_d (W) = (T_{jmax} - T_a) / \theta_{ja}$   
 Power dissipation :  $P_c (W) = (V_{cc} - V_o) \times I_o + V_{cc} \times I_b$

(  $T_{jmax}$  : Maximum junction temperature=150°C,  $T_a$  : Peripheral temperature[°C] ,  
 $\theta_{ja}$  : Thermal resistance of package-ambience[°C/W],  $P_d$  : Package Power dissipation [W],  
 $P_c$  : Power dissipation [W],  $V_{cc}$  : Input Voltage,  $V_o$  : Output Voltage,  $I_o$  : Load,  $I_b$  : Bias Current )

### 6) Short between pins and mounting errors

Be careful when mounting the IC on printed circuit boards. The IC may be damaged if it is mounted in a wrong orientation or if pins are shorted together. Short circuit may be caused by conductive particles caught between the pins.

### 7) Operation under strong electromagnetic field

Operating the IC in the presence of a strong electromagnetic field may cause the IC to malfunction.

### 8) Area of Safe Operation (ASO)

Operate the IC such that the output voltage, output current, and power dissipation are all within the Area of Safe Operation (ASO).

### 9) Capacitor between output and GND

If a large capacitor is connected between the output pin and GND pin, current from the charged capacitor can flow into the output pin and may destroy the IC when the VCC or VIN pin is shorted to ground or pulled down to 0V. Use a capacitor smaller than 10uF between output and GND.

### 10) Testing on application boards

When testing the IC on an application board, connecting a capacitor directly to a low-impedance output pin may subject the IC to stress. Always discharge capacitors completely after each process or step. The IC's power supply should always be turned off completely before connecting or removing it from the test setup during the inspection process. To prevent damage from static discharge, ground the IC during assembly and use similar precautions during transport and storage.

### 11) Switching noise

When the operation mode is in PWM control or VREF control, PWM switching noise may affect the control input pins and cause IC malfunctions. In this case, insert a pull down resistor (10kΩ is recommended) between each control input pin and ground.

12) Regarding the input pin of the IC

This monolithic IC contains P+ isolation and P substrate layers between adjacent elements in order to keep them isolated. P-N junctions are formed at the intersection of the P layers with the N layers of other elements, creating a parasitic diode or transistor. For example (refer to figure below):

When  $GND > Pin A$  and  $GND > Pin B$ , the P-N junction operates as a parasitic diode.  
 When  $GND > Pin B$ , the P-N junction operates as a parasitic transistor.

Parasitic diodes inevitably occur in the structure of the IC. The operation of parasitic diodes can result in mutual interference among circuits, operational faults, or physical damage. Therefore, conditions that cause these diodes to operate, such as applying a voltage lower than the GND voltage to an input pin (and thus to the P substrate) should be avoided.

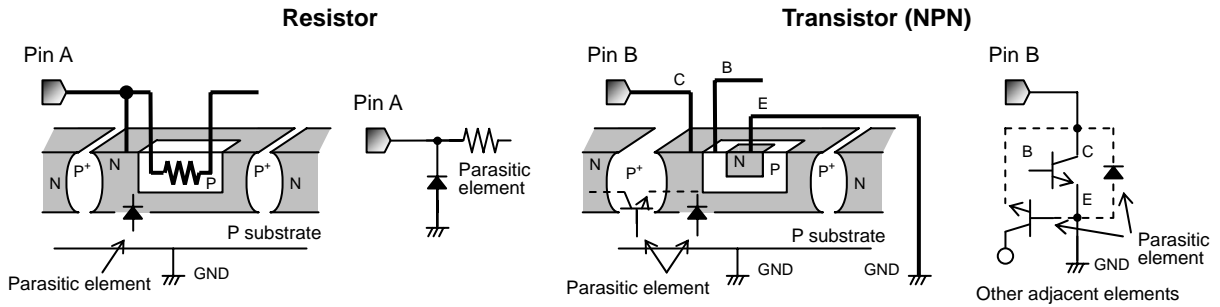
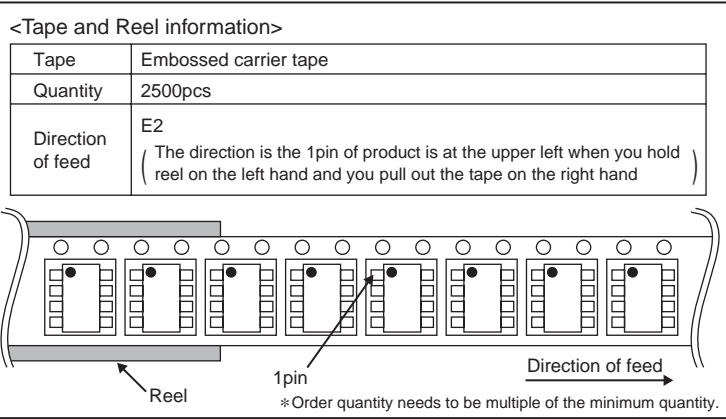
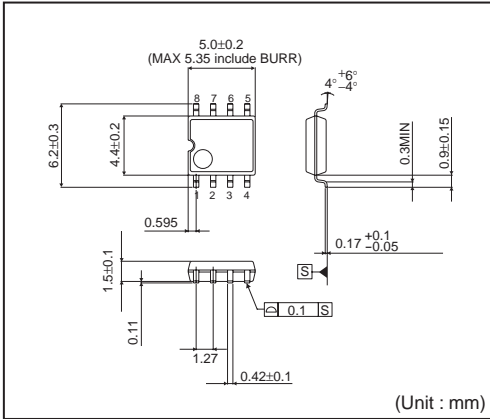

Fig. 48 Example of monolithic IC structure

●Physical Dimensions Tape and Reel Information

SOP8



HSOP25

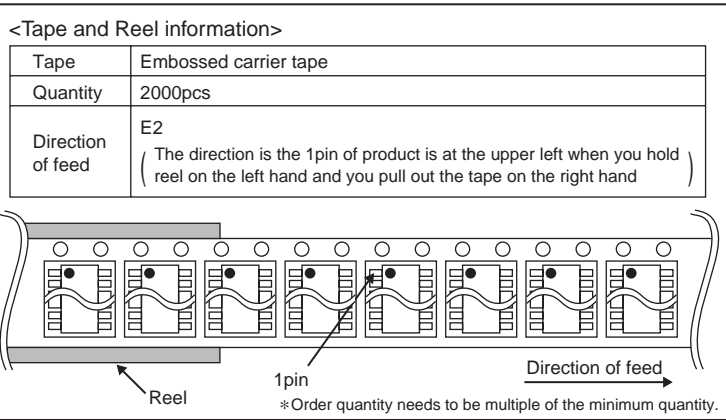
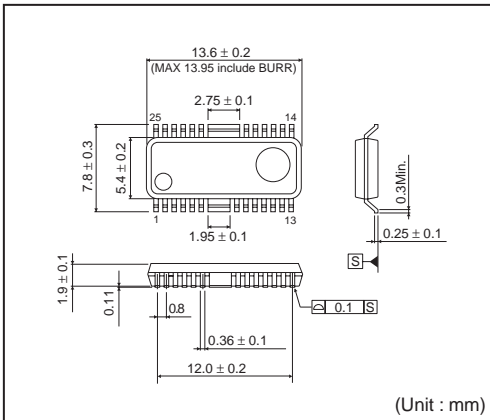

HSOP-M28

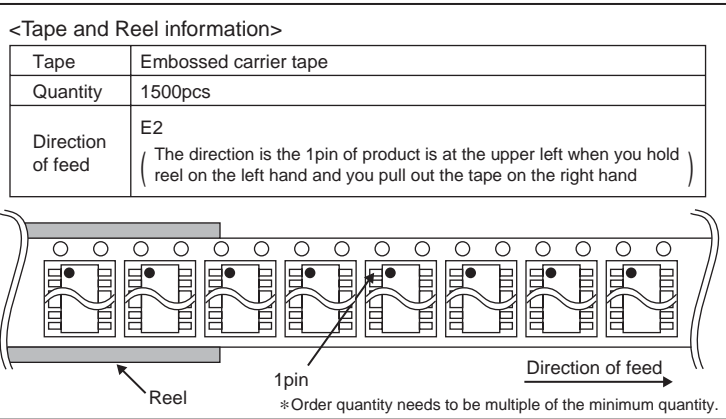
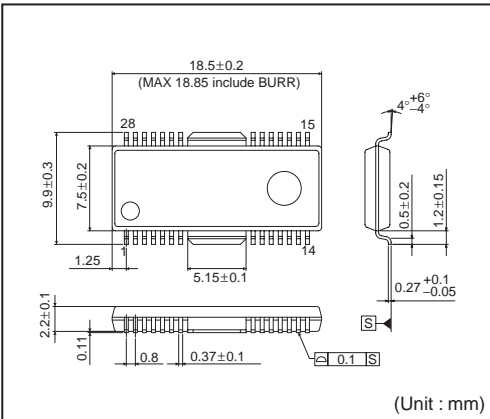

●Physical Dimensions Tape and Reel Information- Continued

HRP7

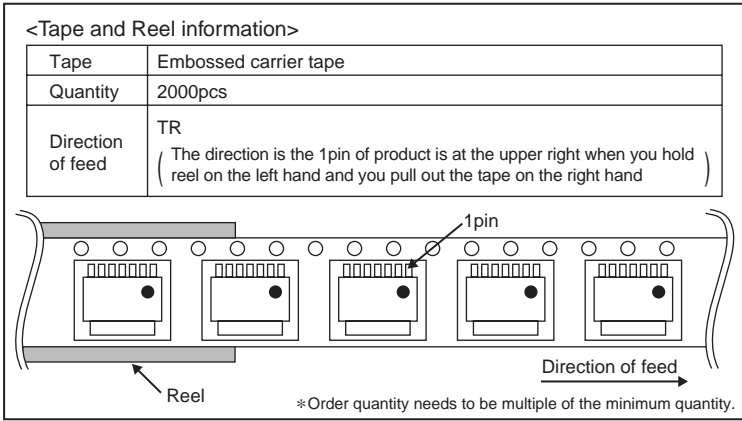
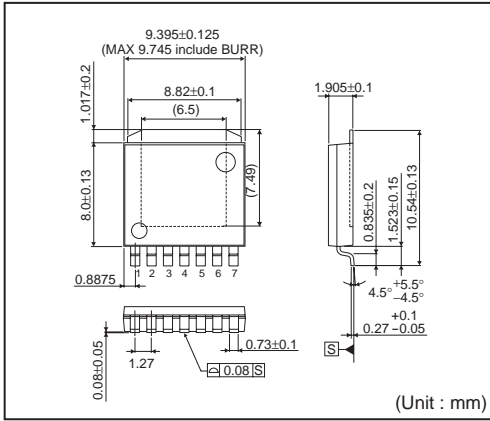

● Marking Diagrams

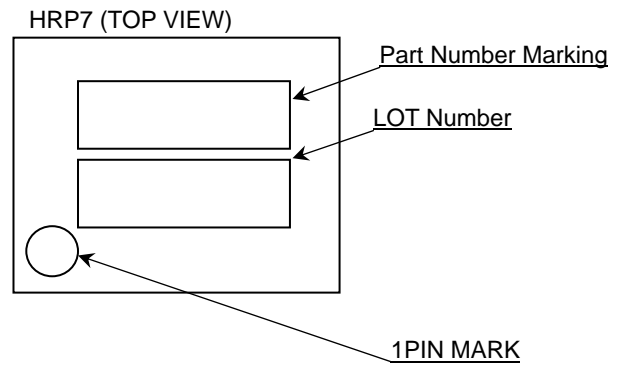
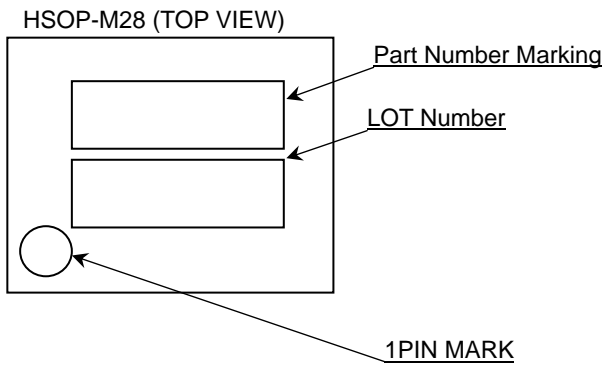
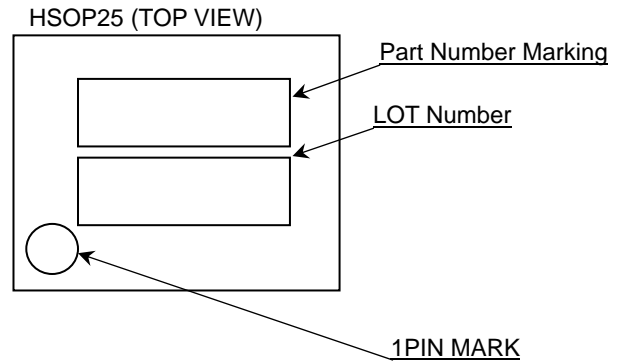
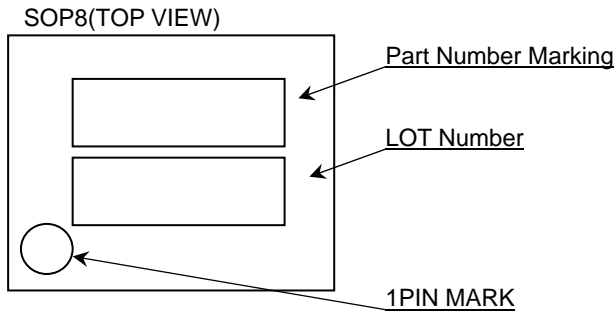

| Part Number | Package  | Part Number Marking |
|-------------|----------|---------------------|
| BD6230F     | SOP8     | 6230                |
| BD6231HFP   | HRP7     | BD6231HFP           |
| BD6231F     | SOP8     | 6231                |
| BD6232HFP   | HRP7     | BD6232HFP           |
| BD6232FP    | HSOP25   | BD6232FP            |
| BD6236FP    | HSOP25   | BD6236FP            |
| BD6236FM    | HSOP-M28 | BD6236FM            |
| BD6237FM    | HSOP/M28 | BD6237FM            |

## ●Revision History

| Date        | Revision | Changes   |
|-------------|----------|---|
| 10.Apr.2012 | 001      | New Release   |
| 25.Dec.2012 | 002      | Improved the statement in all pages.<br>Deleted "Status of this document" in page 18. |

# Notice

## Precaution on using ROHM Products

- Our Products are designed and manufactured for application in ordinary electronic equipments (such as AV equipment, OA equipment, telecommunication equipment, home electronic appliances, amusement equipment, etc.). If you intend to use our Products in devices requiring extremely high reliability (such as medical equipment <sup>(Note 1)</sup>, transport equipment, traffic equipment, aircraft/spacecraft, nuclear power controllers, fuel controllers, car equipment including car accessories, safety devices, etc.) and whose malfunction or failure may cause loss of human life, bodily injury or serious damage to property ("Specific Applications"), please consult with the ROHM sales representative in advance. Unless otherwise agreed in writing by ROHM in advance, ROHM shall not be in any way responsible or liable for any damages, expenses or losses incurred by you or third parties arising from the use of any ROHM's Products for Specific Applications.

(Note1) Medical Equipment Classification of the Specific Applications

| JAPAN     | USA       | EU         | CHINA     |
|-----------|-----------|------------|-----------|
| CLASS III | CLASS III | CLASS II b | CLASS III |
| CLASS IV  |           | CLASS III  |           |

- ROHM designs and manufactures its Products subject to strict quality control system. However, semiconductor products can fail or malfunction at a certain rate. Please be sure to implement, at your own responsibilities, adequate safety measures including but not limited to fail-safe design against the physical injury, damage to any property, which a failure or malfunction of our Products may cause. The following are examples of safety measures:
  - Installation of protection circuits or other protective devices to improve system safety
  - Installation of redundant circuits to reduce the impact of single or multiple circuit failure
- Our Products are designed and manufactured for use under standard conditions and not under any special or extraordinary environments or conditions, as exemplified below. Accordingly, ROHM shall not be in any way responsible or liable for any damages, expenses or losses arising from the use of any ROHM's Products under any special or extraordinary environments or conditions. If you intend to use our Products under any special or extraordinary environments or conditions (as exemplified below), your independent verification and confirmation of product performance, reliability, etc. prior to use, must be necessary:
  - Use of our Products in any types of liquid, including water, oils, chemicals, and organic solvents
  - Use of our Products outdoors or in places where the Products are exposed to direct sunlight or dust
  - Use of our Products in places where the Products are exposed to sea wind or corrosive gases, including Cl<sub>2</sub>, H<sub>2</sub>S, NH<sub>3</sub>, SO<sub>2</sub>, and NO<sub>2</sub>
  - Use of our Products in places where the Products are exposed to static electricity or electromagnetic waves
  - Use of our Products in proximity to heat-producing components, plastic cords, or other flammable items
  - Sealing or coating our Products with resin or other coating materials
  - Use of our Products without cleaning residue of flux (even if you use no-clean type fluxes, cleaning residue of flux is recommended); or Washing our Products by using water or water-soluble cleaning agents for cleaning residue after soldering
  - Use of the Products in places subject to dew condensation
- The Products are not subject to radiation-proof design.
- Please verify and confirm characteristics of the final or mounted products in using the Products.
- In particular, if a transient load (a large amount of load applied in a short period of time, such as pulse. is applied, confirmation of performance characteristics after on-board mounting is strongly recommended. Avoid applying power exceeding normal rated power; exceeding the power rating under steady-state loading condition may negatively affect product performance and reliability.
- De-rate Power Dissipation (Pd) depending on Ambient temperature (Ta). When used in sealed area, confirm the actual ambient temperature.
- Confirm that operation temperature is within the specified range described in the product specification.
- ROHM shall not be in any way responsible or liable for failure induced under deviant condition from what is defined in this document.

## Precaution for Mounting / Circuit board design

- When a highly active halogenous (chlorine, bromine, etc.) flux is used, the residue of flux may negatively affect product performance and reliability.
- In principle, the reflow soldering method must be used; if flow soldering method is preferred, please consult with the ROHM representative in advance.

For details, please refer to ROHM Mounting specification

**Precautions Regarding Application Examples and External Circuits**

1. If change is made to the constant of an external circuit, please allow a sufficient margin considering variations of the characteristics of the Products and external components, including transient characteristics, as well as static characteristics.
2. You agree that application notes, reference designs, and associated data and information contained in this document are presented only as guidance for Products use. Therefore, in case you use such information, you are solely responsible for it and you must exercise your own independent verification and judgment in the use of such information contained in this document. ROHM shall not be in any way responsible or liable for any damages, expenses or losses incurred by you or third parties arising from the use of such information.

**Precaution for Electrostatic**

This Product is electrostatic sensitive product, which may be damaged due to electrostatic discharge. Please take proper caution in your manufacturing process and storage so that voltage exceeding the Products maximum rating will not be applied to Products. Please take special care under dry condition (e.g. Grounding of human body / equipment / solder iron, isolation from charged objects, setting of Ionizer, friction prevention and temperature / humidity control).

**Precaution for Storage / Transportation**

1. Product performance and soldered connections may deteriorate if the Products are stored in the places where:
  - [a] the Products are exposed to sea winds or corrosive gases, including Cl<sub>2</sub>, H<sub>2</sub>S, NH<sub>3</sub>, SO<sub>2</sub>, and NO<sub>2</sub>
  - [b] the temperature or humidity exceeds those recommended by ROHM
  - [c] the Products are exposed to direct sunshine or condensation
  - [d] the Products are exposed to high Electrostatic
2. Even under ROHM recommended storage condition, solderability of products out of recommended storage time period may be degraded. It is strongly recommended to confirm solderability before using Products of which storage time is exceeding the recommended storage time period.
3. Store / transport cartons in the correct direction, which is indicated on a carton with a symbol. Otherwise bent leads may occur due to excessive stress applied when dropping of a carton.
4. Use Products within the specified time after opening a humidity barrier bag. Baking is required before using Products of which storage time is exceeding the recommended storage time period.

**Precaution for Product Label**

QR code printed on ROHM Products label is for ROHM's internal use only.

**Precaution for Disposition**

When disposing Products please dispose them properly using an authorized industry waste company.

**Precaution for Foreign Exchange and Foreign Trade act**

Since our Products might fall under controlled goods prescribed by the applicable foreign exchange and foreign trade act, please consult with ROHM representative in case of export.

**Precaution Regarding Intellectual Property Rights**

1. All information and data including but not limited to application example contained in this document is for reference only. ROHM does not warrant that foregoing information or data will not infringe any intellectual property rights or any other rights of any third party regarding such information or data. ROHM shall not be in any way responsible or liable for infringement of any intellectual property rights or other damages arising from use of such information or data.:
2. No license, expressly or implied, is granted hereby under any intellectual property rights or other rights of ROHM or any third parties with respect to the information contained in this document.

**Other Precaution**

1. This document may not be reprinted or reproduced, in whole or in part, without prior written consent of ROHM.
2. The Products may not be disassembled, converted, modified, reproduced or otherwise changed without prior written consent of ROHM.
3. In no event shall you use in any way whatsoever the Products and the related technical information contained in the Products or this document for any military purposes, including but not limited to, the development of mass-destruction weapons.
4. The proper names of companies or products described in this document are trademarks or registered trademarks of ROHM, its affiliated companies or third parties.



**General Precaution**

1. Before you use our Products, you are requested to carefully read this document and fully understand its contents. ROHM shall not be in any way responsible or liable for failure, malfunction or accident arising from the use of any ROHM's Products against warning, caution or note contained in this document.
2. All information contained in this document is current as of the issuing date and subject to change without any prior notice. Before purchasing or using ROHM's Products, please confirm the latest information with a ROHM sales representative.
3. The information contained in this document is provided on an "as is" basis and ROHM does not warrant that all information contained in this document is accurate and/or error-free. ROHM shall not be in any way responsible or liable for any damages, expenses or losses incurred by you or third parties resulting from inaccuracy or errors of or concerning such information.

# Mouser Electronics

Authorized Distributor

Click to View Pricing, Inventory, Delivery & Lifecycle Information:

[ROHM Semiconductor:](#)

[BD6230HFP-TR](#)

## Данный компонент на территории Российской Федерации

### Вы можете приобрести в компании MosChip.

Для оперативного оформления запроса Вам необходимо перейти по данной ссылке:

<http://moschip.ru/get-element>

Вы можете разместить у нас заказ для любого Вашего проекта, будь то серийное производство или разработка единичного прибора.

В нашем ассортименте представлены ведущие мировые производители активных и пассивных электронных компонентов.

Нашей специализацией является поставка электронной компонентной базы двойного назначения, продукции таких производителей как XILINX, Intel (ex.ALTERA), Vicor, Microchip, Texas Instruments, Analog Devices, Mini-Circuits, Amphenol, Glenair.

Сотрудничество с глобальными дистрибьюторами электронных компонентов, предоставляет возможность заказывать и получать с международных складов практически любой перечень компонентов в оптимальные для Вас сроки.

На всех этапах разработки и производства наши партнеры могут получить квалифицированную поддержку опытных инженеров.

Система менеджмента качества компании отвечает требованиям в соответствии с ГОСТ Р ИСО 9001, ГОСТ РВ 0015-002 и ЭС РД 009

### Офис по работе с юридическими лицами:

105318, г.Москва, ул.Щербаковская д.3, офис 1107, 1118, ДЦ «Щербаковский»

Телефон: +7 495 668-12-70 (многоканальный)

Факс: +7 495 668-12-70 (доб.304)

E-mail: [info@moschip.ru](mailto:info@moschip.ru)

Skype отдела продаж:

moschip.ru

moschip.ru\_4

moschip.ru\_6

moschip.ru\_9