

## D-sub Connectors

XM3-L/XM2-L/  
XM4K/XM4L

### The D-sub Connector Series Enters a New Era with Lead-free Products.

- Determine anchor screw diameters at a glance.
- Greatly simplified anchor combinations.
- Shielded against EMI.
- The XM3-L/XM2-L/XM4K/XM4L conform to UL standards (No. E103202) (Some models are not included)

**RoHS Compliant**



\* Some models are not included.

### ■ Connectors

Classification	D-sub Connectors			
Model	XM3B-L	XM2C-L	XM2E-L	XM2F-L
Type	Sockets with Right-angle DIP Terminals	Plugs with Right-angle DIP Terminals	Plugs with Straight DIP Terminals	Sockets with Straight DIP Terminals
Appearance				

Classification	High-density D-sub Connectors		
Model	XM4K	XM4L	XM4L
Type	Plugs with Right-angle DIP Terminals	Sockets with Right-angle DIP Terminals	Sockets with Straight DIP Terminals
Appearance			

### ■ Ratings and Characteristics

Rated current	3 A
Rated voltage	300 VAC
Contact resistance	20 mΩ max. (at 20 mV, 100 mA max.)
Insulation resistance	1,000 MΩ min. (at 500 VDC)
Dielectric strength	1,000 VAC for 1 min (leakage current: 1 mA max.)
Insertion durability	100 times
Ambient operating temperature	- 25 to 105°C (with no condensation or icing)

### ■ Materials and Finish

Housing		PBT (UL94 V-0)/black
Contact	Socket	Mating end Terminal Phosphor bronze/nickel base, flash gold plated
	Plug	Mating end Terminal Brass/Nickel base, flash gold plated
Shell		Steel
Anchors		Steel
Grounding Fixture	Straight	Brass/Tin plated
	Right angle	Brass/Nickel plated

# XM3-L/XM2-L/XM4K/XM4L D-sub Connectors

## ■ Ordering Information

### D-sub Sockets with Right-angle DIP Terminals

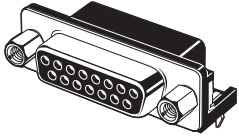
<b>Appearance</b>			
<b>Accessories</b>	<b>No anchors</b>	<b>Anchor 2 (XM4Z-0011) M2.6 × 0.45</b>	<b>Anchor 2 (XM4Z-0013) #4-40 UNC</b>
<b>No. of contacts</b>			
9	XM3B-0942-502L	XM3B-0942-112L	XM3B-0942-132L
15	XM3B-1542-502L	XM3B-1542-112L	XM3B-1542-132L
25	XM3B-2542-502L	XM3B-2542-112L	XM3B-2542-132L

### D-sub Plugs with Right-angle DIP Terminals

<b>Appearance</b>			
<b>Accessories</b>	<b>No anchors</b>	<b>Anchor 2 (XM4Z-0011) M2.6 × 0.45</b>	<b>Anchor 2 (XM4Z-0013) #4-40 UNC</b>
<b>No. of contacts</b>			
9	XM2C-0942-502L	XM2C-0942-112L	XM2C-0942-132L
15	XM2C-1542-502L	XM2C-1542-112L	XM2C-1542-132L
25	XM2C-2542-502L	XM2C-2542-112L	XM2C-2542-132L

### D-sub Plugs with Straight DIP Terminals

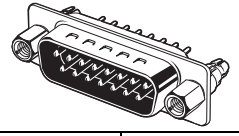
<b>Appearance</b>				
<b>Accessories</b>	<b>No anchors Without ground pins</b>	<b>No anchors</b>	<b>Anchor 2 (XM4Z-1011) M2.6 × 0.45</b>	<b>Anchor 2 (XM4Z-1013) #4- 40 UNC</b>
<b>No. of contacts</b>				
9	XM2E-0940-L	XM2E-0940-502L	XM2E-0940-112L	XM2E-0940-132L
15	XM2E-1540-L	XM2E-1540-502L	XM2E-1540-112L	XM2E-1540-132L
25	XM2E-2540-L	XM2E-2540-502L	XM2E-2540-112L	XM2E-2540-132L

### D-sub Sockets with Straight DIP Terminals

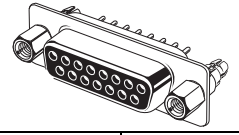
<b>Appearance</b>				
<b>Accessories</b>	<b>No anchors Without ground pins</b>	<b>No anchors</b>	<b>Anchor 2 (XM4Z-1011) M2.6 × 0.45</b>	<b>Anchor 2 (XM4Z-1013) #4- 40 UNC</b>
<b>No. of contacts</b>				
9	XM2F-0940-L	XM2F-0940-502L	XM2F-0940-112L	XM2F-0940-132L
15	XM2F-1540-L	XM2F-1540-502L	XM2F-1540-112L	XM2F-1540-132L
25	XM2F-2540-L	XM2F-2540-502L	XM2F-2540-112L	XM2F-2540-132L

**Note:** For other models with Anchors, contact your OMRON representative.

**High-density D-sub Plugs with Right-angle DIP Terminals**

Appearance			
Accessories	No anchors	Anchor 2 (XM4Z-0011) M2.6 × 0.45	Anchor 2 (XM4Z-0013) #4-40 UNC
No. of contacts			
15	XM4K-1542-502	XM4K-1542-112	XM4K-1542-132

**High-density D-sub Sockets with Right-angle DIP Terminals**

Appearance			
Accessories	No anchors	Anchor 2 (XM4Z-0011) M2.6 × 0.45	Anchor 2 (XM4Z-0013) #4-40 UNC
No. of contacts			
15	XM4L-1542-502	XM4L-1542-112	XM4L-1542-132

**High-density D-sub Sockets with Straight DIP Terminals**





Appearance			
Accessories	No anchors	Anchor 2 (XM4Z-1011) M2.6 × 0.45	Anchor 2 (XM4Z-1013) #4-40 UNC
No. of contacts			
15	XM4L-1541-502	XM4L-1541-112	XM4L-1541-132

Note: For other models with Anchors, contact your OMRON representative.

**Anchor 2 (Screw Head Length: 5.8 mm)**

Type	For right-angle DIP terminals			For straight DIP terminals		
Appearance						
Lock screw	M2.6 × 0.45	M3 × 0.5	#4-40 UNC	M2.6 × 0.45	M3 × 0.5	#4-40 UNC
Model	XM4Z-0011	XM4Z-0012	XM4Z-0013	XM4Z-1011	XM4Z-1012	XM4Z-1013

**Anchor 3 (Screw Head Length: 4.8 mm)**

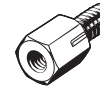
Type	For right-angle DIP terminals			For straight DIP terminals		
Appearance						
Lock screw	M2.6 × 0.45	M3 × 0.5	#4-40 UNC	M2.6 × 0.45	M3 × 0.5	#4-40 UNC
Model	XM4Z-0021	XM4Z-0022	XM4Z-0023	XM4Z-1021	XM4Z-1022	XM4Z-1023

■ Dimensions

(unit: mm)

**D-sub Sockets with Right-angle DIP Terminals**

XM3B-0942-132L  
 XM3B-1542-132L  
 XM3B-2542-132L

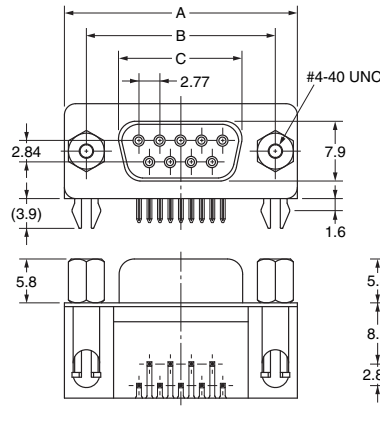
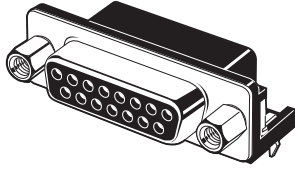

Mounting holes (t = 1.6 mm, bottom view)



Dimensions

No. of contacts (N)	A	B	C	D
9	30.8	24.99	16.33	6.96
15	39.1	33.32	24.66	6.96
25	53.0	47.04	38.38	6.91

**D-sub Plugs with Right-angle DIP Terminals**

XM2C-0942-132L  
 XM2C-1542-132L  
 XM2C-2542-132L

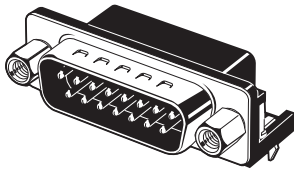

Mounting holes (t = 1.6 mm, bottom view)



Dimensions

No. of contacts (N)	A	B	C	D
9	30.8	24.99	16.92	6.96
15	39.1	33.32	25.25	6.96
25	53.0	47.04	38.96	6.91

**D-sub Plugs with Straight DIP Terminals**

XM2E-0940-132L  
 XM2E-1540-132L  
 XM2E-2540-132L

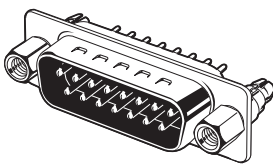

Mounting holes (t = 1.6 mm, bottom view)



Dimensions

No. of contacts (N)	A	B	C	D	E
9	30.8	24.99	16.92	19.23	6.96
15	39.1	33.32	25.25	27.56	6.96
25	53.0	47.04	38.96	41.28	6.91

### D-sub Sockets with Straight DIP Terminals

(unit: mm)

XM2F-0940-132L  
 XM2F-1540-132L  
 XM2F-2540-132L



Mounting holes (t = 1.6 mm, bottom view)



Dimensions

No. of contacts (N)	A	B	C	D	E
9	30.8	24.99	16.33	19.23	6.96
15	39.1	33.32	24.66	27.56	6.96
25	53.0	47.04	38.38	41.28	6.91

### High-density D-sub Plugs with Right-angle DIP Terminals

XM4K-1542-132



Mounting holes (t = 1.6 mm, bottom view)



### High-density D-sub Sockets with Right-angle DIP Terminals

XM4L-1542-132



Mounting holes (t = 1.6 mm, bottom view)



# High-density D-sub Sockets with Straight DIP Terminals

(unit: mm)

XM4L-1541-132



## Anchor 2



## Anchor 3



## Dimensions: Not Panel Mounted (Using Anchor 2)



Dimensions

No. of contacts (N)	A
9 (See note.)	31.0
15	39.4
25	53.3

- Note:** 1. Two Anchors are required per Connector.  
 2. Applicable panel thickness is less than 1.2 mm.

**Note:** The XM4K and XM4L use 9-contact dimensions.

## Dimensions: Panel Mounted (Using Anchor 3 or M3 Screws)

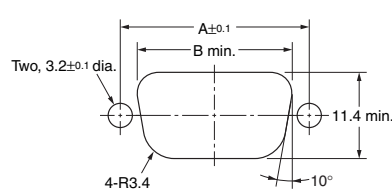

Dimensions

No. of contacts (N)	A	B
9 (See note.)	24.99	20.5
15	33.32	28.8
25	47.04	42.5

- Note:** 1. Two Anchors are required per Connector.  
 2. Applicable panel thickness is less than 1.2 mm.

**Note:** The XM4K and XM4L use 9-contact dimensions.

**Note:** 2 anchors are necessary per connector.

**Combination of hexagonal anchors for each connector (in post installation)**

Type	Model	Without panel insertion	With panel insertion	Commercially available nut
DIP Right-angle socket	XM4L-1542-502	XM4Z-001□	XM4Z-002□	Not necessary
	XM3B-□□42-502L			
DIP Right-angle plug	XM4K-1542-502	XM4Z-001□	XM4Z-002□	Not necessary
	XM2C-□□42-502L			
DIP straight socket	XM4L-1541-502	XM4Z-101□	XM4Z-102□	Not necessary
	XM2F-□□40-L			Necessary
	XM2F-□□40-502L			Not necessary
DIP straight plug	XM2E-□□40-L	XM4Z-101□	XM4Z-102□	Necessary
	XM2E-□□40-502L			Not necessary

## ■ Precautions

### Correct Use

#### ● Grounding (Lock Pin Grounding Fixture)

- To ground, provide copper foil around the Connector Attachment hole on the board, assemble the connector and grounding fixture, and dip in solder as shown below.
- Insert the connector into the PCB and then simultaneously dip-solder the connector terminals and lock pin to the board.



#### ● Soldering

##### Automated Soldering Conditions (Jet Flow)

1. Soldering temperature:  $250 \pm 5^\circ\text{C}$
2. Continuous soldering time: Within  $5 \pm 1$  s

#### ● Tightening Torque of Anchor and Grounding Fixture

If the anchor is secured to the connector, be sure to tighten it to a torque of 0.49 N·m.

Also, use a proper size tool to do this work.

#### ● Mating

Do not connect the Connectors in the wrong direction, otherwise it may be damaged.

• Application examples provided in this document are for reference only. In actual applications, confirm equipment functions and safety before using the product.  
 • Consult your OMRON representative before using the product under conditions which are not described in the manual or applying the product to nuclear control systems, railroad systems, aviation systems, vehicles, combustion systems, medical equipment, amusement machines, safety equipment, and other systems or equipment that may have a serious influence on lives and property if used improperly. Make sure that the ratings and performance characteristics of the product provide a margin of safety for the system or equipment, and be sure to provide the system or equipment with double safety mechanisms.

**Note: Do not use this document to operate the Unit.**

**OMRON Corporation**

Electronic and Mechanical Components Company

Contact: [www.omron.com/ecb](http://www.omron.com/ecb)

Cat. No. G060-E1-02  
1014(0412)(O)



## Данный компонент на территории Российской Федерации

### Вы можете приобрести в компании MosChip.

Для оперативного оформления запроса Вам необходимо перейти по данной ссылке:

<http://moschip.ru/get-element>

Вы можете разместить у нас заказ для любого Вашего проекта, будь то серийное производство или разработка единичного прибора.

В нашем ассортименте представлены ведущие мировые производители активных и пассивных электронных компонентов.

Нашей специализацией является поставка электронной компонентной базы двойного назначения, продукции таких производителей как XILINX, Intel (ex.ALTERA), Vicor, Microchip, Texas Instruments, Analog Devices, Mini-Circuits, Amphenol, Glenair.

Сотрудничество с глобальными дистрибьюторами электронных компонентов, предоставляет возможность заказывать и получать с международных складов практически любой перечень компонентов в оптимальные для Вас сроки.

На всех этапах разработки и производства наши партнеры могут получить квалифицированную поддержку опытных инженеров.

Система менеджмента качества компании отвечает требованиям в соответствии с ГОСТ Р ИСО 9001, ГОСТ РВ 0015-002 и ЭС РД 009

### Офис по работе с юридическими лицами:

105318, г.Москва, ул.Щербаковская д.3, офис 1107, 1118, ДЦ «Щербаковский»

Телефон: +7 495 668-12-70 (многоканальный)

Факс: +7 495 668-12-70 (доб.304)

E-mail: [info@moschip.ru](mailto:info@moschip.ru)

Skype отдела продаж:

moschip.ru

moschip.ru\_4

moschip.ru\_6

moschip.ru\_9