

## ACT510xEVK1-102 User's Guide

### Description

This document describes the characteristic and operation of the Active Semi ACT5101EVK1-102 and ACT5102EVK1-102 evaluation kits (EVK). It provides setup and operation instructions, schematic, layout, BOM, and test data. The ACT5101EVK1-102 demonstrates the ACT5101Q102 power management IC. The ACT5102EVK1-102 demonstrates the ACT5102Q102 power management IC. Other ACT5101Q1xxx and ACT5102Q1xxx options can be evaluated on these EVKs by replacing the IC and any other necessary components.

The two EVKs are very similar. The difference is that the ACT5101 output voltage is set by internal registers and it has A/D functionality. The ACT5102 output voltage is set by external resistors and it does not have A/D functionality. The setup and operation of the two EVKs are identical, so this document only references the ACT5101.

### Features

The EVKs can be used as standalone boards if desired. However, to access the internal registers and to take full advantage of the IC's capability, the user must connect the EVK kits to a PC with Active Semi's USB-TO-I2C interface dongle and use the GUI software. The EVK provides full access to the each converter's input and output voltage, as well as all the digital control signals. This gives the user the flexibility to configure the EVK to match their real world system.



Figure 1 – EVK Picture

## EVK Contents

The ACT5101EVK1-102 and ACT5102EVK1-102 evaluation kits come with the following items:

1. EVK assembly
2. USB-TO-I2C dongle
  - a. Dongle
  - b. Custom 4-pin connector that connects the USB-TO-I2C dongle to the EVK assembly

## Required Equipment

ACT5101EVK1-102

USB-TO-I2C Dongle

Power supply → 4~22V @ 6A for full power operation

Oscilloscope → 100MHz, 4 channels

Digital Multi-meters (DMM)

Windows compatible PC with spare USB port.

## Hardware Setup

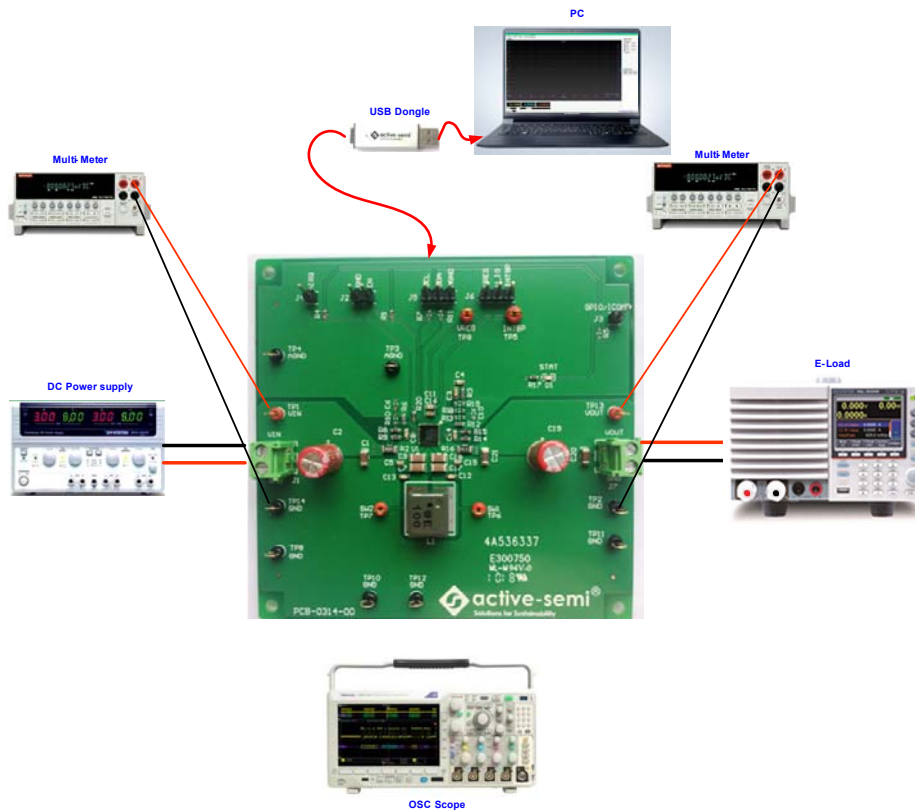

Figure 2 – EVK Setup

## Quick Start

### Hardware Connections

Refer to Figure 2 for hardware connections.

1. Connect a DC power supply to J1. Please ensure the correct power supply polarity.
2. Connect an E-Load to J7.
3. Connect Digital Multi-Meters to VIN and VOUT to monitor the input voltage and output voltages.
4. Add a digital Multi-Meter in series with VIN and VOUT if you want to observe input and output current.
5. Be careful to keep the input voltage and battery voltage within the specifications.
6. Add a jumper to J6 to connect INTBP to V\_IO.
7. Optional – Connect the EVK to the PC with the USB dongle.
8. Apply input power. Note that the out

### GUI Setup (optional)

1. Refer to the end of this document for detailed instructions to install the ACT5101 GUI.
2. Connect the USB-TO-I2C dongle to the computer via a USB cable.
3. Connect the USB-TO-I2C dongle to the EVK J5 connector. Refer to Figure 3 to ensure the correct polarity of the connection. As a guide, use the “Active-Semi” logo on the top of the dongle so the black wire is connected to the Dongle GND pin.

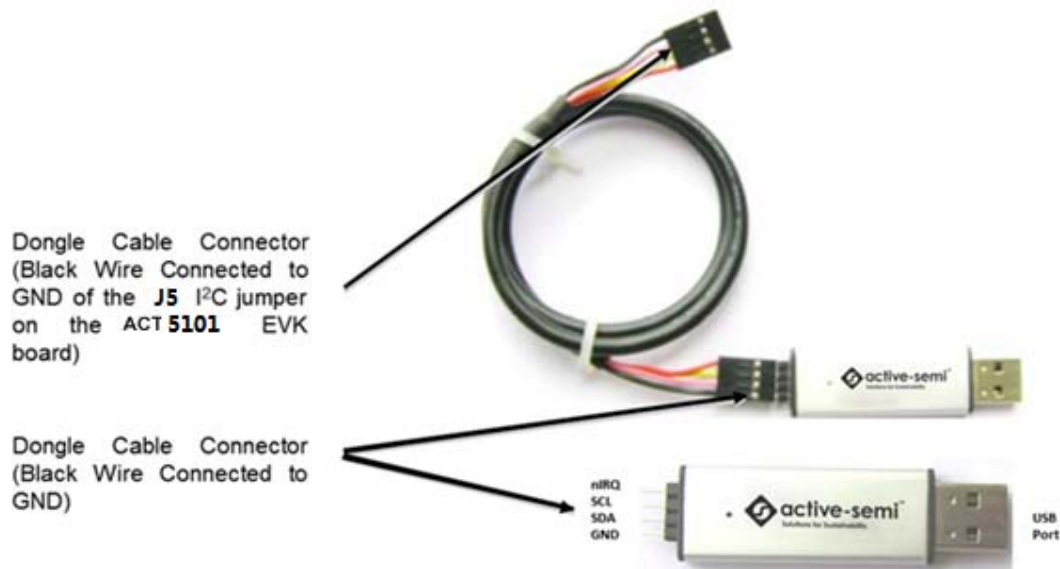

Figure 3 – USB-TO-I2C Dongle Connection

## Recommended Operating Conditions

The ACT5101EVK1-102 is designed for a 4V-22V input voltage. The maximum operating voltage is determined by the IC's maximum input voltage rating. The minimum operating voltages are determined by the buck-boost converter's minimum input voltage. Maximum currents are determined by the IC's CMI settings, which can be changed via I<sup>2</sup>C after startup. Operating currents are configured by CMI and external components.

**Table 1. Recommended Operating Conditions**

Parameter	Description	Min	Typ	Max	Unit
VIN	Charger input voltage	4	-	22	V
VOUT	Charger output voltage	3	-	20	V
I <sub>in_max</sub>	Maximum input current		5		A
I <sub>out_max</sub>	Maximum output current		5		A
I <sub>REG_max</sub>	Maximum LDO VREG load current		0.1		A

## EVK Operation

### Turn On the Evaluation Board

Before applying the input voltage, please make sure the jumper (J6) is installed. Connect V\_IO to INTBP or VREG. INTBP is the typical connection.



**Figure 4 – Hardware Configuration**

After the power source and E-Load are connected to the evaluation board per the required connections, the EVK can be powered for operation. Perform the following steps to turn on the board.

1. Ensure that the power supply connected to VIN (J1) is >4V and <22V.
3. Turn on power supply.
4. Apply the load.

### Input Current Limit Configuration

The ACT5101's ActivePath charger features configurable input and output current limit. These features are programmed with a combination of an external resistor and an internal I<sup>2</sup>C register. Refer to the ACT5101 datasheet for programming details.

**Input Current Limit** – The ACT5101EVK1-102 EVK input current limit is set to 11.11A. This is a function of the 5mΩ current sense resistor, R2, the 36kΩ RILIM resistor, R6, and the I<sup>2</sup>C Input Current Limit bits, INLIMIT, which are set to 200% by default. The hardware current limit set by R2 and R6 is 5.56A. This current multiplied by the input current limit scaling factor of 200% gives a 11.11A input current limit. The input current limit is easily changed by modifying any of these three parameters. The easiest way to change the input current limit is with the Input Current Limit field in the GUI.

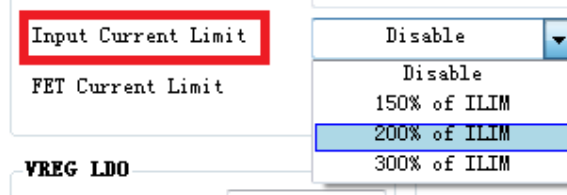

**Output Current Limit** – The ACT5101EVK1-102 EVK output current limit is set to 5A. This is a function of the 10mΩ current sense resistor, R16, the 20kΩ RILIM resistor, R12, and the I<sup>2</sup>C Input Current Limit bits, CC, which are set to 100% by default. The hardware current limit set by R16 and R12 is 5A. This current multiplied by the input current limit scaling factor of 100% gives a 5A output current limit. The output current limit is easily changed by modifying any of these three parameters. The easiest way to change the output current limit is with the Output Constant Current field in the GUI.

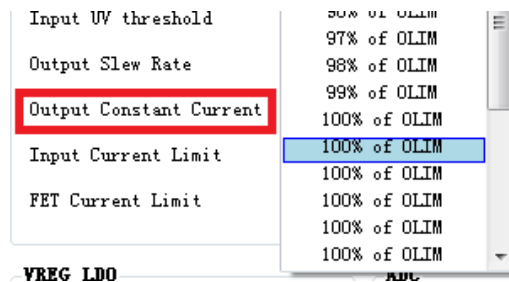

### Output Voltage Setting

ACT5101 5.1V default output voltage can be changed I<sup>2</sup>C using the Output Voltage field GUI setting.

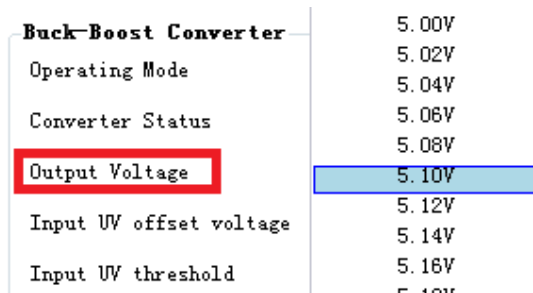

### Additional Programmable Functionality

The ACT5101 contains many additional programmable parameters. Refer to the ACT5101 datasheet for additional functionality and default I<sup>2</sup>C register values.

**Test Results**

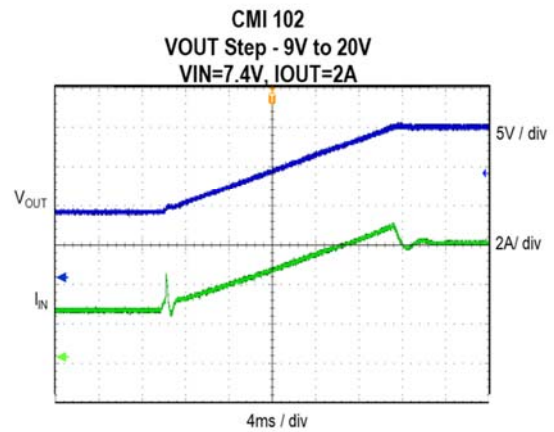
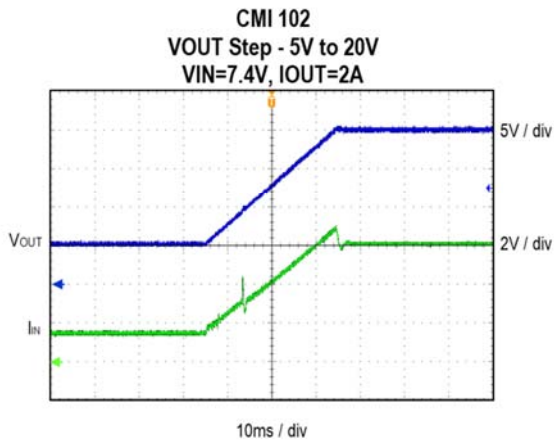
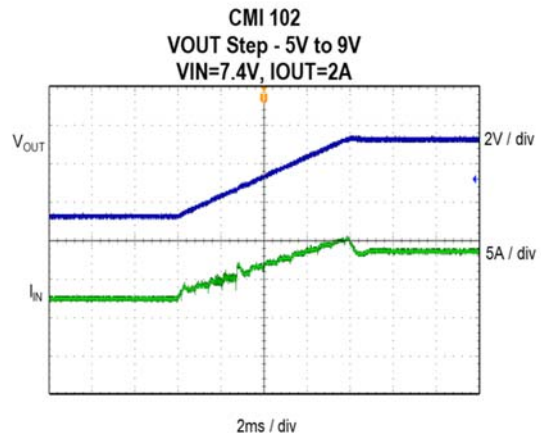
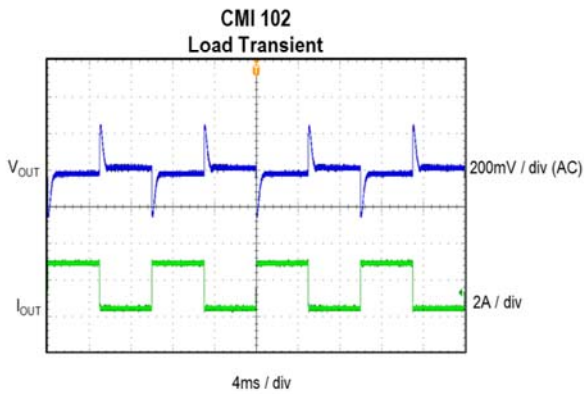
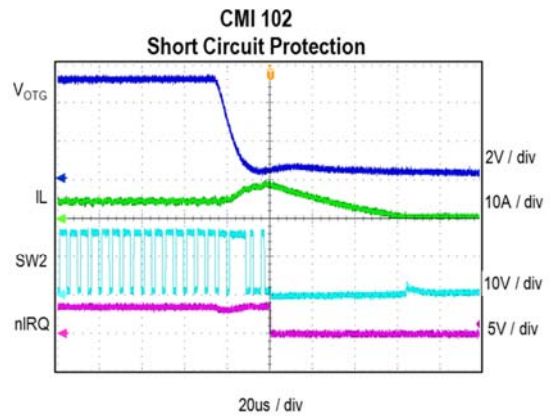
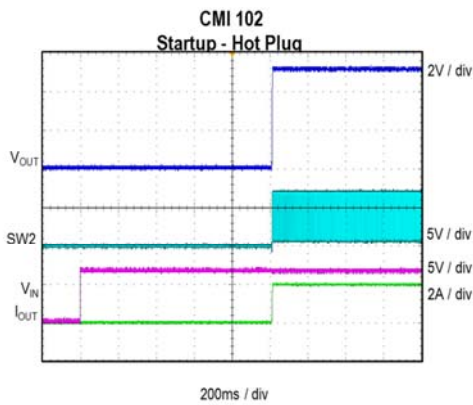

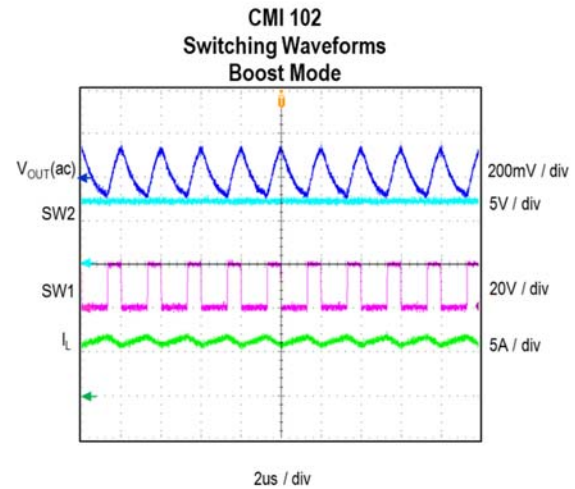
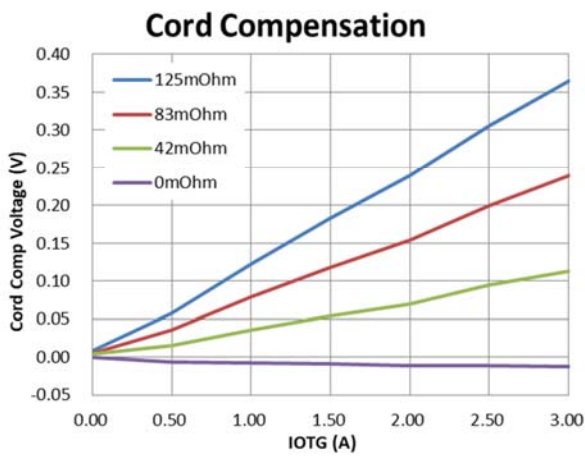
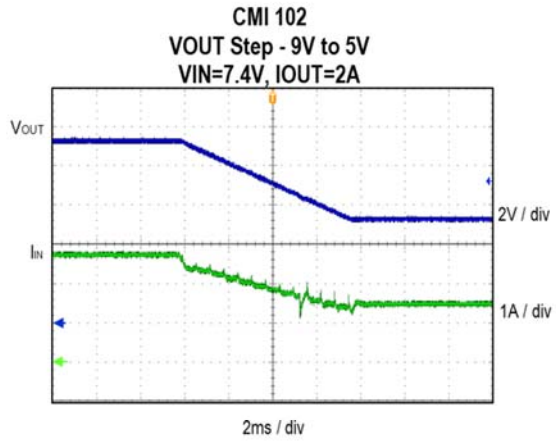
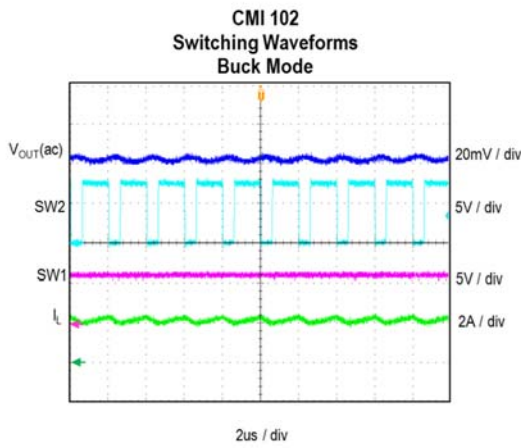
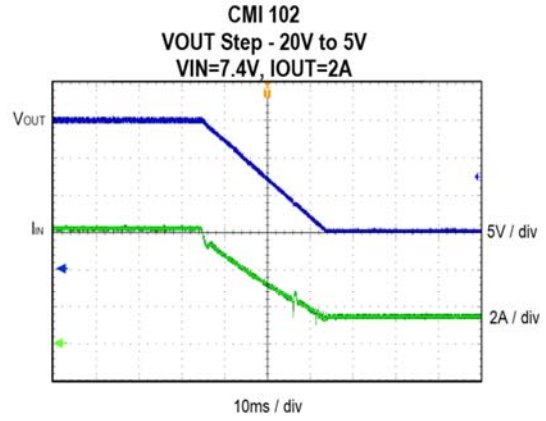
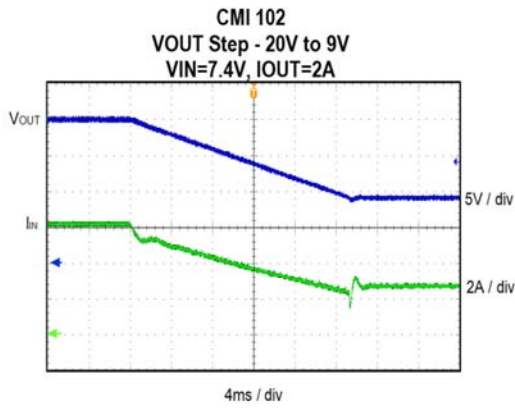

**CMI 102**  
**Switching Waveforms**  
**Buck-Boost Mode**

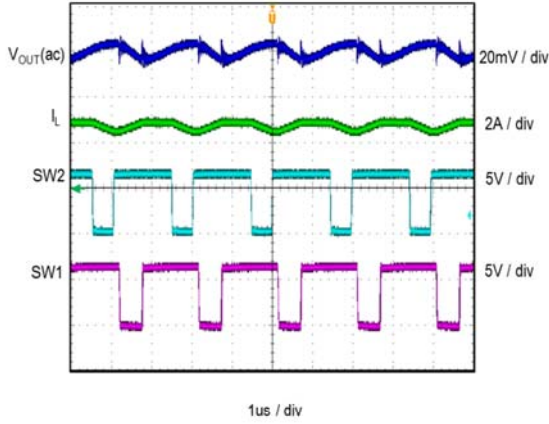

**Efficiency OTG**  
**VOTG = 12V**

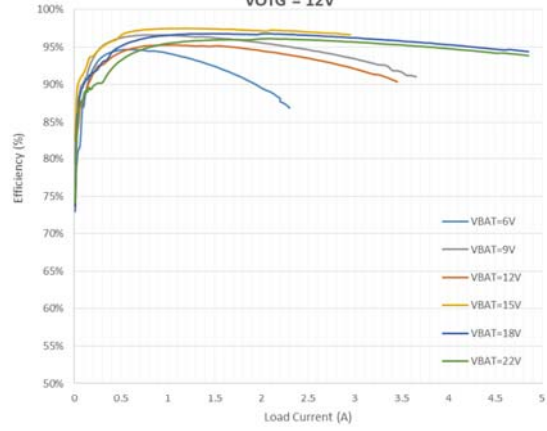

**Efficiency OTG**  
**VOTG = 5.1V**

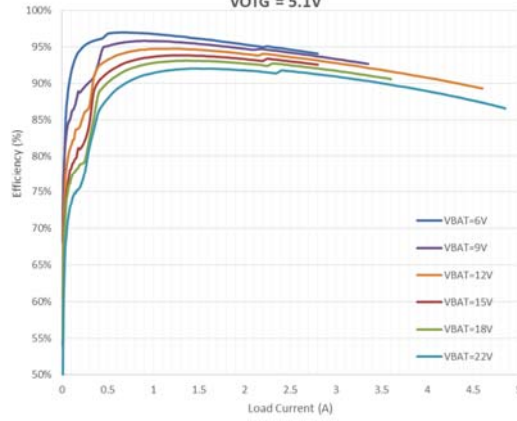



## Schematic

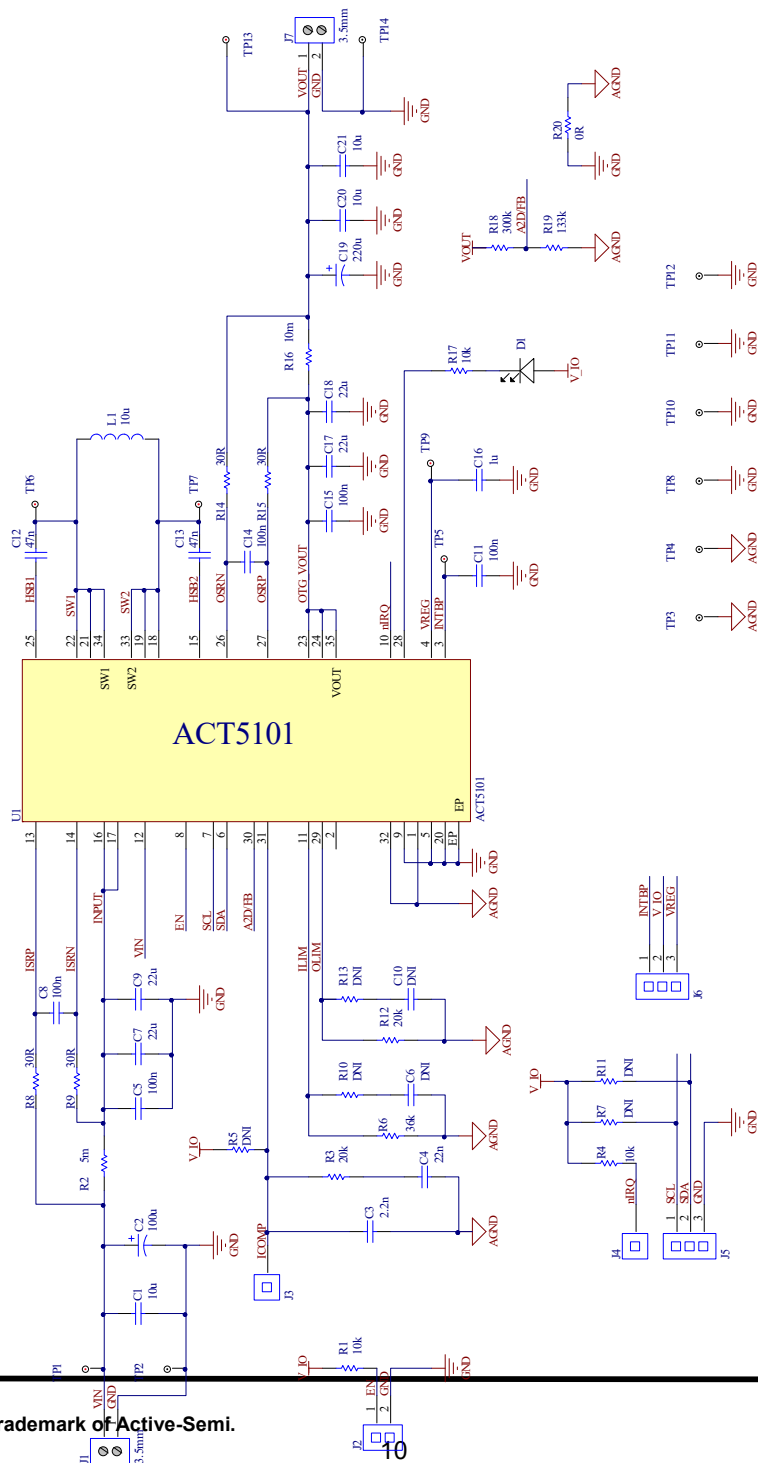

Layout

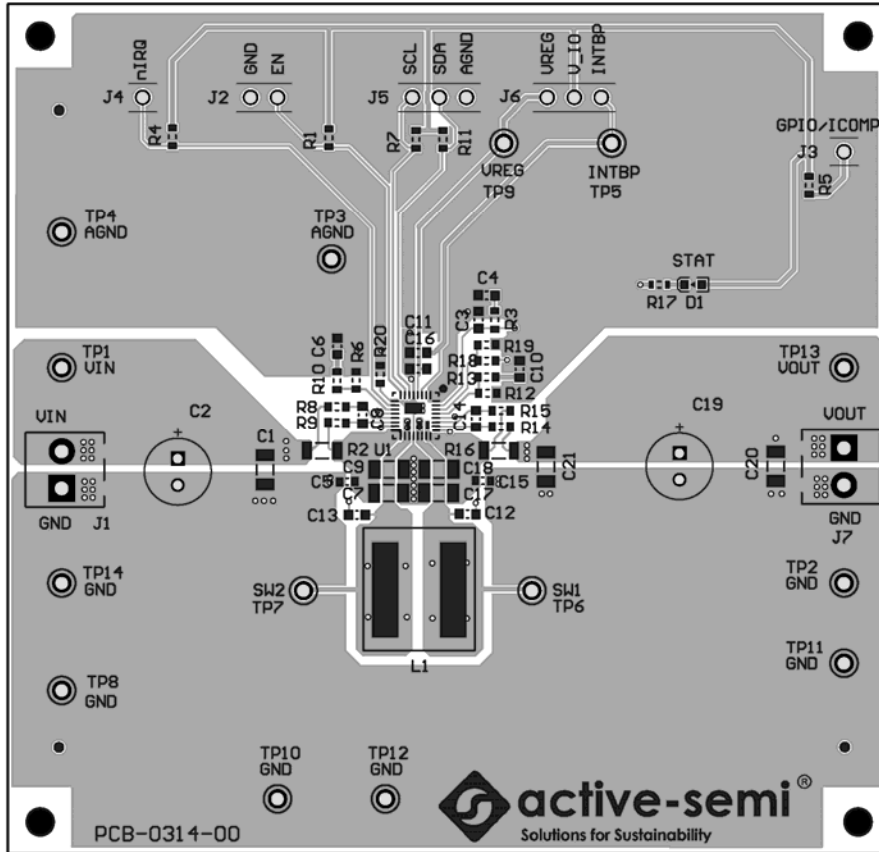

Figure 5 – Layout Top Layer

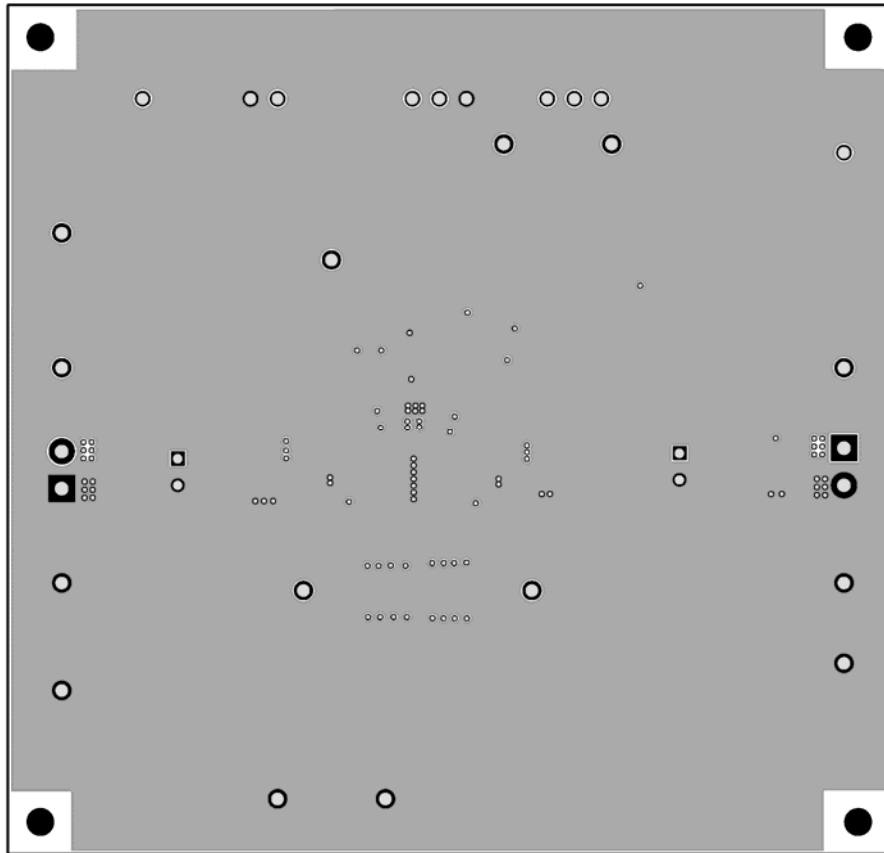

Figure 6 – Layout Layer GND

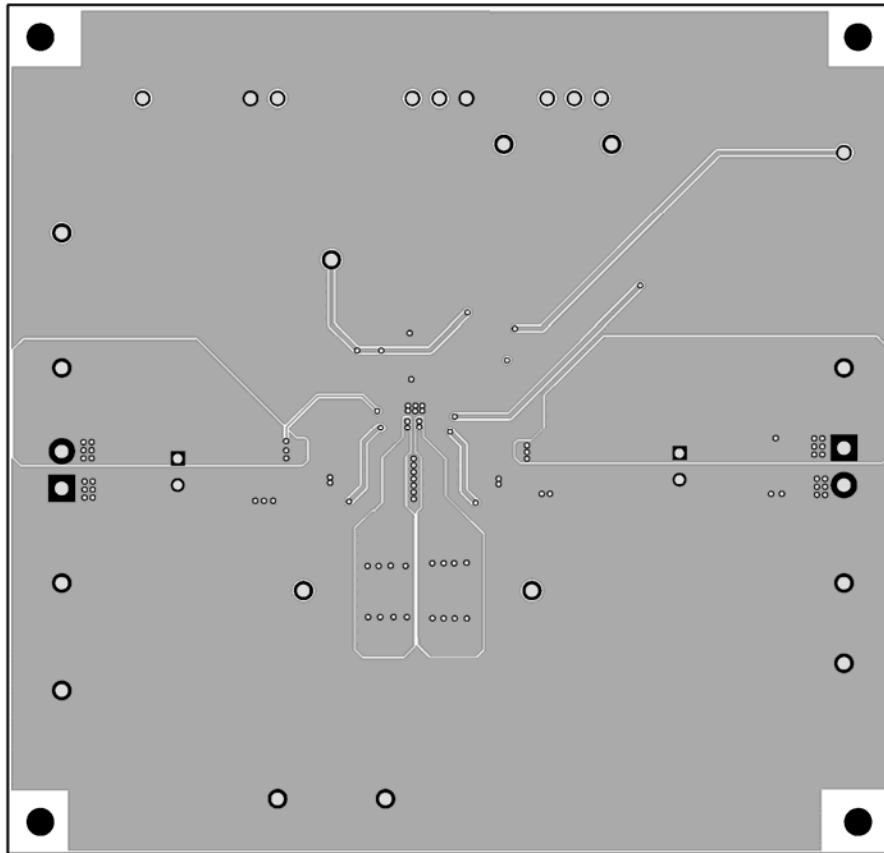
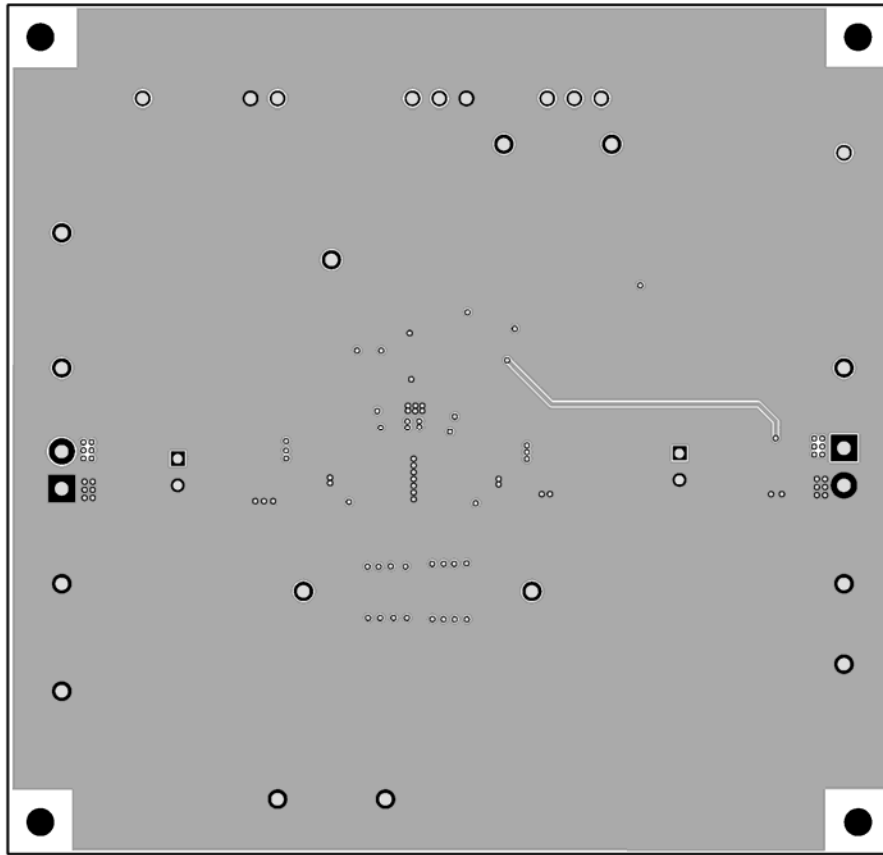

Figure 7 – Layout Layer VCC



**Figure 8 – Layout Bottom Layer**

**Bill of Materials**
**Table 2. ACT510x EVK BOM**

	ASSY-0314-00-00	ASSY-0314-00-01					
Item	QTY	QTY	Ref Des	Description	Package	MFR	Part Number
1	3	3	C1, C20, C21	Cap, Ceramic, 10uF, 35V, 10%, X5R	1206	Murata	GRM319R6YA106K A12
2	1	1	C2	ELCap, 100uF, 25V	6.3mmx1 1mm	Würth Elektronik	865080445010
3	1	1	C3	Cap, Ceramic, 2.2nF, 25V, 10%, X7R	0603	Würth Elektronik	885012206061
4	1	1	C4	Cap, Ceramic, 22nF, 25V, 10%, X7R	0603	Würth Elektronik	885012206067
5	5	5	C5, C8, C11, C14, C15	Cap, Ceramic, 100nF, 50V, 10%, X7R	0603	Würth Elektronik	885012206095
6	0	0	C6, C10	DNI	0603	std	std
7	4	4	C7, C9, C17, C18	Cap, Ceramic, 22uF, 35V, 10%, X5R	1206	TDK	C3216X5R1V226M 160AC
8	2	2	C12, C13	Cap, Ceramic, 47nF, 50V, 10%, X7R	0603	Würth Elektronik	885012206093
9	1	1	C16	Cap, Ceramic, 1uF, 10V, 10%, X7R	0603	Würth Elektronik	885012206026
10	1	1	C19	ELCap, 220uF, 25V	6.3mmx1 1mm	Würth Elektronik	860010473011
11	1	1	D1	SMD LED blue	0603	Würth Elektronik	150060BS75000
12	2	2	J1,J7	Connector, 2 pin	2141 S 3.50mm Horizontal Entry Modular	Würth Elektronik	691214110002S
13	1	1	J2	Header, 2pin, 100mil		Würth Elektronik	61300211121
14	2	2	J3,J4	Header, 1pin, 100mil		Würth Elektronik	61300111121
15	2	2	J5,J6	Header, 3pin, 100mil		Würth Elektronik	61300311121
16	1	1	L1	Inductor 10uH, 5A, 26.5mohm	6mmx6m mx6mm	Würth Elektronik	74439346100
17	3	3	R1, R4, R17	Res, 10kΩ, 1%	0603	std	std
18	1	1	R2	Res, 5mΩ, 1%	1206	std	std
19	2	2	R3, R12	Res, 20kΩ, 1%	0603	std	std
20	0	0	R5, R7, R10, R11, R13	DNI	0603	std	std
21	1	1	R6	Res, 36kΩ, 1%	0603	std	std
22	4	4	R8, R9, R14, R15	Res, 30Ω, 1%	0603	std	std

23	1	1	R16	Res, 10mΩ, 1%	1206	std	std
24	0	1	R18	Res, 200kΩ, 1%	0603	std	std
25	0	1	R19	Res, 133kΩ, 1%	0603	std	std
26	1	1	R20	Res, 0Ω, 1%	0603	std	std
27	6	6	TP1, TP5, TP6, TP7, TP9, TP13	Test Point, Red, Through Hole, 1mm	0.040"	Keystone	5000
28	9	9	TP2, TP3, TP4, TP6, TP8, TP10, TP11, TP12, TP14	Test Point, Black, Through Hole, 1mm	0.040"	Keystone	5001
29	1	0	U1	IC, ACT5101, Integrated Buck-Boost	QFN32-4x4	Active Semi	ACT5101QI102-T
	0	1		IC, ACT5102, Integrated Buck-Boost	QFN32-4x4	Active Semi	ACT5102QI102-T
30	1	1	--	PCB, ACT5101/02 EVK1 REVB	n/a	n/a	PCB-0314-00
31	2	2	--	Shunt, 100mil, Black	n/a	n/a	60900213421



## GUI Installation

1. Get GUI files from the Active Semi website
2. Plug the USB-TO-I2C dongle into a free USB port.
3. Follow the instructions in the “How to install driver for dongle” folder.
4. Double click on the ACT5101 GUI.exe to start the ACT5101 GUI.

名称	修改日期	类型	大小
Driver	2018/5/9 18:56	文件夹	
ACT5101_REV0.1.cpmu	2018/1/26 15:39	CPMU 文件	38 KB
<b>ActiveGUI_Simple_04Jan18</b>	2018/1/4 17:43	应用程序	2,683 KB
Active-Semi's GUI and Dongle Driver ...	2017/10/30 17:41	Adobe Acrobat ...	1,281 KB

## GUI Overview

The GUI has 2 basic function buttons allocated in top-left of the Tool Bar which are Read and Write I<sup>2</sup>C. The GUI contains 2 setting modes: Basic Mode and Advanced Mode. In Basic Mode screen it displays basic user programmable configuration options are programmed using the drop-down boxes or check boxes. Advanced Mode contain the button text for changing setting for every single bit.

### Basic Mode

The following figure show the GUI in basic mode. This mode allows the user to easily change one or more IC settings.

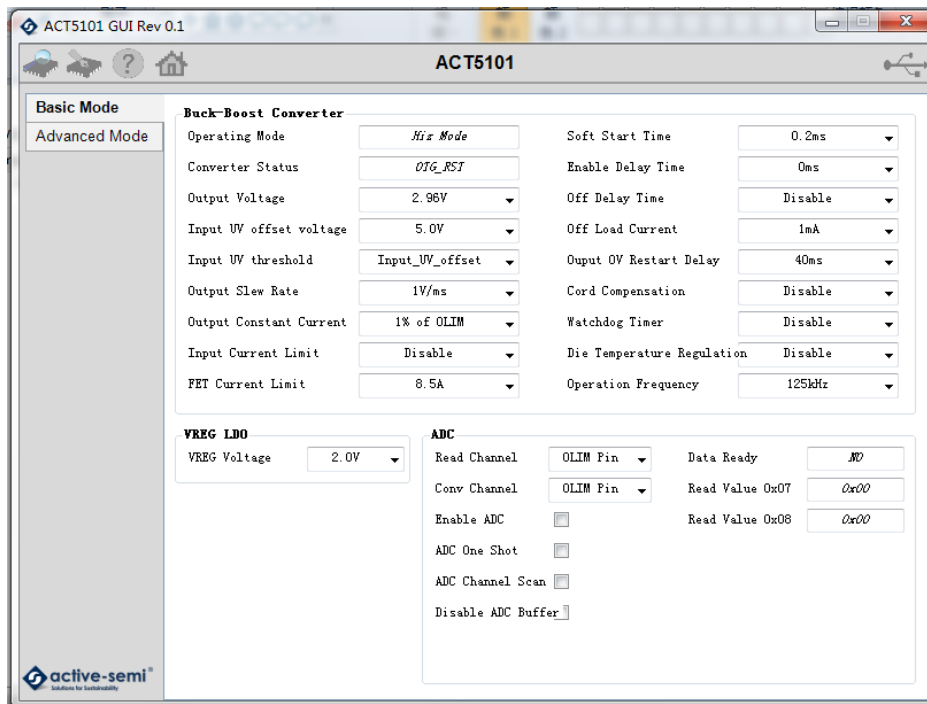

### Advanced Mode

Click the “Advanced Mode” button in the left of the GUI screen to see all available user programmable options. With Advanced Mode, additional user programmable features can be selected using the button text. In the left side of the Advanced Mode Screen, click on the Tiles Selector to display the register to view or change. Then change a register one bit at a time by clicking on the desired bit. The value of the bit is display right next to the bit-name button.

Note that the far right side of the screen contains a scroll down button to scroll down to additional registers since the Tile Screen can only display up to 8 bytes at once.

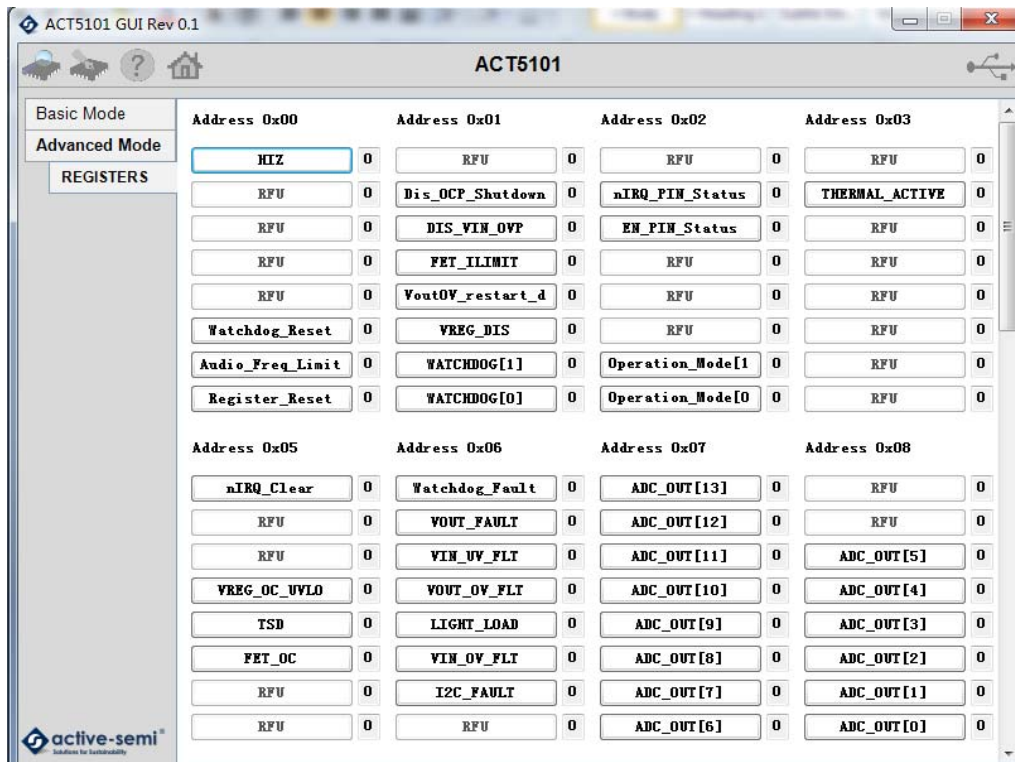

### Button Descriptions

**Read:** Clicking on this button reads the ACT2861 registers and displays them in the GUI. Note that this reads all registers. Active-Semi recommends reading registers each time the ACT2861 powers-up to acquire the initial register settings. Active-semi also recommends reading registers after making changes to them. Immediately reading the registers after a write confirms the changes were properly stored.

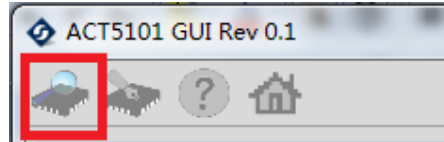

Read Button

**Write:** Clicking on this button writes the GUI settings to the ACT2861's registers. All registers are written, regardless of whether or not they were changed.

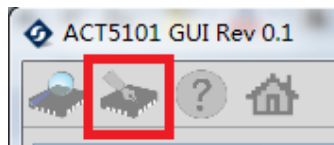

Write Button

**Dongle Connection Status:** The GUI also contains a dongle connection status that indicates Active-Semi's USB-TO-I2C dongle is connected to the USB port. The figure below shows the two possible indication status graphics.

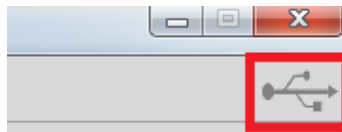

Dongle connected

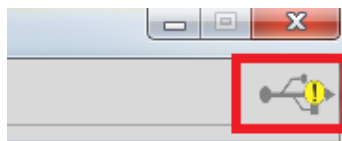

Dongle Disconnected

## Данный компонент на территории Российской Федерации

### Вы можете приобрести в компании MosChip.

Для оперативного оформления запроса Вам необходимо перейти по данной ссылке:

<http://moschip.ru/get-element>

Вы можете разместить у нас заказ для любого Вашего проекта, будь то серийное производство или разработка единичного прибора.

В нашем ассортименте представлены ведущие мировые производители активных и пассивных электронных компонентов.

Нашей специализацией является поставка электронной компонентной базы двойного назначения, продукции таких производителей как XILINX, Intel (ex.ALTERA), Vicor, Microchip, Texas Instruments, Analog Devices, Mini-Circuits, Amphenol, Glenair.

Сотрудничество с глобальными дистрибьюторами электронных компонентов, предоставляет возможность заказывать и получать с международных складов практически любой перечень компонентов в оптимальные для Вас сроки.

На всех этапах разработки и производства наши партнеры могут получить квалифицированную поддержку опытных инженеров.

Система менеджмента качества компании отвечает требованиям в соответствии с ГОСТ Р ИСО 9001, ГОСТ РВ 0015-002 и ЭС РД 009

### Офис по работе с юридическими лицами:

105318, г.Москва, ул.Щербаковская д.3, офис 1107, 1118, ДЦ «Щербаковский»

Телефон: +7 495 668-12-70 (многоканальный)

Факс: +7 495 668-12-70 (доб.304)

E-mail: [info@moschip.ru](mailto:info@moschip.ru)

Skype отдела продаж:

moschip.ru

moschip.ru\_4

moschip.ru\_6

moschip.ru\_9