

## MOSFET

### 600V CoolMOS™ CFD7 Power Transistor

CoolMOS™ is a revolutionary technology for high voltage power MOSFETs, designed according to the superjunction (SJ) principle and pioneered by Infineon Technologies. The latest CoolMOS™ CFD7 is the successor to the CoolMOS™ CFD2 series and is an optimized platform tailored to target soft switching applications such as phase-shift full-bridge (ZVS) and LLC. Resulting from reduced gate charge ( $Q_g$ ), best-in-class reverse recovery charge ( $Q_{rr}$ ) and improved turn off behavior CoolMOS™ CFD7 offers highest efficiency in resonant topologies. As part of Infineon's fast body diode portfolio, this new product series blends all advantages of a fast switching technology together with superior hard commutation robustness, without sacrificing easy implementation in the design-in process. The CoolMOS™ CFD7 technology meets highest efficiency and reliability standards and furthermore supports high power density solutions. Altogether, CoolMOS™ CFD7 makes resonant switching topologies more efficient, more reliable, lighter and cooler.

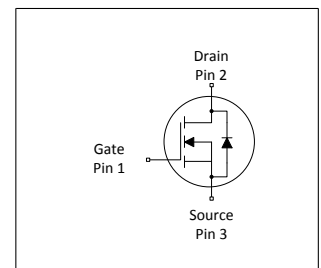

### Features

- Ultra-fast body diode
- Low gate charge
- Best-in-class reverse recovery charge ( $Q_{rr}$ )
- Improved MOSFET reverse diode  $dv/dt$  and  $di_f/dt$  ruggedness
- Lowest FOM  $R_{DS(on)} * Q_g$  and  $R_{DS(on)} * E_{oss}$
- Best-in-class  $R_{DS(on)}$  in SMD and THD packages

### Benefits

- Excellent hard commutation ruggedness
- Highest reliability for resonant topologies
- Highest efficiency with outstanding ease-of-use / performance tradeoff
- Enabling increased power density solutions

### Potential applications

Suitable for Soft Switching topologies  
Optimized for phase-shift full-bridge (ZVS), LLC Applications – Server, Telecom, EV Charging

**Product Validation:** Qualified for industrial applications according to the relevant tests of JEDEC47/20/22

*Please note: For MOSFET paralleling the use of ferrite beads on the gate or separate totem poles is generally recommended.*

**Table 1 Key Performance Parameters**

Parameter	Value	Unit
$V_{DS} @ T_{j,max}$	650	V
$R_{DS(on),max}$	145	m $\Omega$
$Q_{g,typ}$	31	nC
$I_{D,pulse}$	58	A
$E_{oss} @ 400V$	3.6	$\mu$ J
Body diode $di_f/dt$	1300	A/ $\mu$ s

Type / Ordering Code	Package	Marking	Related Links
IPW60R145CFD7	PG-TO 247-3	60R145F7	see Appendix A

## Table of Contents

Description .....	1
Maximum ratings .....	3
Thermal characteristics .....	4
Electrical characteristics .....	5
Electrical characteristics diagrams .....	7
Test Circuits .....	11
Package Outlines .....	12
Appendix A .....	13
Revision History .....	14
Trademarks .....	14
Disclaimer .....	14

## 1 Maximum ratings

at  $T_j = 25^\circ\text{C}$ , unless otherwise specified

**Table 2 Maximum ratings**

Parameter	Symbol	Values			Unit	Note / Test Condition
		Min.	Typ.	Max.		
Continuous drain current <sup>1)</sup>	$I_D$	-	-	16 10.0	A	$T_C=25^\circ\text{C}$ $T_C=100^\circ\text{C}$
Pulsed drain current <sup>2)</sup>	$I_{D,pulse}$	-	-	58	A	$T_C=25^\circ\text{C}$
Avalanche energy, single pulse	$E_{AS}$	-	-	68	mJ	$I_D=4.1\text{A}$ ; $V_{DD}=50\text{V}$ ; see table 10
Avalanche energy, repetitive	$E_{AR}$	-	-	0.34	mJ	$I_D=4.1\text{A}$ ; $V_{DD}=50\text{V}$ ; see table 10
Avalanche current, single pulse	$I_{AS}$	-	-	4.1	A	-
MOSFET dv/dt ruggedness	dv/dt	-	-	120	V/ns	$V_{DS}=0\dots400\text{V}$
Gate source voltage (static)	$V_{GS}$	-20	-	20	V	static;
Gate source voltage (dynamic)	$V_{GS}$	-30	-	30	V	AC ( $f>1\text{Hz}$ )
Power dissipation	$P_{tot}$	-	-	83	W	$T_C=25^\circ\text{C}$
Storage temperature	$T_{stg}$	-55	-	150	$^\circ\text{C}$	-
Operating junction temperature	$T_j$	-55	-	150	$^\circ\text{C}$	-
Mounting torque	-	-	-	60	Ncm	M3 and M3.5 screws
Continuous diode forward current	$I_S$	-	-	16	A	$T_C=25^\circ\text{C}$
Diode pulse current <sup>2)</sup>	$I_{S,pulse}$	-	-	58	A	$T_C=25^\circ\text{C}$
Reverse diode dv/dt <sup>3)</sup>	dv/dt	-	-	70	V/ns	$V_{DS}=0\dots400\text{V}$ , $I_{SD}\leq 16\text{A}$ , $T_j=25^\circ\text{C}$ see table 8
Maximum diode commutation speed	di <sub>F</sub> /dt	-	-	1300	A/ $\mu\text{s}$	$V_{DS}=0\dots400\text{V}$ , $I_{SD}\leq 16\text{A}$ , $T_j=25^\circ\text{C}$ see table 8
Insulation withstand voltage	$V_{ISO}$	-	-	n.a.	V	$V_{rms}$ , $T_C=25^\circ\text{C}$ , $t=1\text{min}$

<sup>1)</sup> Limited by  $T_{j,max}$ .

<sup>2)</sup> Pulse width  $t_p$  limited by  $T_{j,max}$

<sup>3)</sup> Identical low side and high side switch with identical  $R_\theta$

## 2 Thermal characteristics

**Table 3 Thermal characteristics**

Parameter	Symbol	Values			Unit	Note / Test Condition
		Min.	Typ.	Max.		
Thermal resistance, junction - case	$R_{thJC}$	-	-	1.51	°C/W	-
Thermal resistance, junction - ambient	$R_{thJA}$	-	-	62	°C/W	leaded
Thermal resistance, junction - ambient for SMD version	$R_{thJA}$	-	-	-	°C/W	n.a.
Soldering temperature, wavesoldering only allowed at leads	$T_{sold}$	-	-	260	°C	1.6mm (0.063 in.) from case for 10s

### 3 Electrical characteristics

at  $T_j=25^\circ\text{C}$ , unless otherwise specified

**Table 4 Static characteristics**

Parameter	Symbol	Values			Unit	Note / Test Condition
		Min.	Typ.	Max.		
Drain-source breakdown voltage	$V_{(BR)DSS}$	600	-	-	V	$V_{GS}=0V, I_D=1mA$
Gate threshold voltage	$V_{(GS)th}$	3.5	4	4.5	V	$V_{DS}=V_{GS}, I_D=0.34mA$
Zero gate voltage drain current <sup>1)</sup>	$I_{DSS}$	-	-	1	$\mu A$	$V_{DS}=600V, V_{GS}=0V, T_j=25^\circ C$ $V_{DS}=600V, V_{GS}=0V, T_j=125^\circ C$
Gate-source leakage current	$I_{GSS}$	-	-	100	nA	$V_{GS}=20V, V_{DS}=0V$
Drain-source on-state resistance	$R_{DS(on)}$	-	0.127	0.145	$\Omega$	$V_{GS}=10V, I_D=6.8A, T_j=25^\circ C$ $V_{GS}=10V, I_D=6.8A, T_j=150^\circ C$
Gate resistance	$R_G$	-	10	-	$\Omega$	$f=1MHz, \text{open drain}$

**Table 5 Dynamic characteristics**

Parameter	Symbol	Values			Unit	Note / Test Condition
		Min.	Typ.	Max.		
Input capacitance	$C_{iss}$	-	1330	-	pF	$V_{GS}=0V, V_{DS}=400V, f=250kHz$
Output capacitance	$C_{oss}$	-	24	-	pF	$V_{GS}=0V, V_{DS}=400V, f=250kHz$
Effective output capacitance, energy related <sup>2)</sup>	$C_{o(er)}$	-	44	-	pF	$V_{GS}=0V, V_{DS}=0...400V$
Effective output capacitance, time related <sup>3)</sup>	$C_{o(tr)}$	-	453	-	pF	$I_D=\text{constant}, V_{GS}=0V, V_{DS}=0...400V$
Turn-on delay time	$t_{d(on)}$	-	27	-	ns	$V_{DD}=400V, V_{GS}=10V, I_D=7.3A,$ $R_G=5.3\Omega; \text{see table 9}$
Rise time	$t_r$	-	18	-	ns	$V_{DD}=400V, V_{GS}=10V, I_D=7.3A,$ $R_G=5.3\Omega; \text{see table 9}$
Turn-off delay time	$t_{d(off)}$	-	71	-	ns	$V_{DD}=400V, V_{GS}=10V, I_D=7.3A,$ $R_G=5.3\Omega; \text{see table 9}$
Fall time	$t_f$	-	7.2	-	ns	$V_{DD}=400V, V_{GS}=10V, I_D=7.3A,$ $R_G=5.3\Omega; \text{see table 9}$

**Table 6 Gate charge characteristics**

Parameter	Symbol	Values			Unit	Note / Test Condition
		Min.	Typ.	Max.		
Gate to source charge	$Q_{GS}$	-	8	-	nC	$V_{DD}=400V, I_D=7.3A, V_{GS}=0 \text{ to } 10V$
Gate to drain charge	$Q_{gd}$	-	10	-	nC	$V_{DD}=400V, I_D=7.3A, V_{GS}=0 \text{ to } 10V$
Gate charge total	$Q_g$	-	31	-	nC	$V_{DD}=400V, I_D=7.3A, V_{GS}=0 \text{ to } 10V$
Gate plateau voltage	$V_{plateau}$	-	5.7	-	V	$V_{DD}=400V, I_D=7.3A, V_{GS}=0 \text{ to } 10V$

<sup>1)</sup> Maximum specification is defined by calculated six sigma upper confidence bound

<sup>2)</sup>  $C_{o(er)}$  is a fixed capacitance that gives the same stored energy as  $C_{oss}$  while  $V_{DS}$  is rising from 0 to 400V

<sup>3)</sup>  $C_{o(tr)}$  is a fixed capacitance that gives the same charging time as  $C_{oss}$  while  $V_{DS}$  is rising from 0 to 400V

**Table 7 Reverse diode characteristics**

Parameter	Symbol	Values			Unit	Note / Test Condition
		Min.	Typ.	Max.		
Diode forward voltage	$V_{SD}$	-	1.0	-	V	$V_{GS}=0V, I_F=6.8A, T_j=25^\circ C$
Reverse recovery time	$t_{rr}$	-	102	204	ns	$V_R=400V, I_F=7.3A, di_F/dt=100A/\mu s$ ; see table 8
Reverse recovery charge	$Q_{rr}$	-	0.45	0.9	$\mu C$	$V_R=400V, I_F=7.3A, di_F/dt=100A/\mu s$ ; see table 8
Peak reverse recovery current	$I_{rrm}$	-	8	-	A	$V_R=400V, I_F=7.3A, di_F/dt=100A/\mu s$ ; see table 8

### 4 Electrical characteristics diagrams

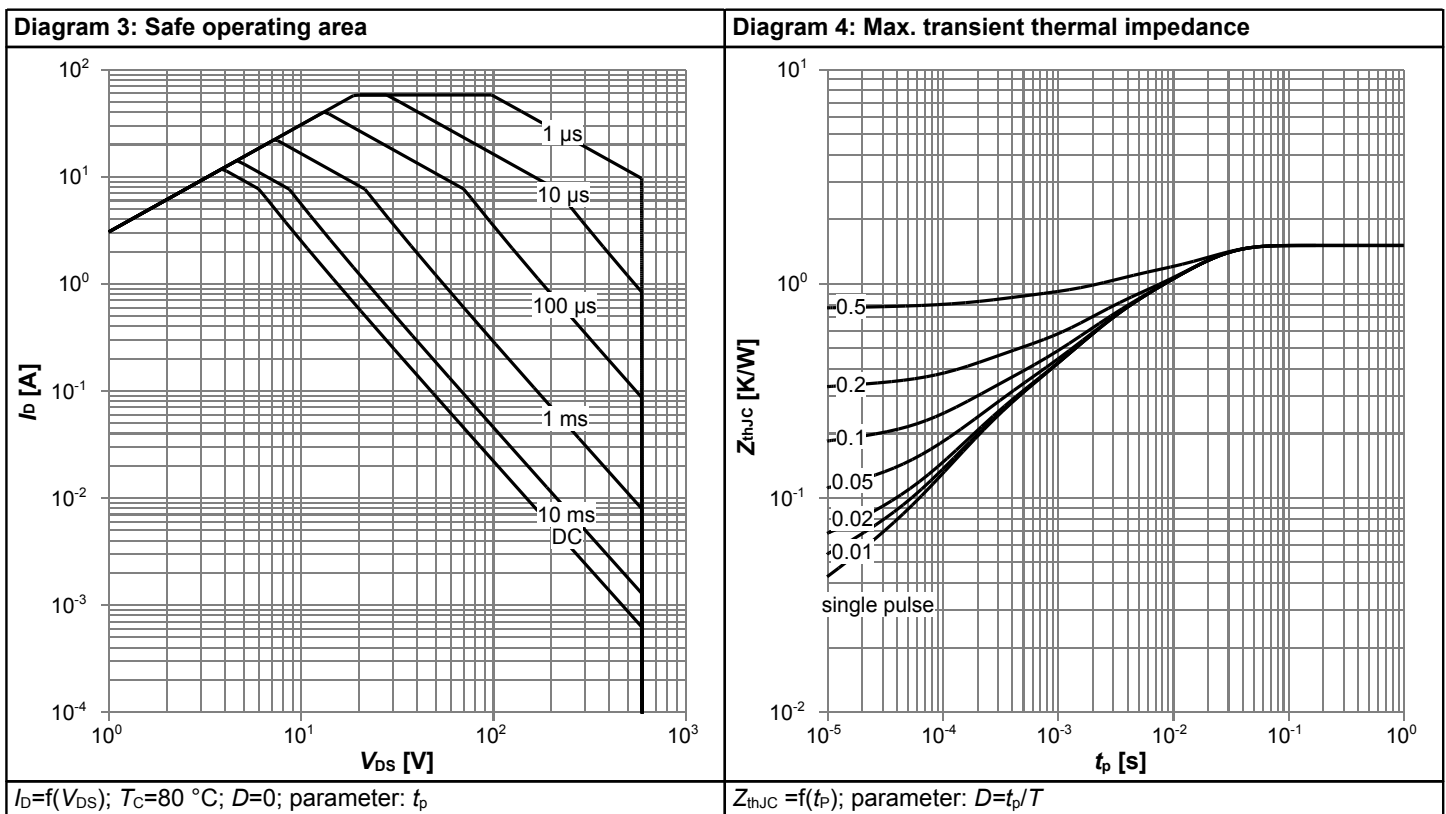
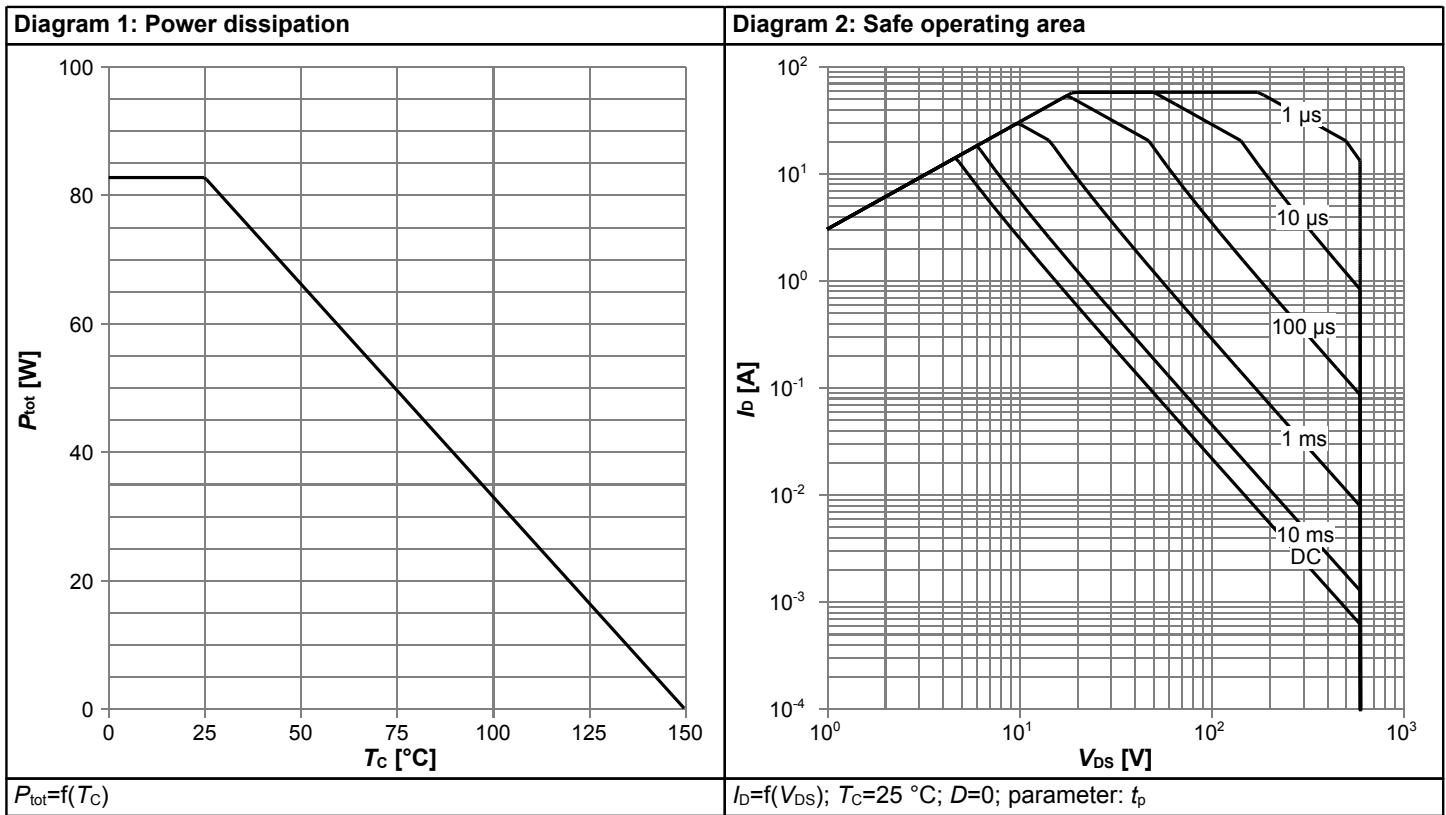

# 600V CoolMOS™ CFD7 Power Transistor

## IPW60R145CFD7

Diagram 5: Typ. output characteristics

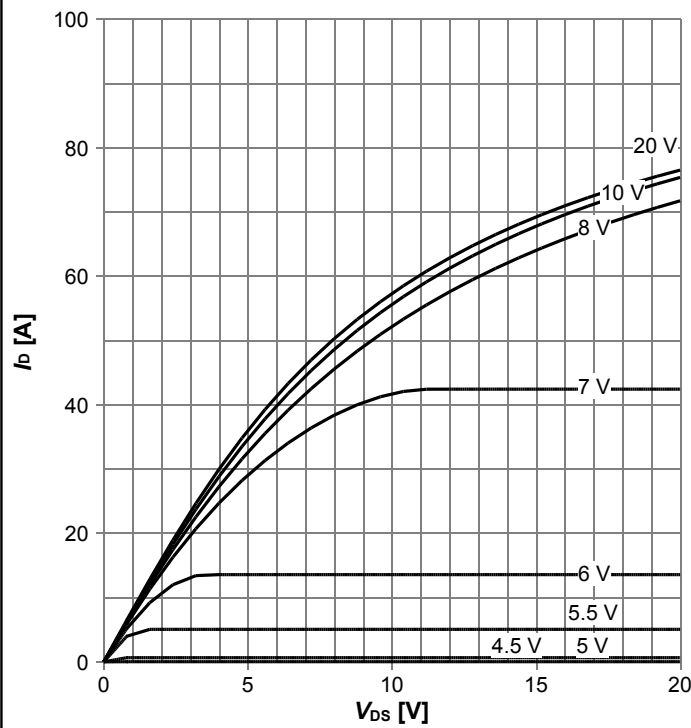

$I_D=f(V_{DS})$ ;  $T_j=25\text{ °C}$ ; parameter:  $V_{GS}$

Diagram 6: Typ. output characteristics

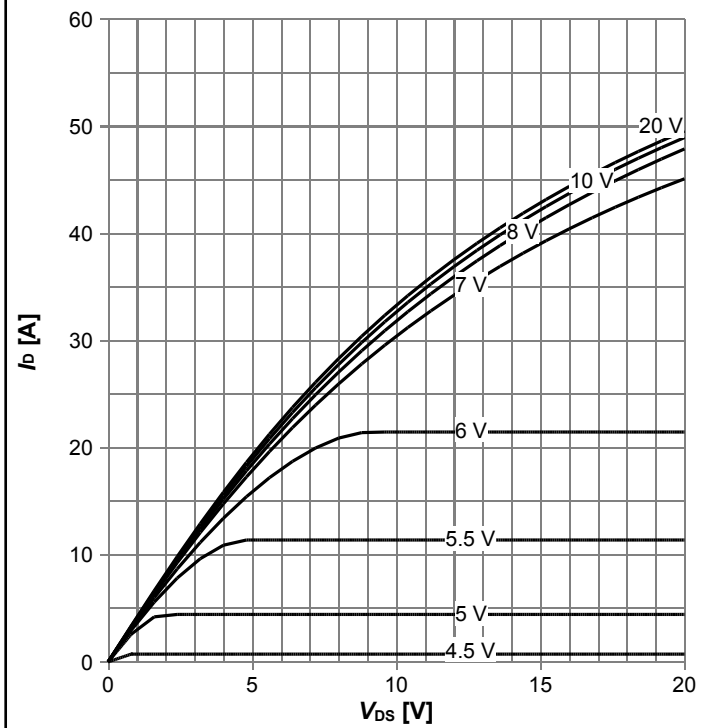

$I_D=f(V_{DS})$ ;  $T_j=125\text{ °C}$ ; parameter:  $V_{GS}$

Diagram 7: Typ. drain-source on-state resistance

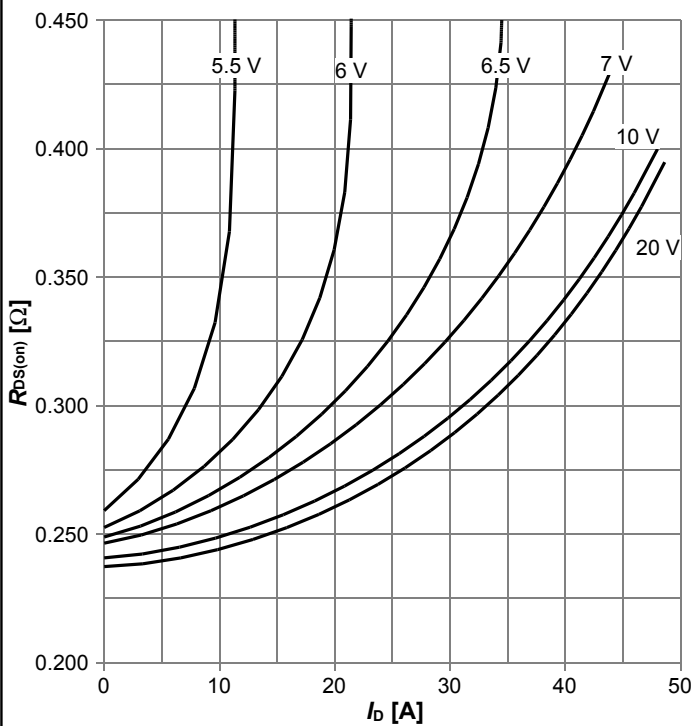

$R_{DS(on)}=f(I_D)$ ;  $T_j=125\text{ °C}$ ; parameter:  $V_{GS}$

Diagram 8: Drain-source on-state resistance

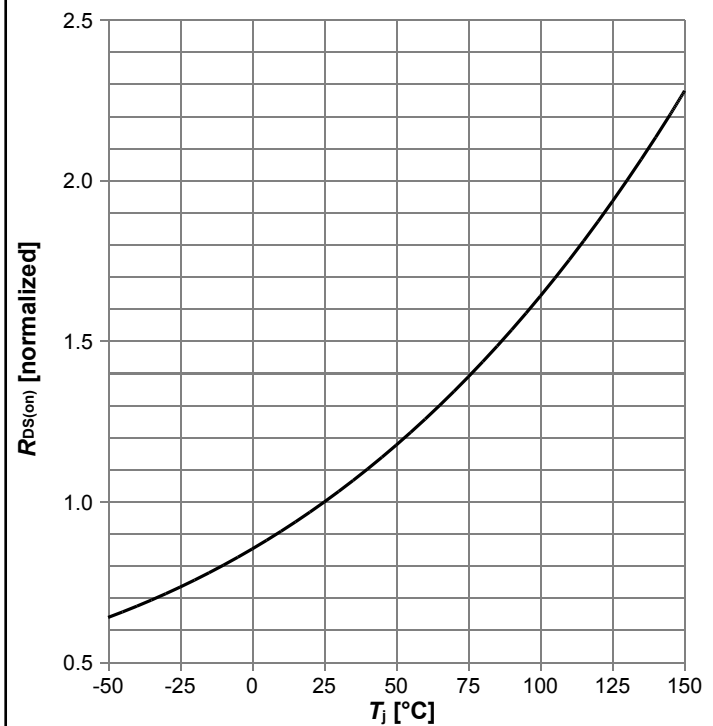

$R_{DS(on)}=f(T_j)$ ;  $I_D=6.8\text{ A}$ ;  $V_{GS}=10\text{ V}$

# 600V CoolMOS™ CFD7 Power Transistor

## IPW60R145CFD7

**Diagram 9: Typ. transfer characteristics**

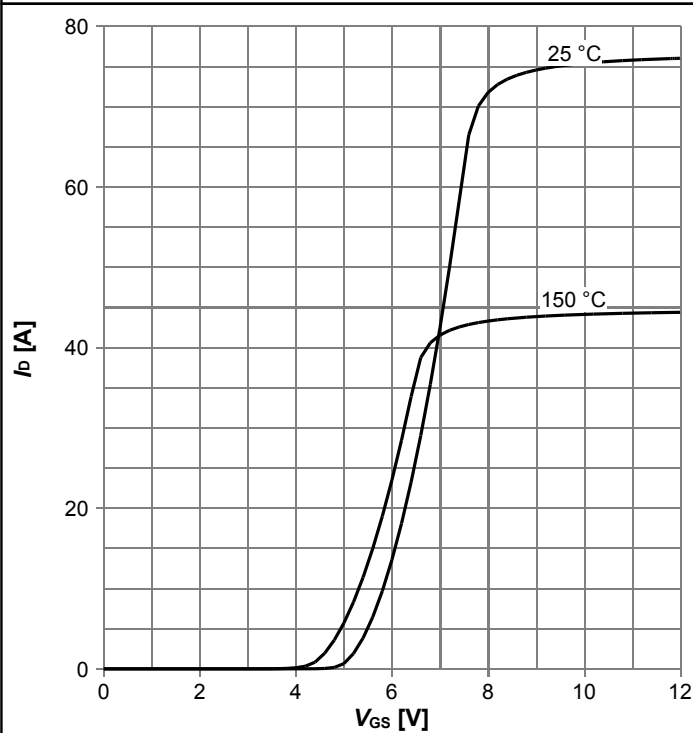

$I_D = f(V_{GS})$ ;  $V_{DS} = 20V$ ; parameter:  $T_j$

**Diagram 10: Typ. gate charge**

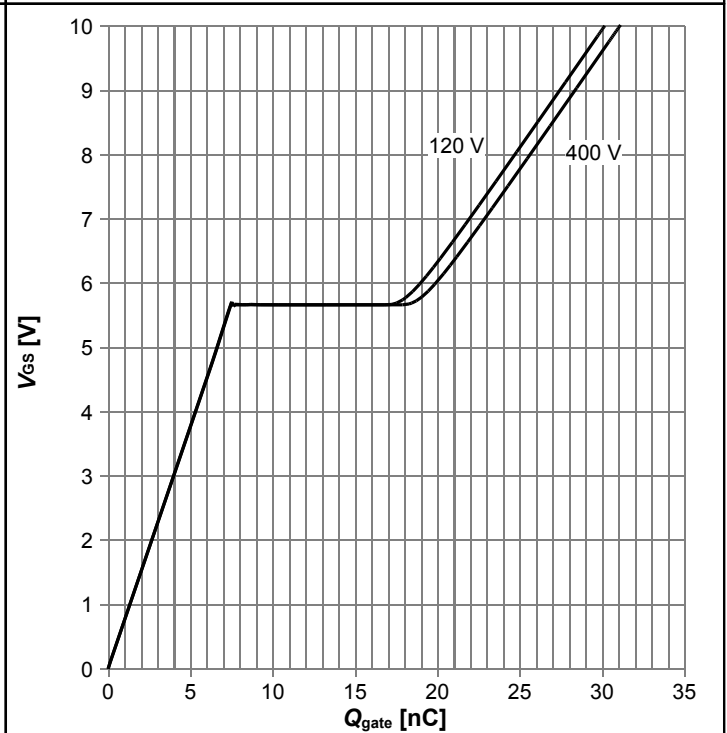

$V_{GS} = f(Q_{gate})$ ;  $I_D = 7.3$  A pulsed; parameter:  $V_{DD}$

**Diagram 11: Forward characteristics of reverse diode**

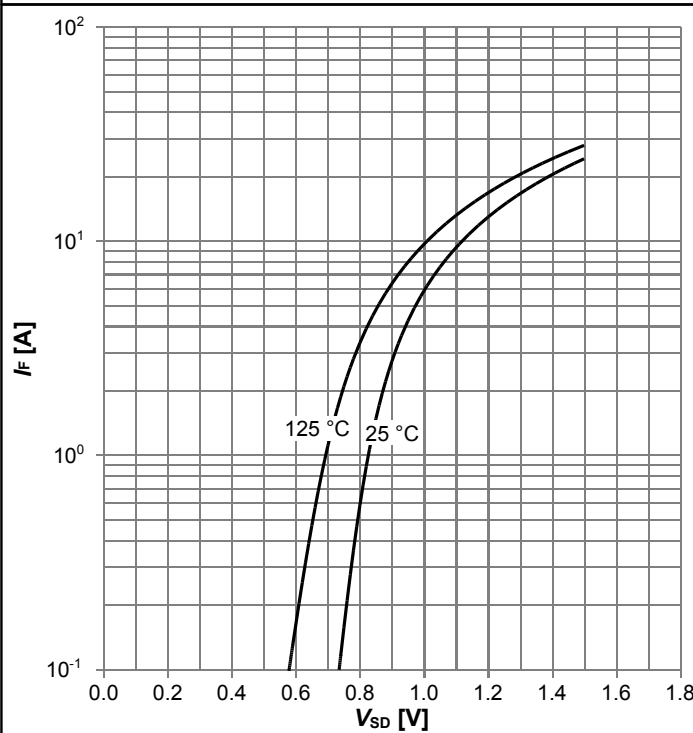

$I_F = f(V_{SD})$ ; parameter:  $T_j$

**Diagram 12: Avalanche energy**

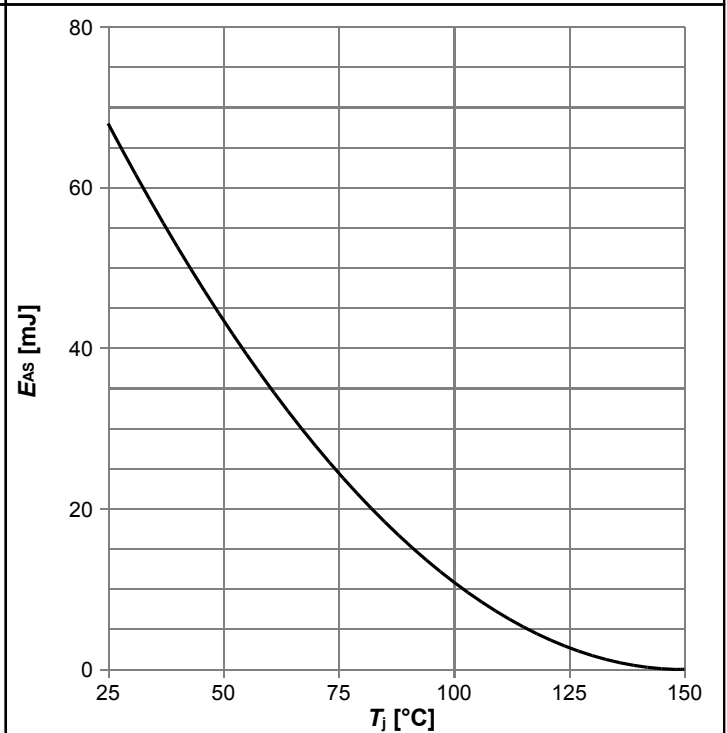

$E_{AS} = f(T_j)$ ;  $I_D = 4.0$  A;  $V_{DD} = 50$  V

# 600V CoolMOS™ CFD7 Power Transistor

## IPW60R145CFD7

**Diagram 13: Drain-source breakdown voltage**

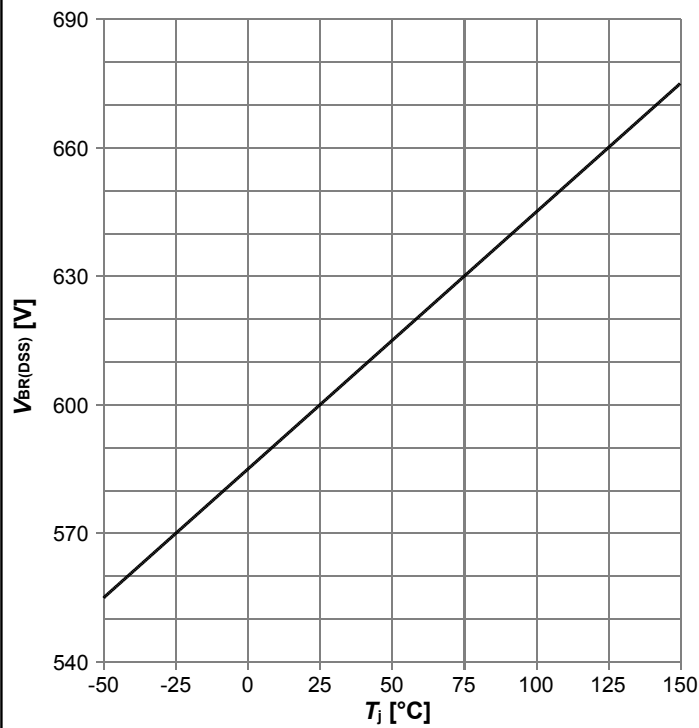

$V_{BR(DSS)}=f(T_j); I_D=1 \text{ mA}$

**Diagram 14: Typ. capacitances**

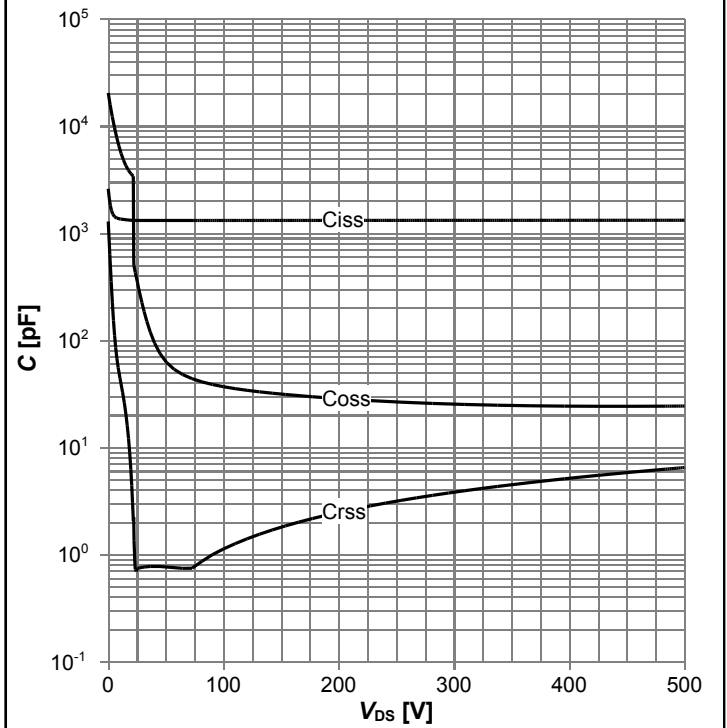

$C=f(V_{DS}); V_{GS}=0 \text{ V}; f=250 \text{ kHz}$

**Diagram 15: Typ. Coss stored energy**

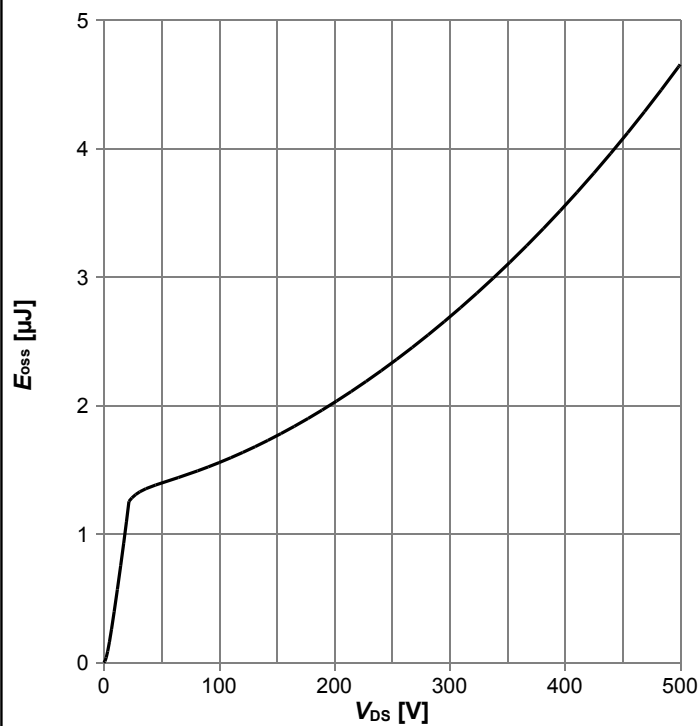

$E_{oss}=f(V_{DS})$

## 5 Test Circuits

**Table 8 Diode characteristics**

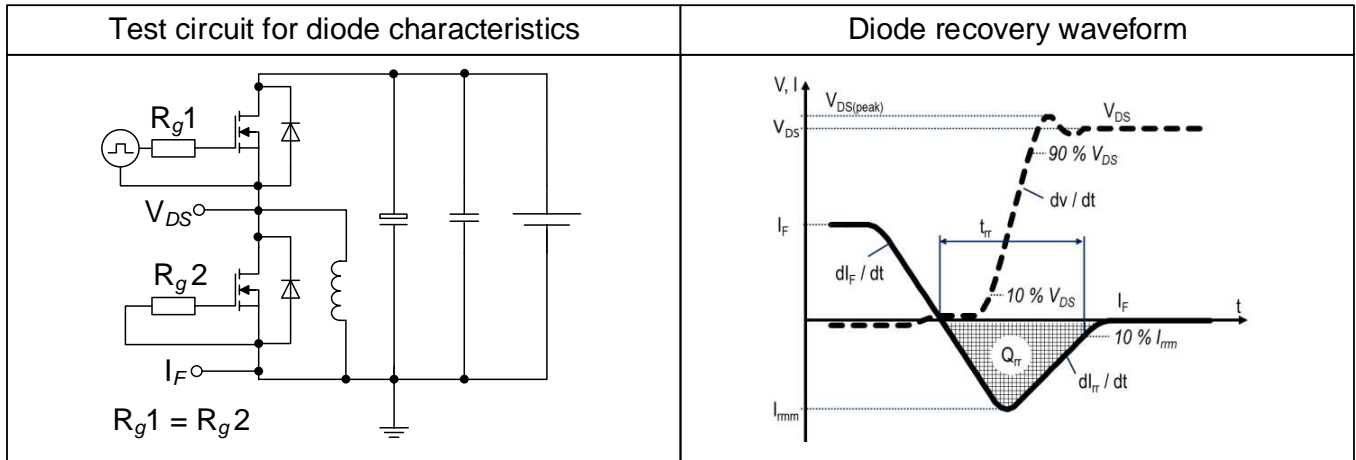

**Table 9 Switching times**

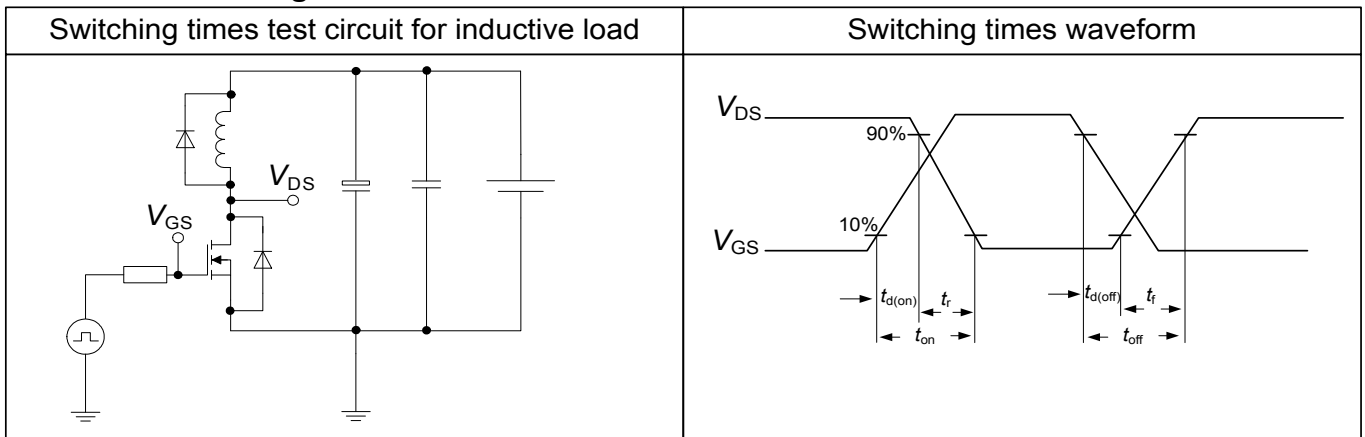

**Table 10 Unclamped inductive load**

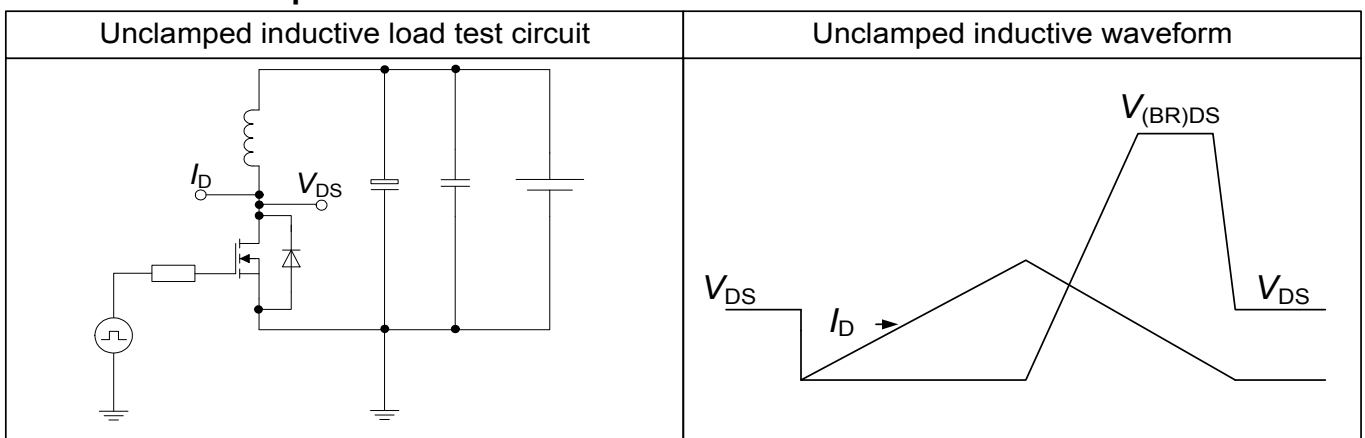

**6 Package Outlines**

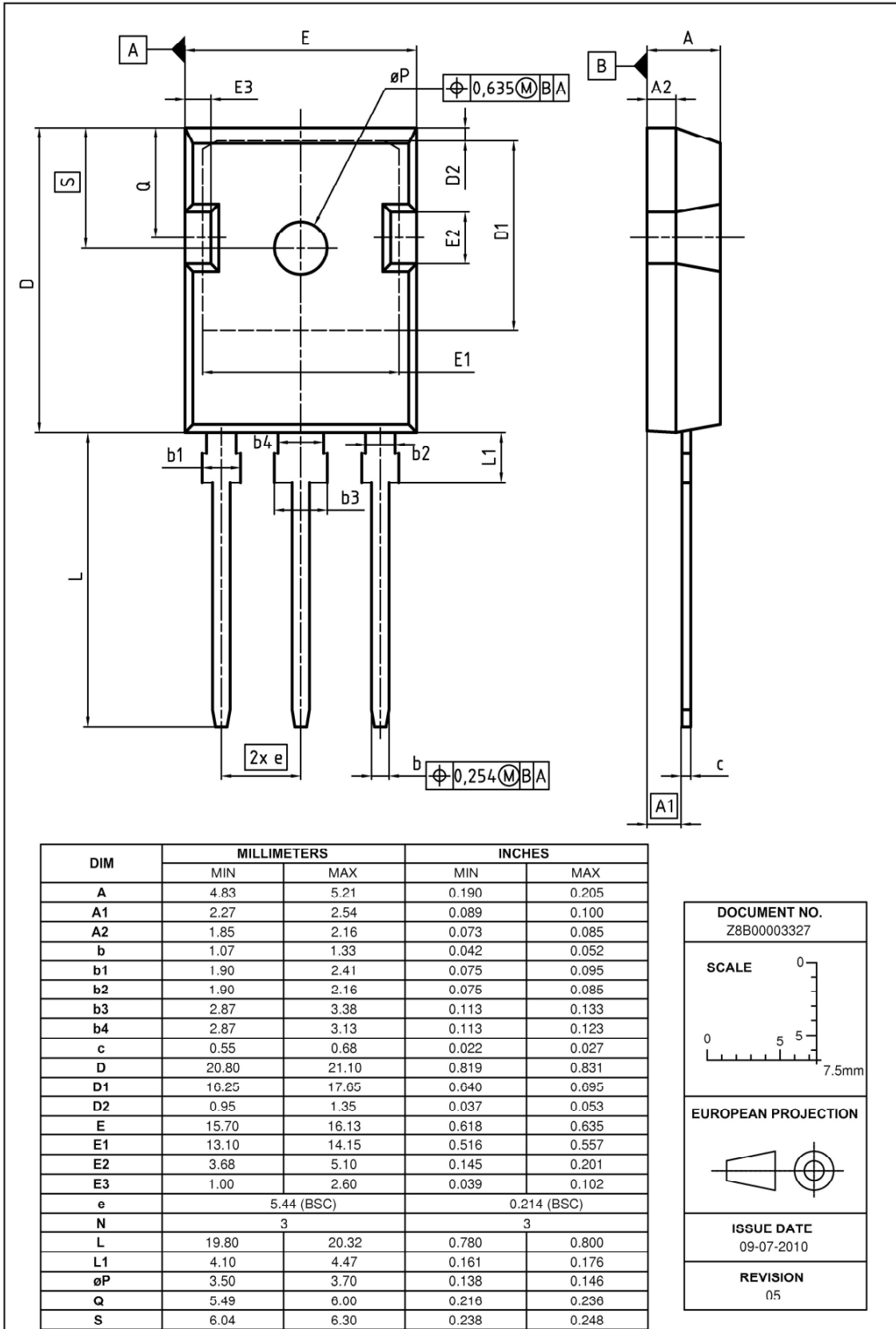

**Figure 1 Outline PG-TO 247-3, dimensions in mm/inches**

## 7 Appendix A

### Table 11 Related Links

- IFX CoolMOS CFD7 Webpage: [www.infineon.com](http://www.infineon.com)
- IFX CoolMOS CFD7 application note: [www.infineon.com](http://www.infineon.com)
- IFX CoolMOS CFD7 simulation model: [www.infineon.com](http://www.infineon.com)
- IFX Design tools: [www.infineon.com](http://www.infineon.com)

# 600V CoolMOS™ CFD7 Power Transistor

## IPW60R145CFD7

### Revision History

IPW60R145CFD7

**Revision: 2018-04-20, Rev. 2.0**

Previous Revision

Revision	Date	Subjects (major changes since last revision)
2.0	2018-04-20	Release of final version

#### Trademarks of Infineon Technologies AG

AURIX™, C166™, CanPAK™, CIPOS™, CoolGaN™, CoolMOS™, CoolSET™, CoolSiC™, CORECONTROL™, CROSSAVE™, DAVE™, DI-POL™, DrBlade™, EasyPIM™, EconoBRIDGE™, EconoDUAL™, EconoPACK™, EconoPIM™, EiceDRIVER™, eupec™, FCOS™, HITFET™, HybridPACK™, Infineon™, ISOFACE™, IsoPACK™, i-Wafer™, MIPAQ™, ModSTACK™, my-d™, NovalithIC™, OmniTune™, OPTIGA™, OptiMOS™, ORIGA™, POWERCODE™, PRIMARION™, PrimePACK™, PrimeSTACK™, PROFET™, PRO-SIL™, RASIC™, REAL3™, ReverSave™, SatRIC™, SIEGET™, SIPMOS™, SmartLEWIS™, SOLID FLASH™, SPOC™, TEMPFET™, thinQ!™, TRENCHSTOP™, TriCore™.

Trademarks updated August 2015

#### Other Trademarks

All referenced product or service names and trademarks are the property of their respective owners.

#### We Listen to Your Comments

Any information within this document that you feel is wrong, unclear or missing at all? Your feedback will help us to continuously improve the quality of this document. Please send your proposal (including a reference to this document) to:

[erratum@infineon.com](mailto:erratum@infineon.com)

#### Published by

**Infineon Technologies AG**

**81726 München, Germany**

**© 2018 Infineon Technologies AG**

**All Rights Reserved.**

#### Legal Disclaimer

The information given in this document shall in no event be regarded as a guarantee of conditions or characteristics ("Beschaffheitsgarantie").

With respect to any examples, hints or any typical values stated herein and/or any information regarding the application of the product, Infineon Technologies hereby disclaims any and all warranties and liabilities of any kind, including without limitation warranties of non-infringement of intellectual property rights of any third party.

In addition, any information given in this document is subject to customer's compliance with its obligations stated in this document and any applicable legal requirements, norms and standards concerning customer's products and any use of the product of Infineon Technologies in customer's applications.

The data contained in this document is exclusively intended for technically trained staff. It is the responsibility of customer's technical departments to evaluate the suitability of the product for the intended application and the completeness of the product information given in this document with respect to such application.

#### Information

For further information on technology, delivery terms and conditions and prices please contact your nearest Infineon Technologies Office ([www.infineon.com](http://www.infineon.com)).

#### Warnings

Due to technical requirements, components may contain dangerous substances. For information on the types in question, please contact the nearest Infineon Technologies Office.

The Infineon Technologies component described in this Data Sheet may be used in life-support devices or systems and/or automotive, aviation and aerospace applications or systems only with the express written approval of Infineon Technologies, if a failure of such components can reasonably be expected to cause the failure of that life-support, automotive, aviation and aerospace device or system or to affect the safety or effectiveness of that device or system. Life support devices or systems are intended to be implanted in the human body or to support and/or maintain and sustain and/or protect human life. If they fail, it is reasonable to assume that the health of the user or other persons may be endangered.

## Данный компонент на территории Российской Федерации

### Вы можете приобрести в компании MosChip.

Для оперативного оформления запроса Вам необходимо перейти по данной ссылке:

<http://moschip.ru/get-element>

Вы можете разместить у нас заказ для любого Вашего проекта, будь то серийное производство или разработка единичного прибора.

В нашем ассортименте представлены ведущие мировые производители активных и пассивных электронных компонентов.

Нашей специализацией является поставка электронной компонентной базы двойного назначения, продукции таких производителей как XILINX, Intel (ex.ALTERA), Vicor, Microchip, Texas Instruments, Analog Devices, Mini-Circuits, Amphenol, Glenair.

Сотрудничество с глобальными дистрибьюторами электронных компонентов, предоставляет возможность заказывать и получать с международных складов практически любой перечень компонентов в оптимальные для Вас сроки.

На всех этапах разработки и производства наши партнеры могут получить квалифицированную поддержку опытных инженеров.

Система менеджмента качества компании отвечает требованиям в соответствии с ГОСТ Р ИСО 9001, ГОСТ РВ 0015-002 и ЭС РД 009

### Офис по работе с юридическими лицами:

105318, г.Москва, ул.Щербаковская д.3, офис 1107, 1118, ДЦ «Щербаковский»

Телефон: +7 495 668-12-70 (многоканальный)

Факс: +7 495 668-12-70 (доб.304)

E-mail: [info@moschip.ru](mailto:info@moschip.ru)

Skype отдела продаж:

moschip.ru

moschip.ru\_4

moschip.ru\_6

moschip.ru\_9