

## GAAS MMIC VOLTAGE VARIABLE ATTENUATOR, 0.5 - 5.0 GHz

### Typical Applications

The HMC973ALP3E is ideal for:

- Point-to-Point Radio
- Cellular/3G & WiMAX/4G Infrastructure
- Test Instrumentation
- Microwave Sensors
- Military, ECM & Radar

### Features

- Wide Attenuation Range: 26 dB
- Single Positive Voltage Control: 0 to +5V
- Absorptive Topology
- 16 Lead 3x3mm SMT Package: 9 mm<sup>2</sup>

### Functional Diagram

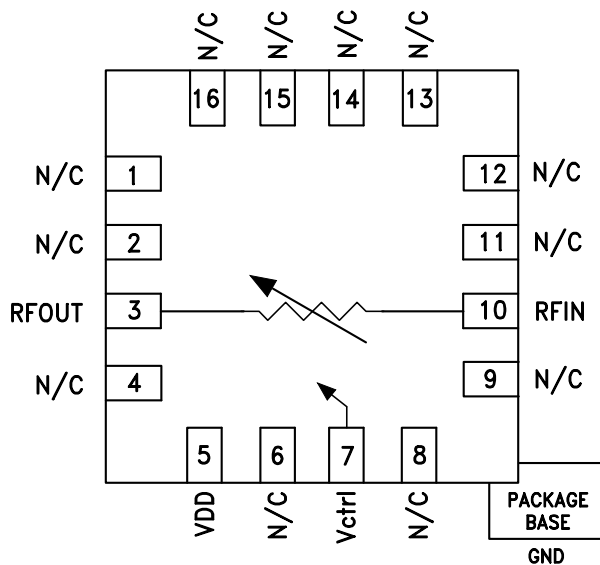

### General Description

The HMC973ALP3E is an absorptive Voltage Variable Attenuator (VVA) which operates from 0.5 to 5 GHz and is ideal in designs where an analog DC control signal must be used to control RF signal levels over a 26 dB amplitude range. It features a shunt-type attenuator controlled by an analog voltage, Vctrl. The HMC973ALP3E is an unidirectional device with optimum linearity performance achieved when the RF input signal is applied to the RFIN package lead. The HMC973ALP3E is housed in a RoHS compliant 3x3 mm QFN leadless package.

### Electrical Specifications, T<sub>A</sub> = +25° C, 50 Ohm system, V<sub>dd</sub> = +5V

Parameter	Frequency	Min.	Typ.	Max.	Units
Insertion Loss	0.5 - 2.0 GHz		3.3		dB
	2.0 - 4.0 GHz		4.2		dB
	4.0 - 5.0 GHz		5.6		dB
Attenuation Range	0.5 - 2.0 GHz		26		dB
	2.0 - 4.0 GHz		28		dB
	4.0 - 5.0 GHz		31		dB
Input Return Loss	0.5 - 2.0 GHz		10		dB
	2.0 - 5.0 GHz		13		dB
Output Return Loss	0.5 - 2.0 GHz		8		dB
	2.0 - 5.0 GHz		9		dB
Input Power for 1 dB Compression	0.5 - 5.0 GHz		25		dBm
Input Third Order Intercept (All Control Voltages) (Two-tone Input Power = +5 dBm Each Tone)	0.5 - 5.0 GHz		30		dBm
Supply Current (I <sub>dd</sub> )	0.5 - 5.0 GHz		600		μA

Information furnished by Analog Devices is believed to be accurate and reliable. However, no responsibility is assumed by Analog Devices for its use, nor for any infringements of patents or other rights of third parties that may result from its use. Specifications subject to change without notice. No license is granted by implication or otherwise under any patent or patent rights of Analog Devices. Trademarks and registered trademarks are the property of their respective owners.

For price, delivery, and to place orders: Analog Devices, Inc., One Technology Way, P.O. Box 9106, Norwood, MA 02062-9106  
 Phone: 781-329-4700 • Order online at [www.analog.com](http://www.analog.com)  
 Application Support: Phone: 1-800-ANALOG-D

**GAAS MMIC VOLTAGE VARIABLE ATTENUATOR, 0.5 - 5.0 GHz**

**Insertion Loss vs. Frequency Over Temperature @ VDD=5 V**

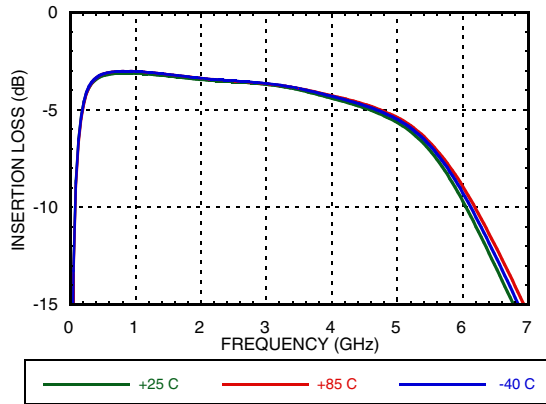

**Attenuation vs. Frequency Over Vctrl @ VDD=5 V**

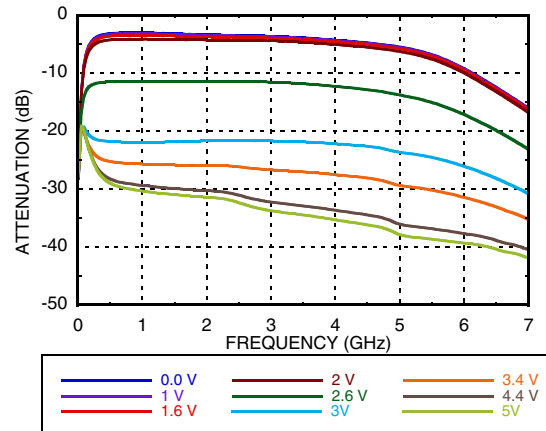

**Attenuation vs. Vctrl Over Temperature @ 0.5 GHz and VDD=5 V**

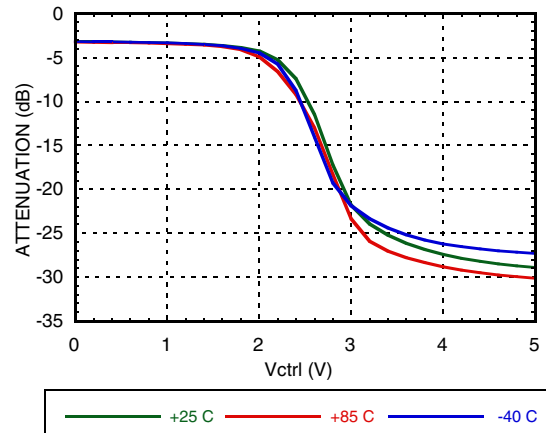

**Attenuation vs. Vctrl Over Temperature @ 2 GHz and VDD=5 V**

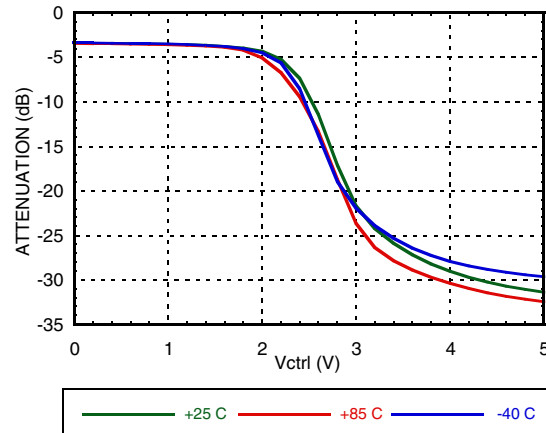

**Attenuation vs. Vctrl Over Temperature @ 4 GHz and VDD=5 V**

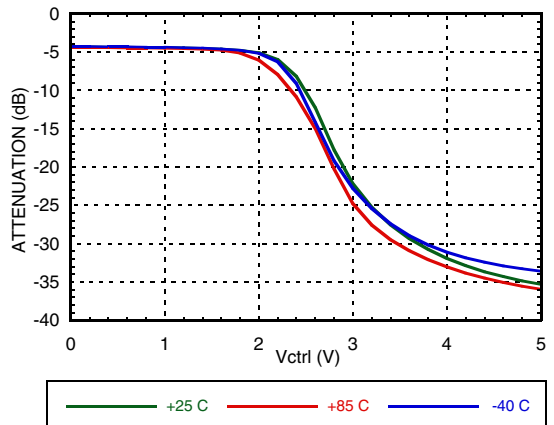

**Attenuation vs. Vctrl Over Temperature @ 5 GHz and VDD=5 V**

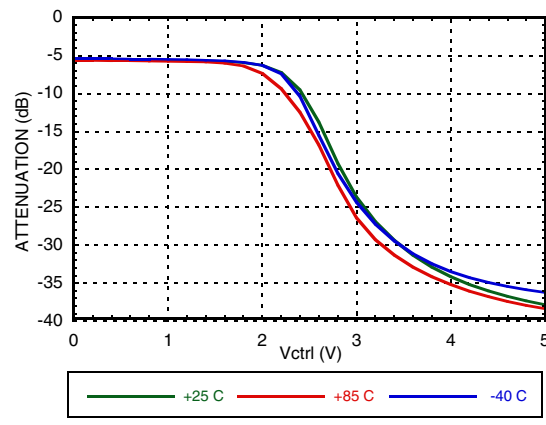

**GAAS MMIC VOLTAGE VARIABLE ATTENUATOR, 0.5 - 5.0 GHz**

**Input Return Loss Over Temperature (Vctrl = 0) @ VDD=5 V**

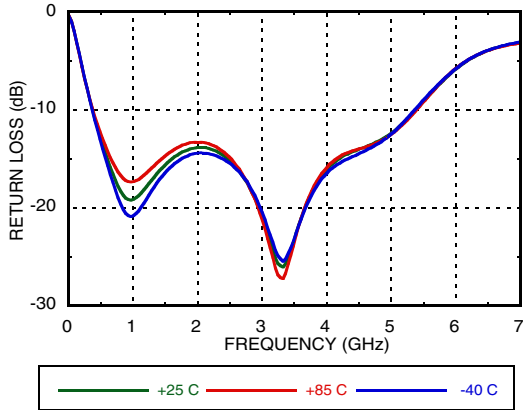

**Input Return Loss Over Vctrl @ VDD=5 V**

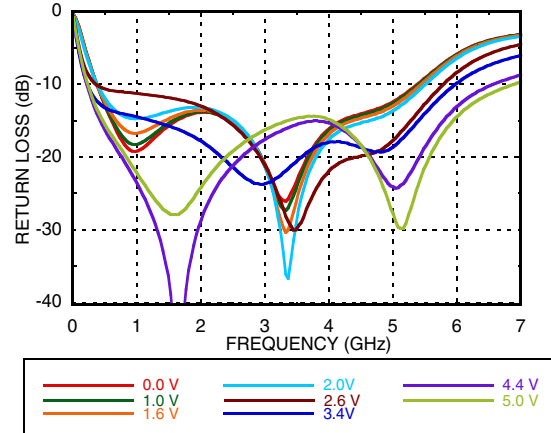

**Output Return Loss Over Temperature (Vctrl = 0) @ VDD=5 V**

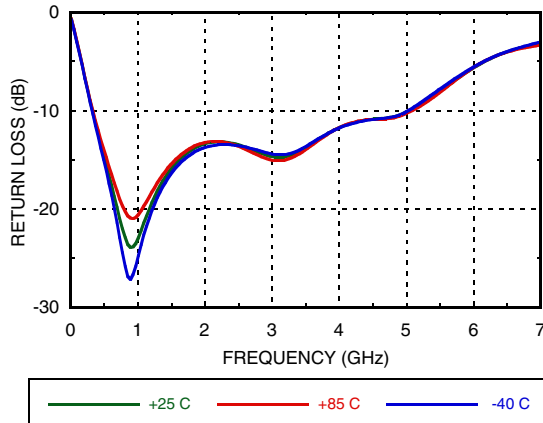

**Output Return Loss Over Vctrl @ VDD=5 V**

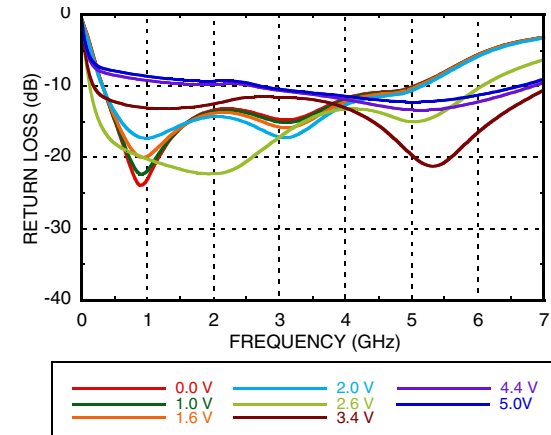

**Input IP3 Vs Frequency Over Vctrl @ VDD=5 V**

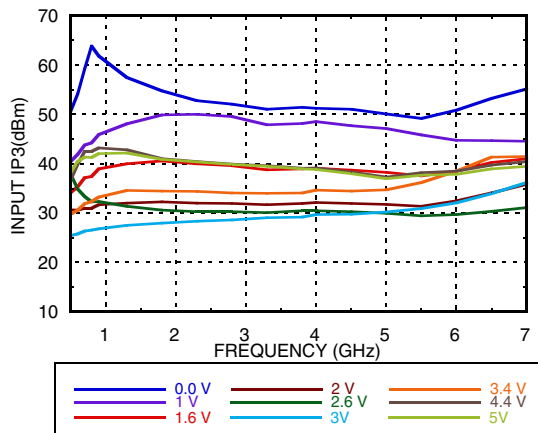

**Input IP3 Over Temperature (Vctrl = 0V) @ VDD=5 V**

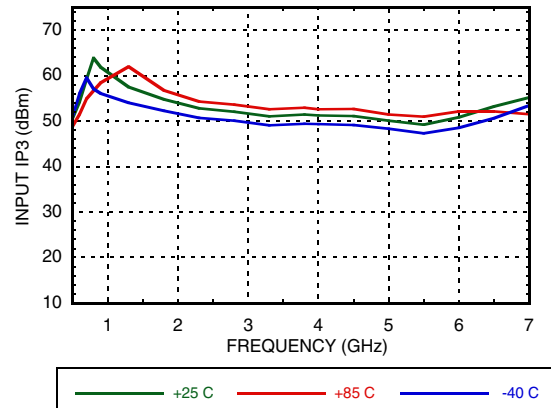

**GAAS MMIC VOLTAGE VARIABLE ATTENUATOR, 0.5 - 5.0 GHz**

**Insertion Loss vs. Frequency Over Temperature @ 3 V**

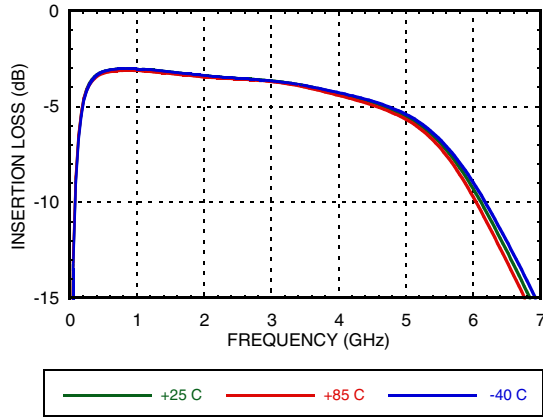

**Attenuation vs. Frequency Over Vctrl @ 3 V**

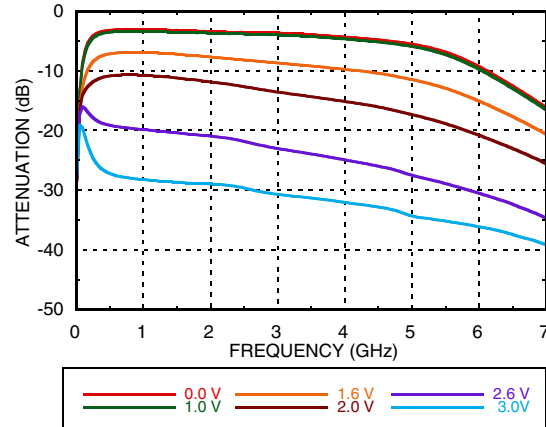

**Attenuation vs. Vctrl Over Temperature @ 0.5 GHz and 3 V**

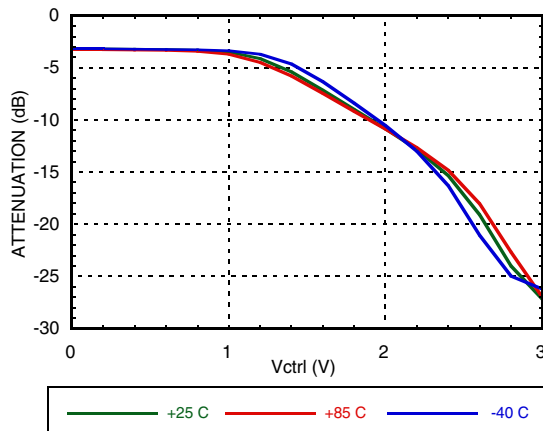

**Attenuation vs. Vctrl Over Temperature @ 2 GHz and 3 V**

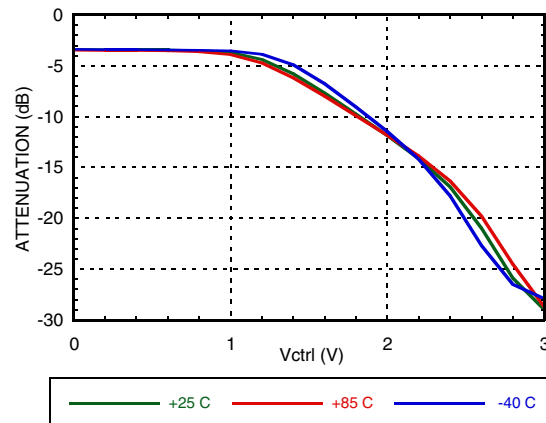

**Attenuation vs. Vctrl Over Temperature @ 4 GHz and 3 V**

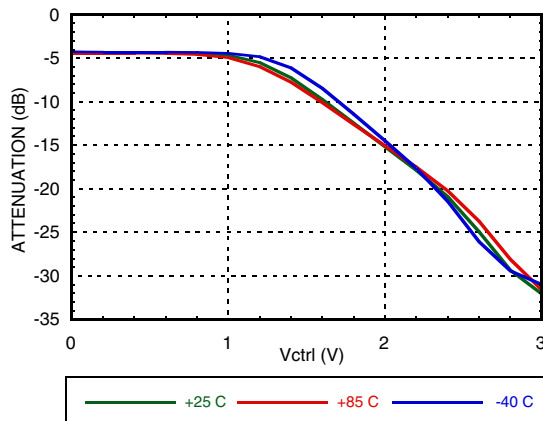

**Attenuation vs. Vctrl Over Temperature @ 5 GHz and 3 V**

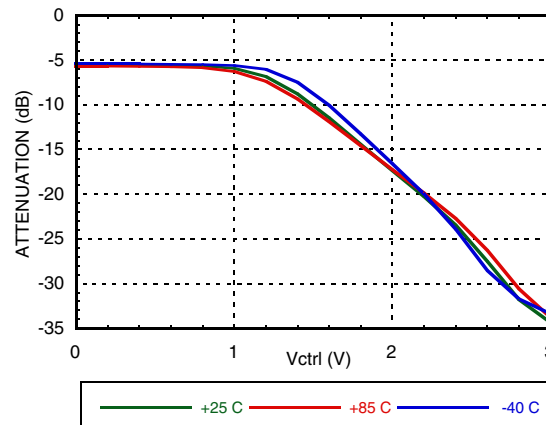

**GAAS MMIC VOLTAGE VARIABLE ATTENUATOR, 0.5 - 5.0 GHz**

**Input Return Loss Over Temperature (Vctrl = 0) @ VDD=3 V**

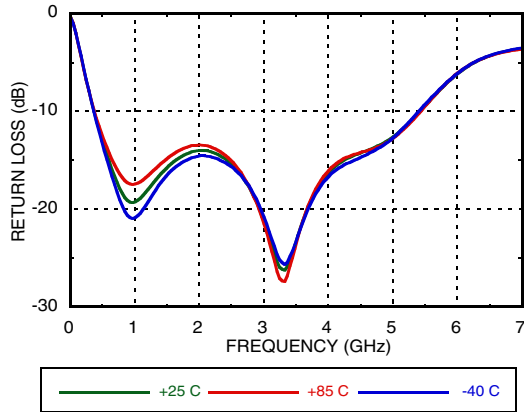

**Input Return Loss Over Vctrl @ VDD=3 V**

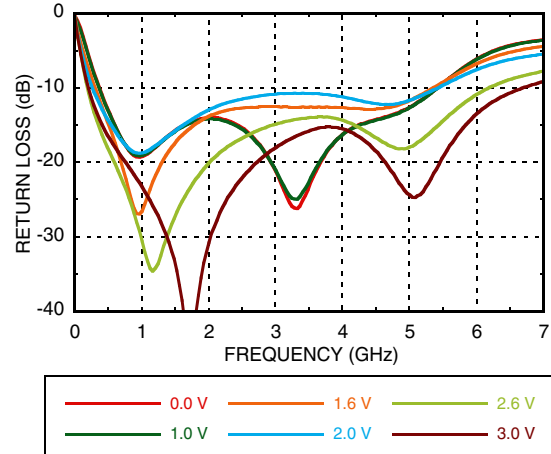

**Output Return Loss Over Temperature (Vctrl = 0) @ VDD=3 V**

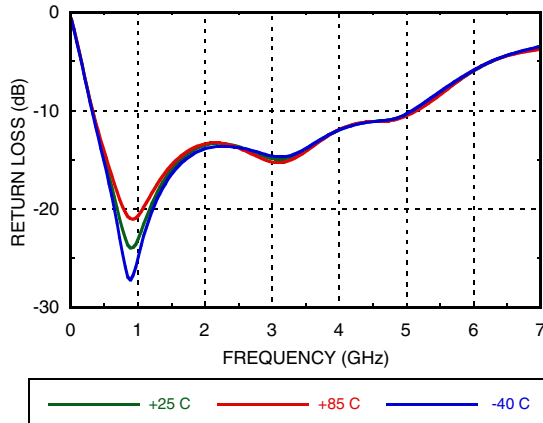

**Output Return Loss Over Vctrl @ VDD=3 V**

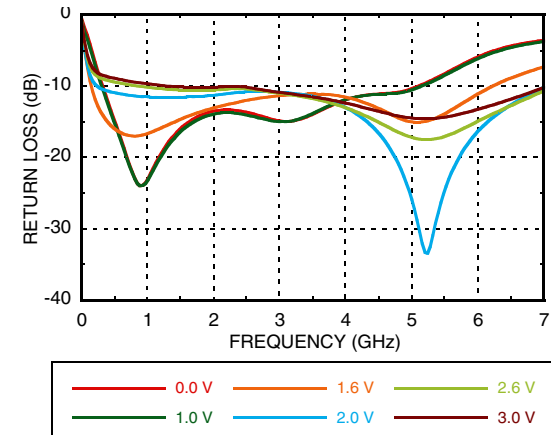

**Input IP3 Vs Frequency Over Vctrl @ VDD=3 V**

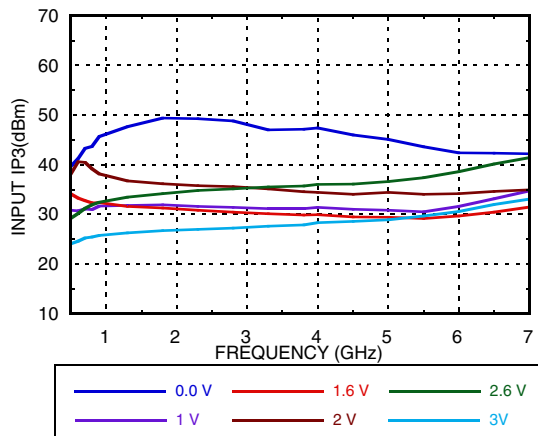

**Input IP3 Over Temperature (Vctrl = 0V) @ VDD=3 V**

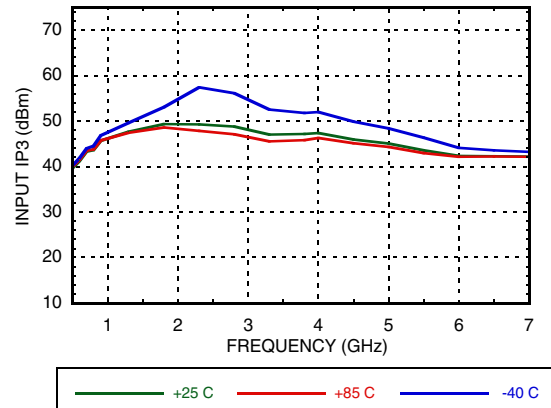

## GAAS MMIC VOLTAGE VARIABLE ATTENUATOR, 0.5 - 5.0 GHz

### Absolute Maximum Ratings

RF Input Power	+29 dBm
Vdd	5.5V
Control Voltage Range	-0.5V to Vdd
Channel Temperature	150 °C
Continuous Pdiss (T = 85 °C)	0.8W
Thermal Resistance (Channel to ground paddle)	35 C/W
Storage Temperature	-65 to +150 °C
Operating Temperature	-40 to +85 °C
ESD Sensitivity (HBM)	Class 1A

### Voltages & Currents

Vdd	5V @ 600 μA
Vctrl	0 to +5V @ 2.6mA



ELECTROSTATIC SENSITIVE DEVICE  
OBSERVE HANDLING PRECAUTIONS

### Outline Drawing

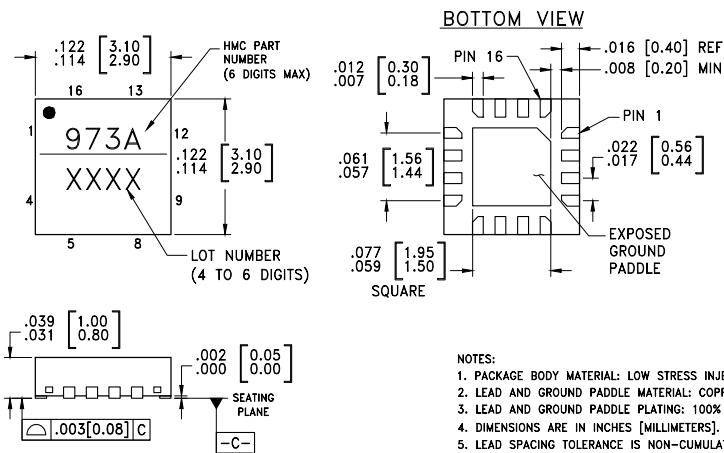

#### NOTES:

1. PACKAGE BODY MATERIAL: LOW STRESS INJECTION MOLDED PLASTIC SILICA AND SILICON IMPREGNATED.
2. LEAD AND GROUND PADDLE MATERIAL: COPPER ALLOY.
3. LEAD AND GROUND PADDLE PLATING: 100% MATTE TIN.
4. DIMENSIONS ARE IN INCHES [MILLIMETERS].
5. LEAD SPACING TOLERANCE IS NON-CUMULATIVE.
6. CHARACTERS TO BE HELVETICA MEDIUM, .018 HIGH, WHITE INK, OR LASER MARK LOCATED APPROX. AS SHOWN.
7. PAD BURR LENGTH SHALL BE 0.15mm MAX. PAD BURR HEIGHT SHALL BE 0.05mm MAX.
8. PACKAGE WARP SHALL NOT EXCEED 0.05mm
9. ALL GROUND LEADS AND GROUND PADDLE MUST BE SOLDERED TO PCB RF GROUND.
10. REFER TO ADI APPLICATION NOTE FOR SUGGESTED PCB LAND PATTERN.

### Package Information

Part Number	Package Body Material	Lead Finish	MSL Rating	Package Marking <sup>[1]</sup>
HMC973ALP3E	RoHS-compliant Low Stress Injection Molded Plastic	100% matte Sn	MSL3 <sup>[2]</sup>	973A XXXX

[1] 4-Digit lot number XXXX

[2] Max peak reflow temperature of 260 °C

## GAAS MMIC VOLTAGE VARIABLE ATTENUATOR, 0.5 - 5.0 GHz

### Pin Descriptions

Pin Number	Function	Description	Interface Schematic
GND Paddle	GND	The exposed ground paddle must be connected to RF/DC ground.	
3	RFOUT	This pin is DC coupled and matched to 50 Ohms. A blocking capacitor is required if RF line potential is not equal to 0V.	
5	Vdd	Supply Voltage	
1,2,4,6, 8, 9, 11- 16	N/C	The pins are not connected internally; however, all data shown herein was measured with these pins connected to RF/DC ground externally.	
7	Vctrl	Control Voltage	
10	RFIN	This pin is DC coupled and matched to 50 Ohms. A blocking capacitor is required if RF line potential is not equal to 0V. The HMC973ALP3E is a unidirectional device with optimum linearity performance achieved with RF input signal applied to RFIN package lead.	

### Application Circuit

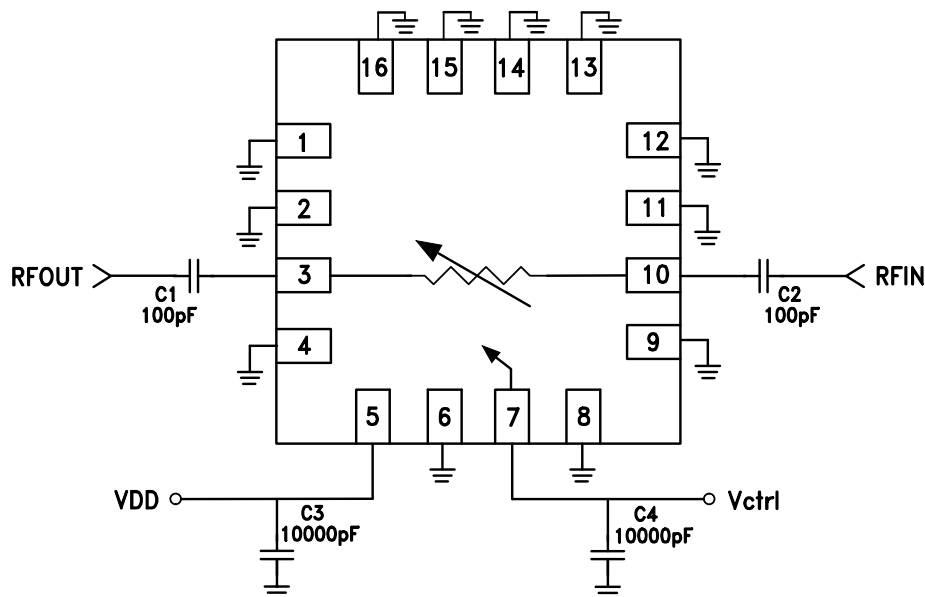

**GAAS MMIC VOLTAGE VARIABLE  
ATTENUATOR, 0.5 - 5.0 GHz**

**Evaluation PCB**

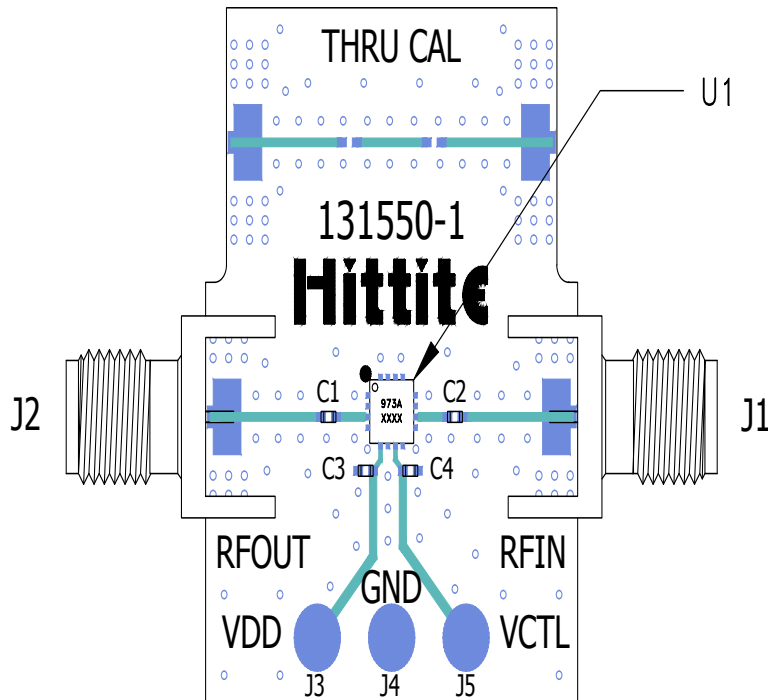

**List of Materials for Evaluation PCB EV1HMC973ALP3 [1]**

Item	Description
J1, J2	PCB Mount SMA RF Connector
J3 - J5	DC Pin
C1, C2	100 pF Capacitor, 0402 Pkg.
C3, C4	10000 pF Capacitor, 0402 Pkg.
U1	HMC973ALP3E Voltage Variable Attenuator
PCB [2]	131550 Evaluation PCB

[1] Reference this number when ordering complete evaluation PCB

[2] Circuit Board Material: Arlon 25FR or Rogers 4350

The circuit board used in the application should use RF circuit design techniques. Signal lines should have 50 Ohm impedance while the package ground leads and exposed paddle should be connected directly to the ground plane similar to that shown. A sufficient number of via holes should be used to connect the top and bottom ground planes. The evaluation circuit board shown is available from Analog Devices upon request.



## Данный компонент на территории Российской Федерации

### Вы можете приобрести в компании MosChip.

Для оперативного оформления запроса Вам необходимо перейти по данной ссылке:

<http://moschip.ru/get-element>

Вы можете разместить у нас заказ для любого Вашего проекта, будь то серийное производство или разработка единичного прибора.

В нашем ассортименте представлены ведущие мировые производители активных и пассивных электронных компонентов.

Нашей специализацией является поставка электронной компонентной базы двойного назначения, продукции таких производителей как XILINX, Intel (ex.ALTERA), Vicor, Microchip, Texas Instruments, Analog Devices, Mini-Circuits, Amphenol, Glenair.

Сотрудничество с глобальными дистрибьюторами электронных компонентов, предоставляет возможность заказывать и получать с международных складов практически любой перечень компонентов в оптимальные для Вас сроки.

На всех этапах разработки и производства наши партнеры могут получить квалифицированную поддержку опытных инженеров.

Система менеджмента качества компании отвечает требованиям в соответствии с ГОСТ Р ИСО 9001, ГОСТ РВ 0015-002 и ЭС РД 009

### Офис по работе с юридическими лицами:

105318, г.Москва, ул.Щербаковская д.3, офис 1107, 1118, ДЦ «Щербаковский»

Телефон: +7 495 668-12-70 (многоканальный)

Факс: +7 495 668-12-70 (доб.304)

E-mail: [info@moschip.ru](mailto:info@moschip.ru)

Skype отдела продаж:

moschip.ru

moschip.ru\_4

moschip.ru\_6

moschip.ru\_9