

Analog Devices Welcomes Hittite Microwave Corporation

NO CONTENT ON THE ATTACHED DOCUMENT HAS CHANGED



THIS PAGE INTENTIONALLY LEFT BLANK

Typical Applications

The HMC374 / HMC374E is ideal for:

- Cellular/PCS/3G
- WCS, MMDS & ISM
- Fixed Wireless & WLAN
- Private Land Mobile Radio

Features

- Single Supply: Vdd = +2.75 to +5.5V
- Low Noise Figure: 1.5 dB
- High Output IP3: +37 dBm
- No External Matching Required

Functional Diagram

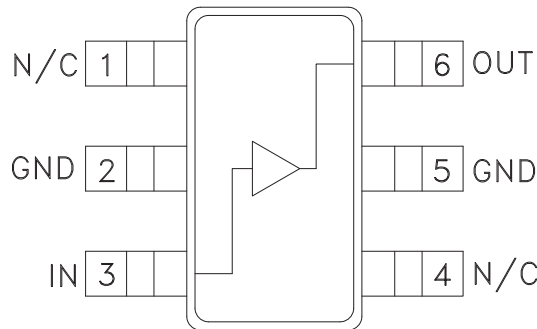

General Description

The HMC374 & HMC374E are general purpose broad band Low Noise Amplifiers (LNA) for use in the 0.3 - 3 GHz frequency range. The LNA provides 15 dB of gain and a 1.5 dB noise figure from a single positive supply of +2.75 to +5.5V. The low noise figure coupled with a high P1dB (22 dBm) and high OIP3 (37 dBm) make this part ideal for cellular applications. The compact LNA design utilizes on-chip matching for repeatable gain and noise figure performance. To minimize board area the design is offered in a low cost SOT26 package that occupies only 0.118" x 0.118".

Electrical Specifications, $T_A = +25^\circ\text{C}$, Vdd = +5V

Parameter	Min.	Typ.	Max.	Min.	Typ.	Max.	Min.	Typ.	Max.	Units
Frequency Range	0.3 - 1.0			1.0 - 2.0			2.0 - 3.0			GHz
Gain	12	15		10	13		6	9		dB
Gain Variation Over Temperature		0.01	0.02		0.01	0.02		0.01	0.02	dB/°C
Noise Figure		1.5	1.9		1.6	2.0		1.8	2.2	dB
Input Return Loss		5			8			13		dB
Output Return Loss		7			9			9		dB
Output 1 dB Compression (P1dB)		22			22			22		dBm
Saturated Output Power (Psat)		23			23			23		dBm
Output Third Order Intercept (IP3)		37			37			37		dBm
Supply Current (Idd) (Vdd = +5V)		90			90			90		mA

Broadband Gain & Return Loss

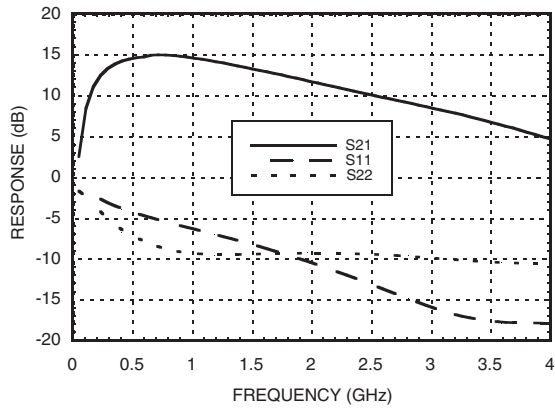

Gain vs. Temperature

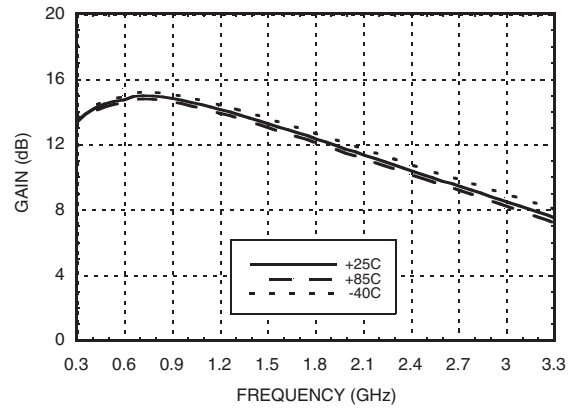

Input Return Loss vs. Temperature

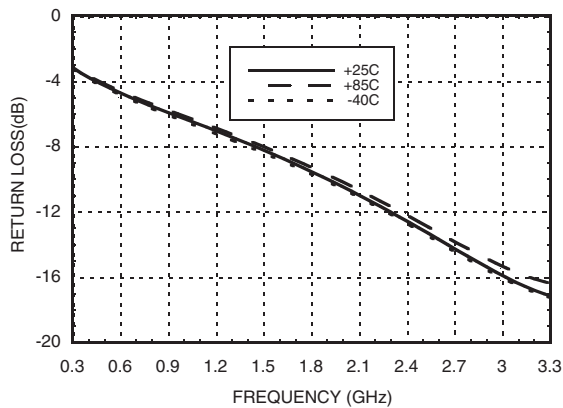

Output Return Loss vs. Temperature

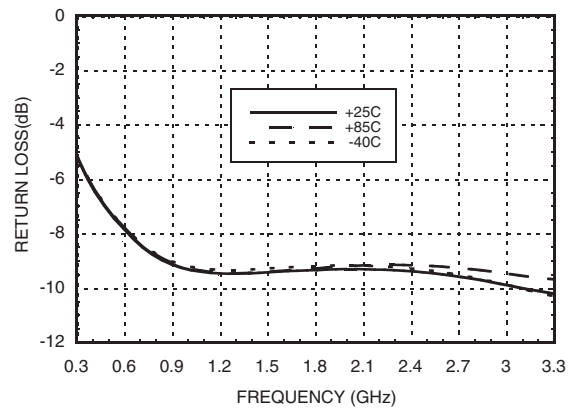

Noise Figure vs. Temperature

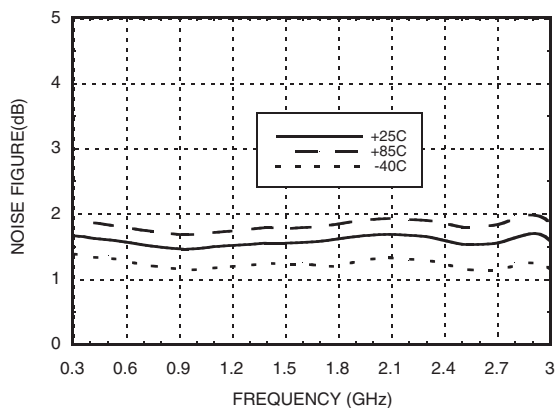

Output IP3 vs. Temperature

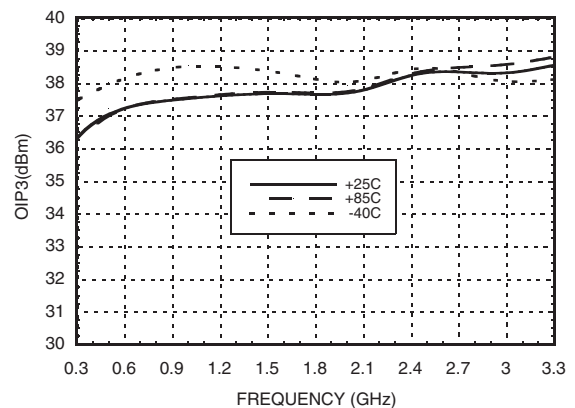

P1dB vs. Temperature

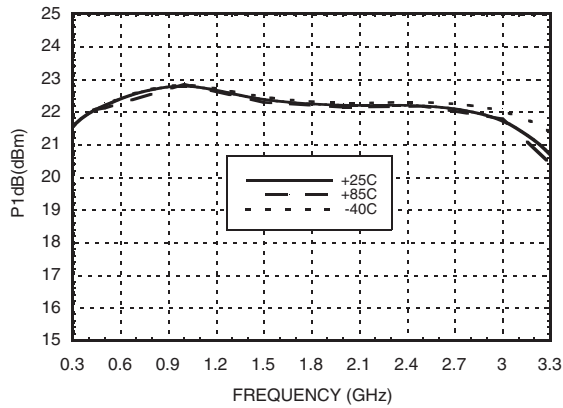

Psat vs. Temperature

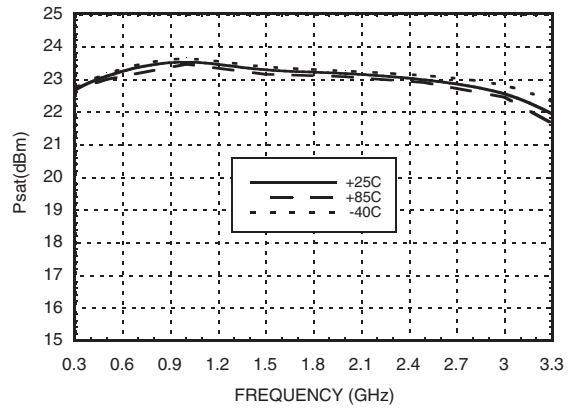

Reverse Isolation vs. Temperature

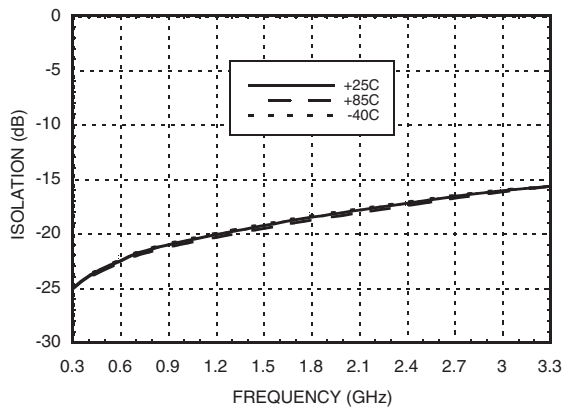

Power Compression @ 2 GHz

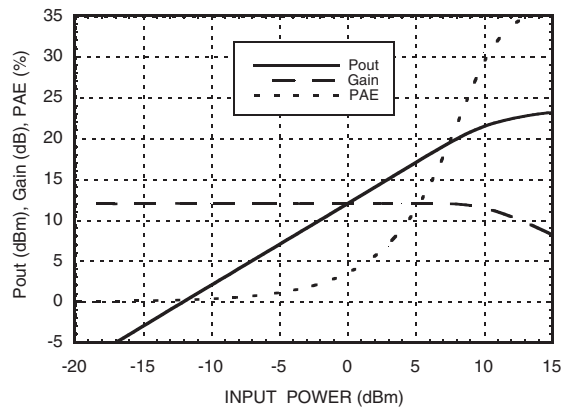

Gain, Noise Figure & Power vs. Supply Voltage @ 2 GHz

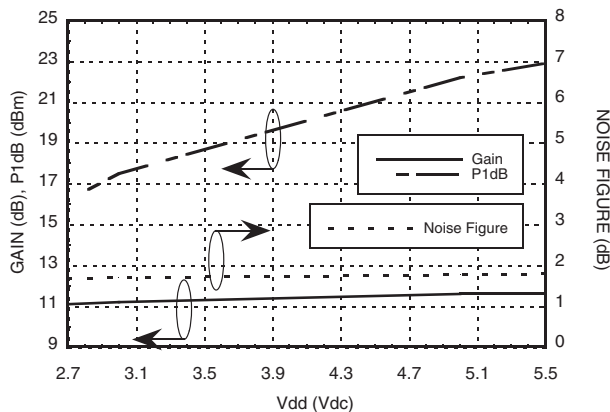

Current vs. Power @ 2 GHz

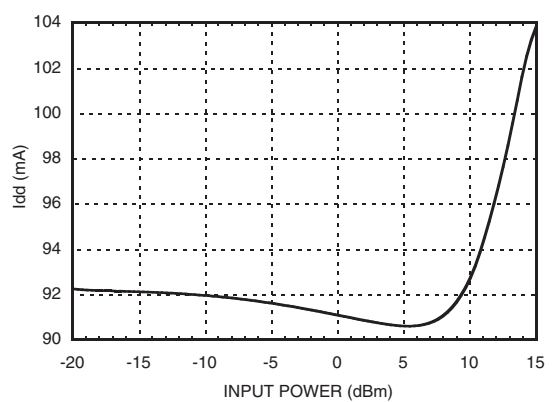

Absolute Maximum Ratings

Drain Bias Voltage (Vdd)	+7.0 Vdc
RF Input Power (RFIN)(Vdd = +5.0 Vdc)	15 dBm
Channel Temperature	150 °C
Continuous Pdiss (T = 85 °C) (derate 7.5 mW/°C above 85 °C)	0.488 W
Thermal Resistance (channel to lead)	133 °C/W
Storage Temperature	-65 to +150 °C
Operating Temperature	-40 to +85 °C

Typical Supply Current vs. Vdd

Vdd (V)	Idd (mA)
2.7	89
3.0	89
5.0	90
5.5	90



ELECTROSTATIC SENSITIVE DEVICE
OBSERVE HANDLING PRECAUTIONS

Outline Drawing

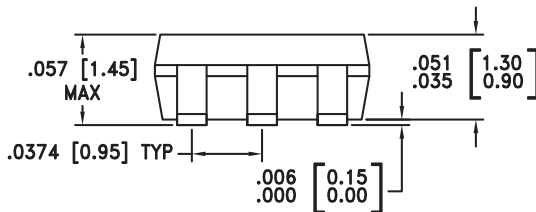
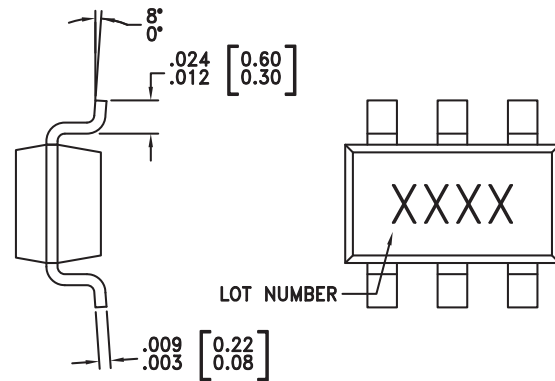
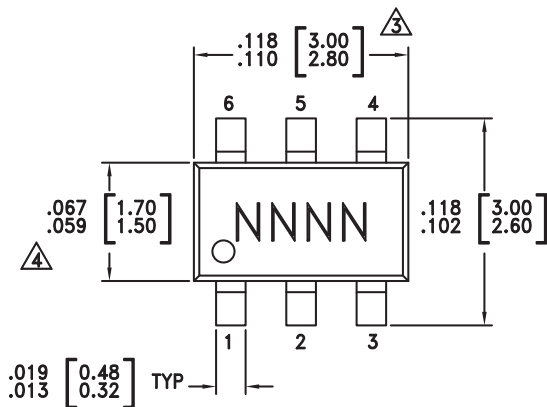

NOTES:

1. LEADFRAME MATERIAL: COPPER ALLOY
2. DIMENSIONS ARE IN INCHES [MILLIMETERS]
3. DIMENSION DOES NOT INCLUDE MOLDFLASH OF 0.15mm PER SIDE.
4. DIMENSION DOES NOT INCLUDE MOLDFLASH OF 0.25mm PER SIDE.
5. ALL GROUND LEADS MUST BE SOLDERED TO PCB RF GROUND.

Package Information

Part Number	Package Body Material	Lead Finish	MSL Rating	Package Marking ^[3]
HMC374	Low Stress Injection Molded Plastic	Sn/Pb Solder	MSL1 ^[1]	H374 XXXX
HMC374E	RoHS-compliant Low Stress Injection Molded Plastic	100% matte Sn	MSL1 ^[2]	374E XXXX

[1] Max peak reflow temperature of 235 °C

[2] Max peak reflow temperature of 260 °C

[3] 4-Digit lot number XXXX

Pin Descriptions

Pin Number	Function	Description	Interface Schematic
1,4	N/C	These pins may be connected to RF/DC ground. Performance will not be affected.	
2, 5	GND	These pins must be connected to RF/DC ground.	
3	IN	This pin is DC coupled. An off-chip DC blocking capacitor is required.	
6	OUT	RF output and DC Bias for the output stage. See application circuit for off-chip components.	

Application Circuit

Recommended Component Values	
C1, C2	150 pF
C3	1,000 pF
C4	4.7 μ F
L1	27 nH

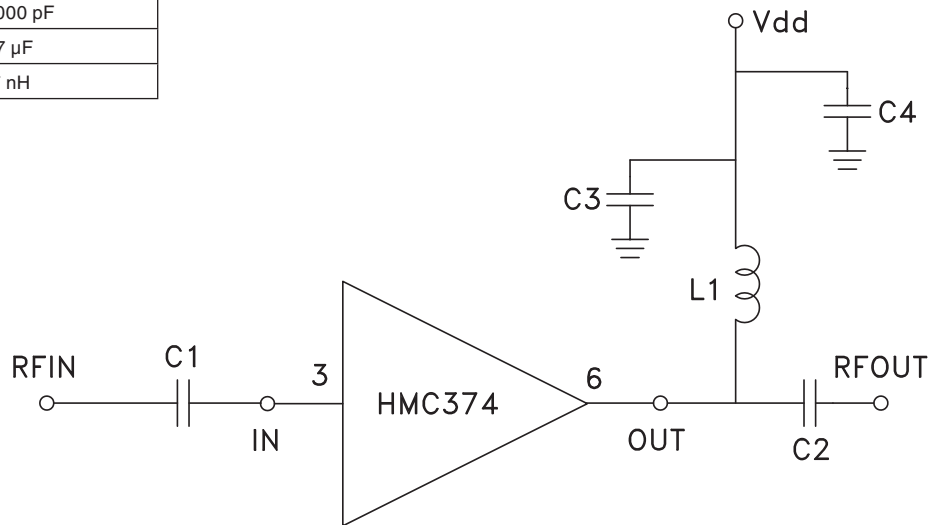

Evaluation PCB

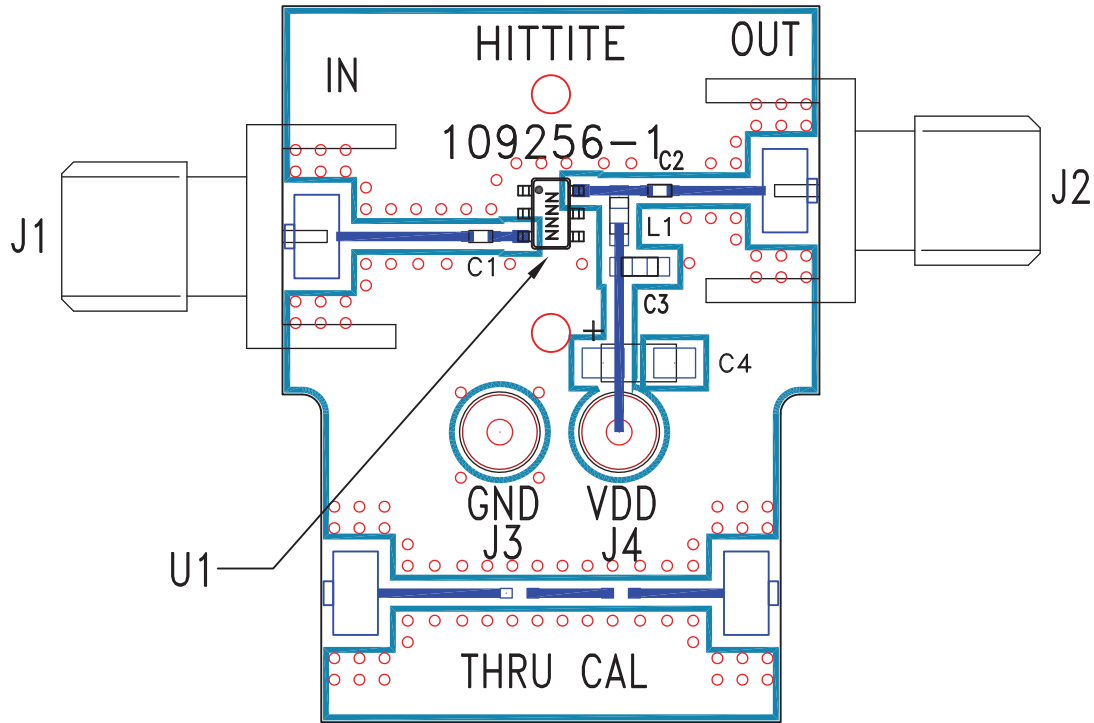

List of Materials for Evaluation PCB 109258 [1]

Item	Description
J1, J2	PCB Mount SMA Connector
J3, J4	DC Pin
C1, C2	150 pF Capacitor, 0402 Pkg.
C3	1000 pF Capacitor, 0603 Pkg.
C4	4.7 Capacitor, Tantalum
L1	27 nH Inductor, 0603 Pkg.
U1	HMC374 / HMC374E Amplifier
PCB [2]	109256 Evaluation PCB

[1] Reference this number when ordering complete evaluation PCB

[2] Circuit Board Material: Roger 4350

The circuit board used in the final application should use RF circuit design techniques. Signal lines should have 50 ohm impedance while the package ground leads should be connected directly to the ground plane similar to that shown above. A sufficient number of via holes should be used to connect the top and bottom ground planes. The evaluation circuit board shown is available from Hittite upon request.

Данный компонент на территории Российской Федерации

Вы можете приобрести в компании MosChip.

Для оперативного оформления запроса Вам необходимо перейти по данной ссылке:

<http://moschip.ru/get-element>

Вы можете разместить у нас заказ для любого Вашего проекта, будь то серийное производство или разработка единичного прибора.

В нашем ассортименте представлены ведущие мировые производители активных и пассивных электронных компонентов.

Нашей специализацией является поставка электронной компонентной базы двойного назначения, продукции таких производителей как XILINX, Intel (ex.ALTERA), Vicor, Microchip, Texas Instruments, Analog Devices, Mini-Circuits, Amphenol, Glenair.

Сотрудничество с глобальными дистрибьюторами электронных компонентов, предоставляет возможность заказывать и получать с международных складов практически любой перечень компонентов в оптимальные для Вас сроки.

На всех этапах разработки и производства наши партнеры могут получить квалифицированную поддержку опытных инженеров.

Система менеджмента качества компании отвечает требованиям в соответствии с ГОСТ Р ИСО 9001, ГОСТ РВ 0015-002 и ЭС РД 009

Офис по работе с юридическими лицами:

105318, г.Москва, ул.Щербаковская д.3, офис 1107, 1118, ДЦ «Щербаковский»

Телефон: +7 495 668-12-70 (многоканальный)

Факс: +7 495 668-12-70 (доб.304)

E-mail: info@moschip.ru

Skype отдела продаж:

moschip.ru

moschip.ru_4

moschip.ru_6

moschip.ru_9