



- RF Filter for Mobile Communication Applications
- No Matching Circuit Required
- 3.0 x 3.0 x 1.3 mm Package
- Complies with Directive 2002/95/EC (RoHS)



**Absolute Maximum Ratings**

Rating	Value	Units
Maximum Input Power	+10	dBm
DC Voltage on any Non-ground Terminal	0	VDC
Storage Temperature Range in Tape and Reel	-40 to +85	°C
Maximum Soldering Profile, 5 cycles/10 seconds maximum	265	°C

**SF2001E**

**1960 MHz  
SAW Filter**

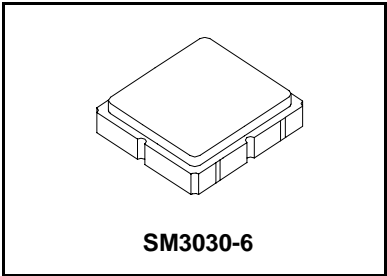

**Electrical Characteristics**

Characteristic	Sym	Notes	Min	Typ	Max	Units
Nominal Operating Frequency	$f_c$			1960		MHz
Passband Insertion Loss, 1930 -1990 MHz	IL			2.35	4.0	dB
Amplitude Ripple, 1930 -1990 MHz				1.4	2.4	dB <sub>P-P</sub>
Attenuation Referenced to 0 dB						
DC to 1850 MHz			20.0	32.0		dB
1850 to 1910 MHz			10.0	21.0		dB
2010 to 2040 MHz			4.5	10.0		dB
2040 to 2070 MHz			20.0	50		dB
2070 to 5000 MHz			22.0	29.0		dB
5000 to 6000 MHz			10.0	15.0		dB
VSWR, 1930 to 1990 MHz				1.7	2.4	
Source impedance	$Z_S$			50		$\Omega$
Load impedance	$Z_L$			50		$\Omega$
Operating Temperature	$T_A$		-30		+80	°C

Case Style	SM3030-6 3 x 3 mm Nominal Footprint
Lid Symbolization (Y=year, WW=week S=shift)	652 YWWS

**Electrical Connections**

Connection	Terminals
Input	2
Output	5
Ground	All others



**CAUTION: Electrostatic Sensitive Device. Observe precautions for handling.**

**Notes:**

1. Unless noted otherwise, all specifications apply over the operating temperature range with filter soldered to the specified demonstration board with impedance matching to 50  $\Omega$  and measured with 50  $\Omega$  network analyzer.
2. Unless noted otherwise, all frequency specifications are referenced to the nominal center frequency,  $f_c$ .
3. Rejection is measured as attenuation below the minimum IL point in the passband. Rejection in final user application is dependent on PCB layout and external impedance matching design. See Application Note No. 42 for details.
4. "LRIP" or "L" after the part number indicates "low rate initial production" and "ENG" or "E" indicates "engineering prototypes."
5. The design, manufacturing process, and specifications of this filter are subject to change.
6. Either Port 1 or Port 2 may be used for either input or output in the design. However, impedances and impedance matching may vary between Port 1 and Port 2, so that the filter must always be installed in one direction per the circuit design.
7. US and international patents may apply.
8. RFM, stylized RFM logo, and RF Monolithics, Inc. are registered trademarks of RF Monolithics, Inc.

Frequency Characteristics:

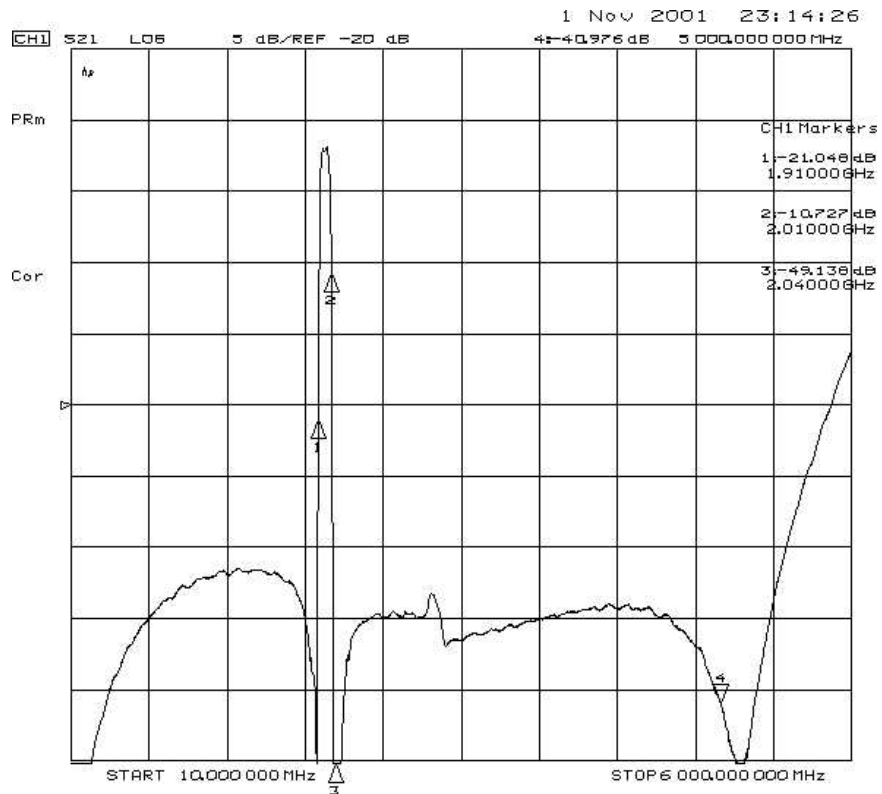
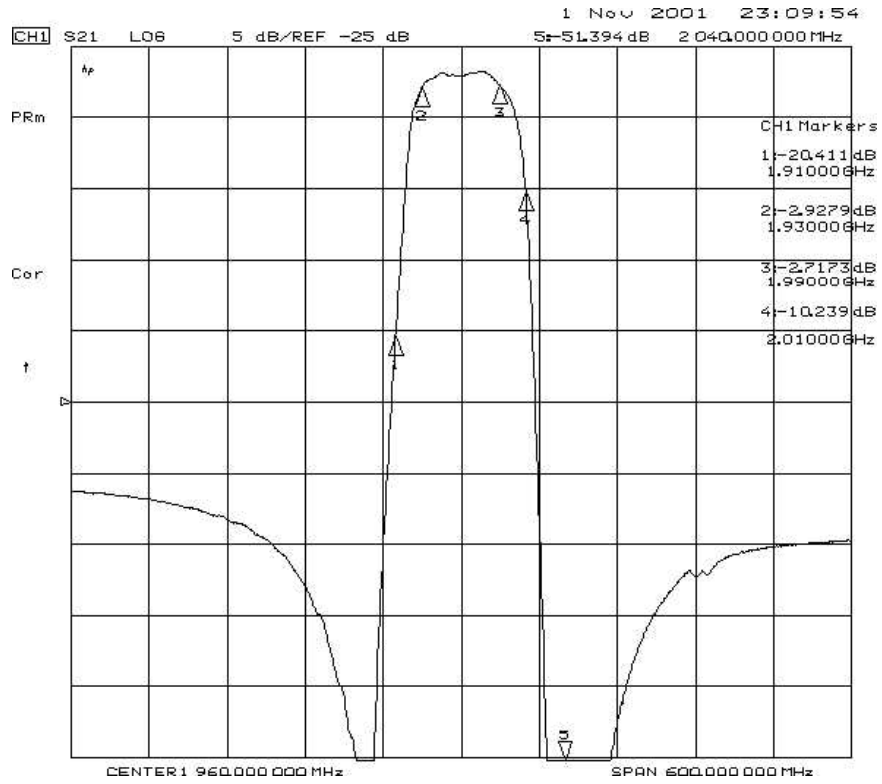

Reflections Functions:

S11 VSWR

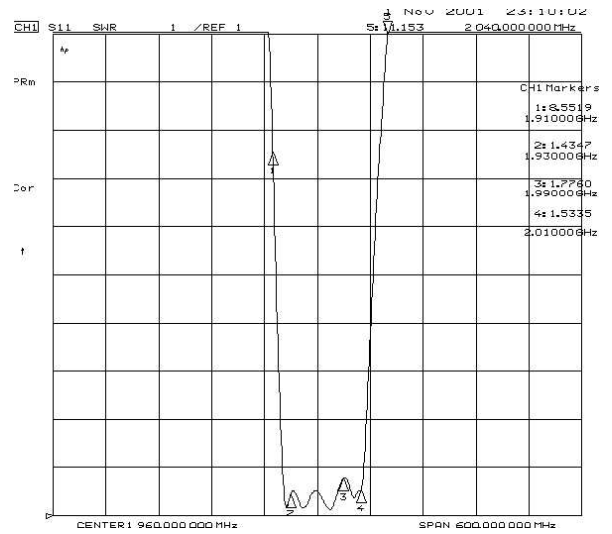
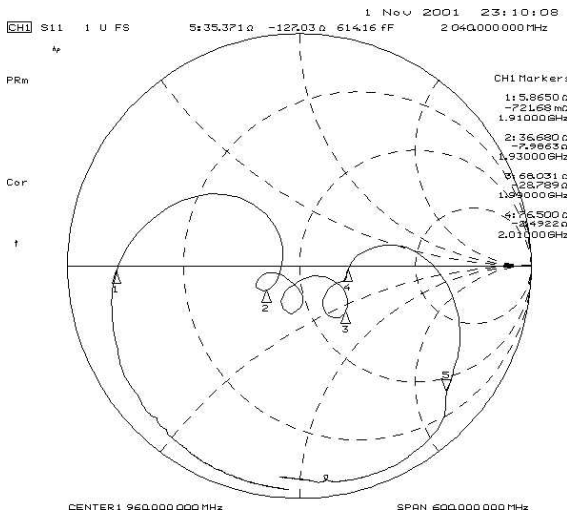

S22 VSWR

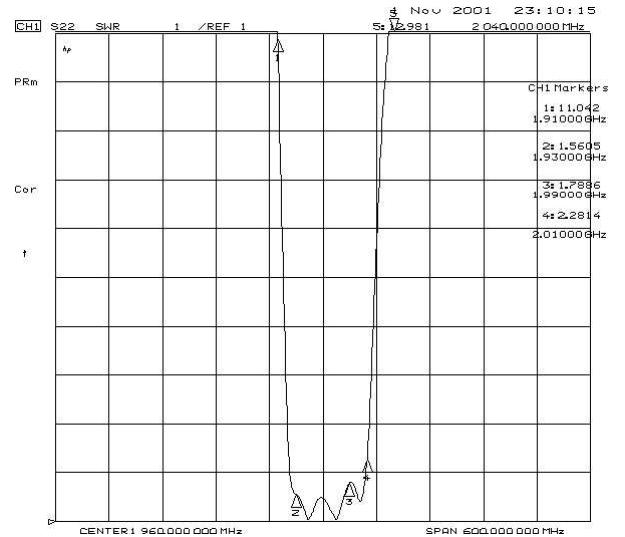
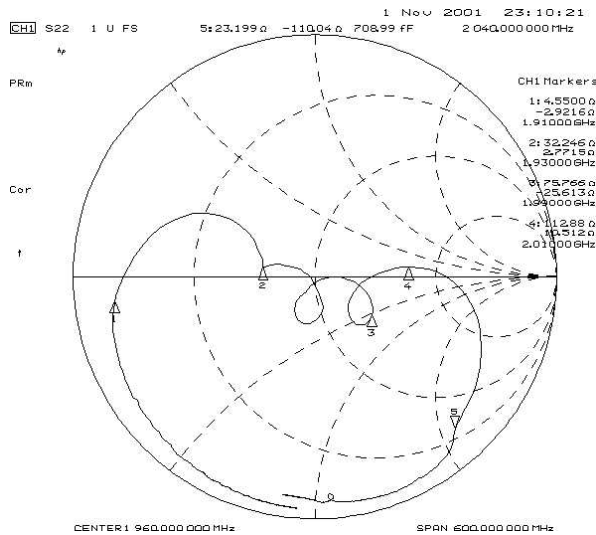

# SM3030-6 Case

## 6-Terminal Ceramic Surface-Mount Case 3.0 X 3.0 mm Nominal Footprint

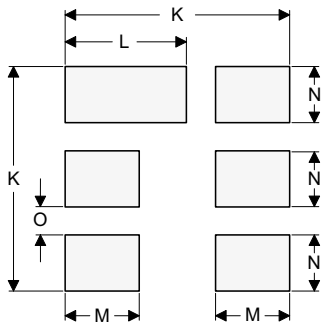
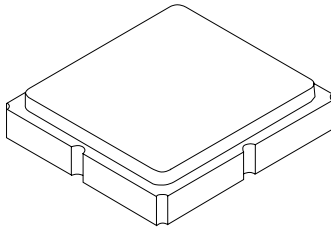

PCB Footprint Top View

### Case and PCB Footprint Dimensions

Dimension	mm			Inches		
	Min	Nom	Max	Min	Nom	Max
A	2.87	3.00	3.13	0.113	0.118	0.123
B	2.87	3.00	3.13	0.113	0.118	0.123
C	1.12	1.25	1.38	0.044	0.049	0.054
D	0.77	0.90	1.03	0.030	0.035	0.040
E	2.67	2.80	2.93	0.105	0.110	0.115
F	1.47	1.60	1.73	0.058	0.063	0.068
G	0.72	0.85	0.98	0.028	0.033	0.038
H	1.37	1.50	1.63	0.054	0.059	0.064
I	0.47	0.60	0.73	0.019	0.024	0.029
J	1.17	1.30	1.43	0.046	0.051	0.056
K		3.20			0.126	
L		1.70			0.067	
M		1.05			0.041	
N		0.81			0.032	
O		0.38			0.015	

### Case Materials

Materials	
Solder Pad Plating	0.3 to 1.0 $\mu$ m Gold over 1.27 to 8.89 $\mu$ m Nickel
Lid Plating	2.0 to 3.0 $\mu$ m Nickel
Body	Al <sub>2</sub> O <sub>3</sub> Ceramic
Pb Free	

### Top View

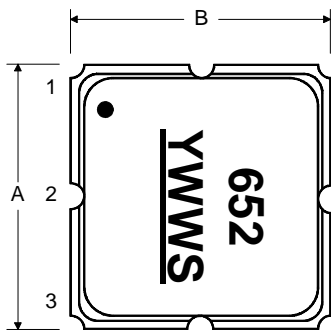

### Bottom View

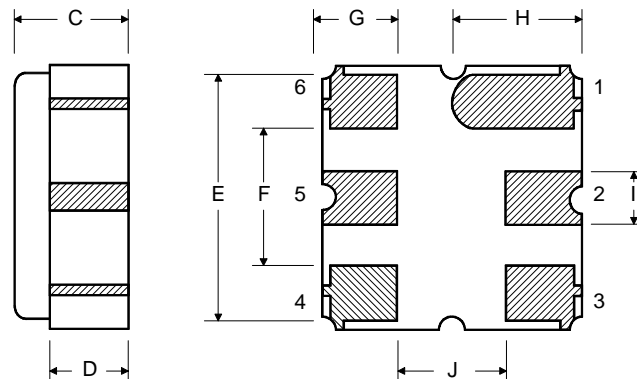

# Tape and Reel Specifications

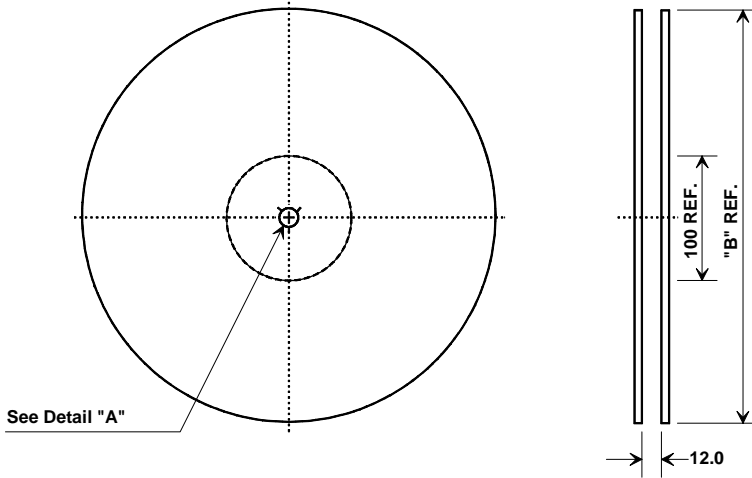

"B"		Quantity Per Reel
Inches	millimeters	
7	178	500
13	330	3000

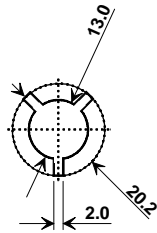

## COMPONENT ORIENTATION

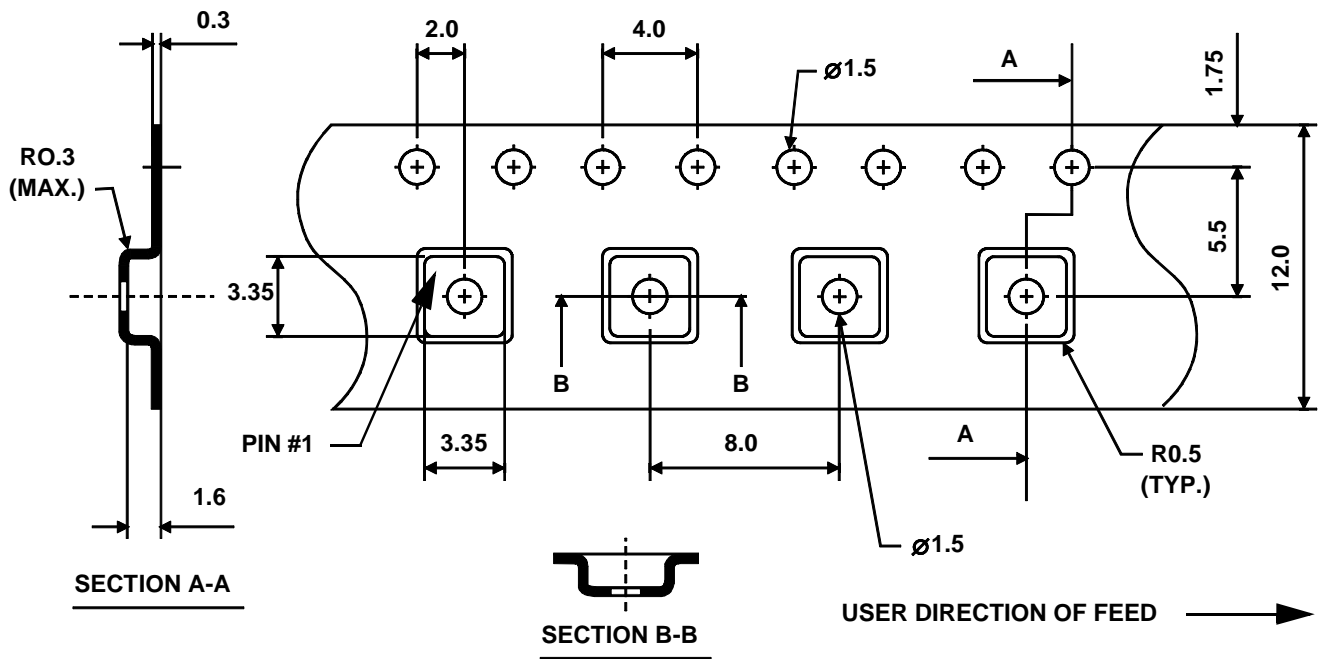

## Данный компонент на территории Российской Федерации

### Вы можете приобрести в компании MosChip.

Для оперативного оформления запроса Вам необходимо перейти по данной ссылке:

<http://moschip.ru/get-element>

Вы можете разместить у нас заказ для любого Вашего проекта, будь то серийное производство или разработка единичного прибора.

В нашем ассортименте представлены ведущие мировые производители активных и пассивных электронных компонентов.

Нашей специализацией является поставка электронной компонентной базы двойного назначения, продукции таких производителей как XILINX, Intel (ex.ALTERA), Vicor, Microchip, Texas Instruments, Analog Devices, Mini-Circuits, Amphenol, Glenair.

Сотрудничество с глобальными дистрибьюторами электронных компонентов, предоставляет возможность заказывать и получать с международных складов практически любой перечень компонентов в оптимальные для Вас сроки.

На всех этапах разработки и производства наши партнеры могут получить квалифицированную поддержку опытных инженеров.

Система менеджмента качества компании отвечает требованиям в соответствии с ГОСТ Р ИСО 9001, ГОСТ РВ 0015-002 и ЭС РД 009

### Офис по работе с юридическими лицами:

105318, г.Москва, ул.Щербаковская д.3, офис 1107, 1118, ДЦ «Щербаковский»

Телефон: +7 495 668-12-70 (многоканальный)

Факс: +7 495 668-12-70 (доб.304)

E-mail: [info@moschip.ru](mailto:info@moschip.ru)

Skype отдела продаж:

moschip.ru

moschip.ru\_4

moschip.ru\_6

moschip.ru\_9