

MIRELLA-50-S-PIN

~15° spot beam

TECHNICAL SPECIFICATIONS:

Dimensions	Ø 49.9 mm
Height	23.9 mm
Fastening	pin
ROHS compliant	yes ⓘ

MATERIAL SPECIFICATIONS:

Component	Type	Material	Colour	Finish	Coating
MIRELLA-50-S-PIN	Reflector	PC	metal		lacquer







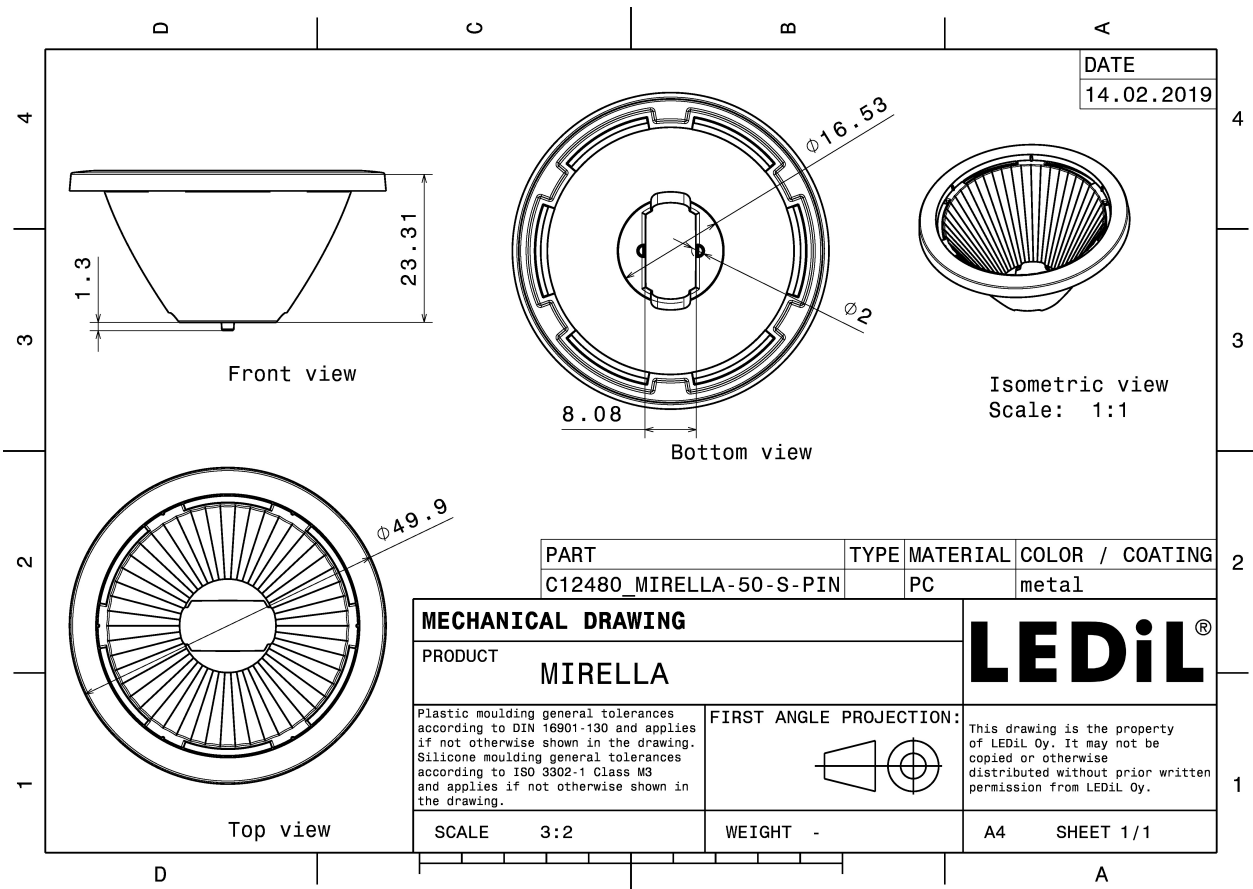

ORDERING INFORMATION:

Component	Qty in box	MOQ	MPQ	Box weight (kg)
C12480_MIRELLA-50-S-PIN » Box size: 480 x 280 x 300 mm	336	112	28	3.0

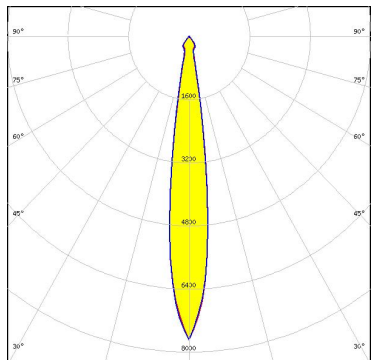

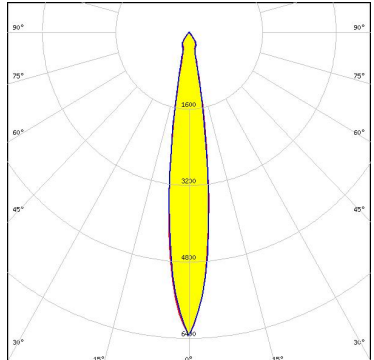
PHOTOMETRIC DATA (MEASURED):

<p>bridgelux.</p> <p>LED SM4 FWHM 15.0° Efficiency 81 % Peak intensity 6.9 cd/lm LEDs/each optic 1 Light colour White Required components: C12479_MIRELLA-DL</p>		
<p>CREE ⇄</p> <p>LED MHB-A/B FWHM 16.0° Efficiency 85 % Peak intensity 7 cd/lm LEDs/each optic 1 Light colour White Required components: C13333_MIRELLA-CL</p>		
<p>CREE ⇄</p> <p>LED MHB-A/B FWHM 17.0° Efficiency 85 % Peak intensity 5.4 cd/lm LEDs/each optic 1 Light colour White Required components: C12479_MIRELLA-DL</p>		
<p>CREE ⇄</p> <p>LED MHB-A/B FWHM 14.0° Efficiency 90 % Peak intensity 9.4 cd/lm LEDs/each optic 1 Light colour White Required components:</p>		

PHOTOMETRIC DATA (MEASURED):

CREE 

LED XHP50
 FWHM 16.0°
 Efficiency 89 %
 Peak intensity 5.3 cd/lm
 LEDs/each optic 1
 Light colour White
 Required components:
 C12479_MIRELLA-DL

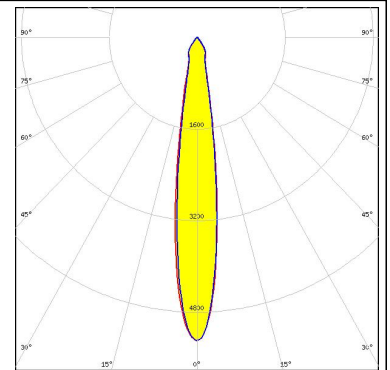

CREE 

LED XHP50
 FWHM 13.0°
 Efficiency 93 %
 Peak intensity 8.8 cd/lm
 LEDs/each optic 1
 Light colour White
 Required components:

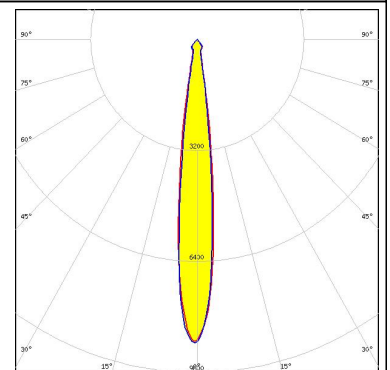

CREE 

LED XHP50
 FWHM 22.0°
 Efficiency 86 %
 Peak intensity 2.8 cd/lm
 LEDs/each optic 1
 Light colour White
 Required components:
 C13723_MIRELLA-RZL

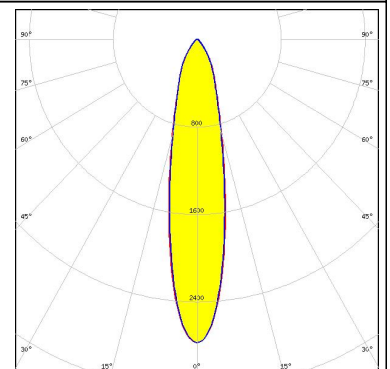
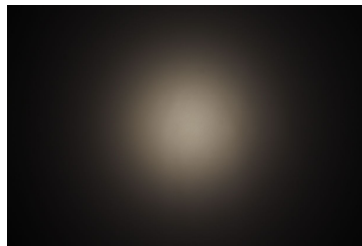

CREE 

LED XHP50
 FWHM 14.0°
 Efficiency 88 %
 Peak intensity 7 cd/lm
 LEDs/each optic 1
 Light colour White
 Required components:
 C13333_MIRELLA-CL

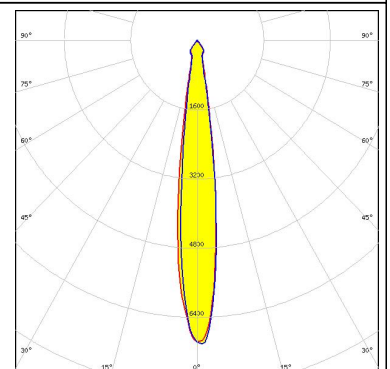

PHOTOMETRIC DATA (MEASURED):

CREE

LED XM-L
FWHM 12.0°
Efficiency 86 %
Peak intensity 8.7 cd/lm
LEDs/each optic 1
Light colour White
Required components:
C12479_MIRELLA-DL



CREE

LED XM-L
FWHM 8.7°
Efficiency 90 %
Peak intensity 19.3 cd/lm
LEDs/each optic 1
Light colour White
Required components:

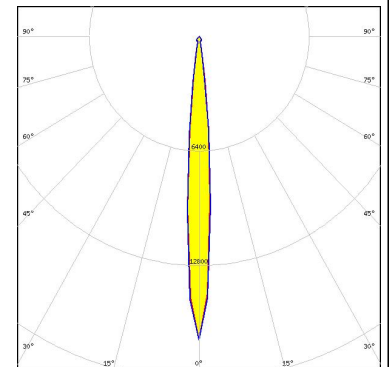

CREE

LED XM-L
FWHM 12.0°
Efficiency 85 %
Peak intensity 11.4 cd/lm
LEDs/each optic 1
Light colour White
Required components:
C13333_MIRELLA-CL



CREE

LED XM-L RGB
FWHM 21.0°
Efficiency 84 %
Peak intensity 3.4 cd/lm
LEDs/each optic 1
Light colour White
Required components:
C13723_MIRELLA-RZL

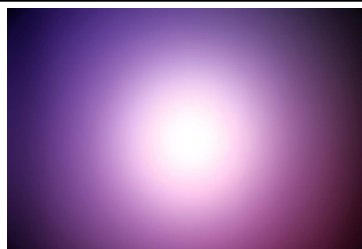

PHOTOMETRIC DATA (MEASURED):

CREE

LED XM-L2
FWHM 12.0°
Efficiency 86 %
Peak intensity 8.2 cd/Im
LEDs/each optic 1
Light colour White
Required components:
C12479_MIRELLA-DL



CREE

LED XM-L2
FWHM 8.6°
Efficiency 91 %
Peak intensity 18.9 cd/Im
LEDs/each optic 1
Light colour White
Required components:



CREE

LED XP-G
FWHM 11.0°
Efficiency 86 %
Peak intensity 10.4 cd/Im
LEDs/each optic 1
Light colour White
Required components:
C12479_MIRELLA-DL



CREE

LED XP-G
FWHM 8.1°
Efficiency 91 %
Peak intensity 25 cd/Im
LEDs/each optic 1
Light colour White
Required components:



PHOTOMETRIC DATA (MEASURED):

CREE

LED XP-G
FWHM 11.0°
Efficiency 86 %
Peak intensity 14.1 cd/Im
LEDs/each optic 1
Light colour White
Required components:
C13333_MIRELLA-CL



CREE

LED XP-G2
FWHM 7.9°
Efficiency 91 %
Peak intensity 25.1 cd/Im
LEDs/each optic 1
Light colour White
Required components:



CREE

LED XP-G2
FWHM 11.0°
Efficiency 87 %
Peak intensity 10.4 cd/Im
LEDs/each optic 1
Light colour White
Required components:
C12479_MIRELLA-DL

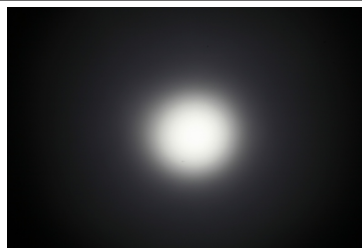

CREE

LED XP-L HI
FWHM 7.7°
Efficiency 90 %
Peak intensity 24.9 cd/Im
LEDs/each optic 1
Light colour White
Required components:

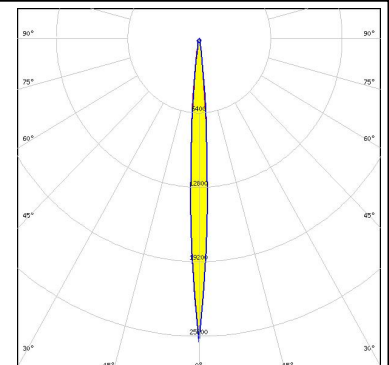
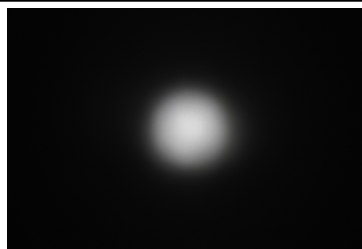

PHOTOMETRIC DATA (MEASURED):

CREE

LED XT-E
 FWHM 11.0°
 Efficiency 85 %
 Peak intensity 9.9 cd/lm
 LEDs/each optic 1
 Light colour White
 Required components:
 C12479_MIRELLA-DL



CREE

LED XT-E
 FWHM 7.6°
 Efficiency 89 %
 Peak intensity 24 cd/lm
 LEDs/each optic 1
 Light colour White
 Required components:



CREE

LED XT-E
 FWHM 10.0°
 Efficiency 84 %
 Peak intensity 14.1 cd/lm
 LEDs/each optic 1
 Light colour White
 Required components:
 C13333_MIRELLA-CL



LUMILEDS

LED LUXEON 5050 Round LES
 FWHM 11.0°
 Efficiency 93 %
 Peak intensity 11.9 cd/lm
 LEDs/each optic 1
 Light colour White
 Required components:

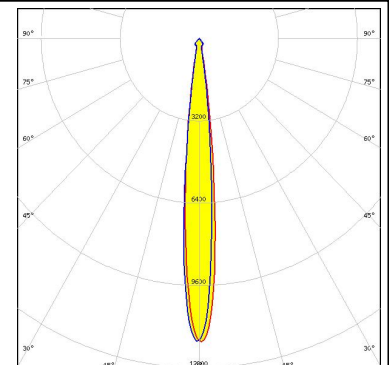

PHOTOMETRIC DATA (MEASURED):

LUMILEDS

LED LUXEON A
 FWHM 12.0°
 Efficiency 85 %
 Peak intensity 8.9 cd/lm
 LEDs/each optic 1
 Light colour White
 Required components:
 C12479_MIRELLA-DL



LUMILEDS

LED LUXEON A
 FWHM 8.9°
 Efficiency 89 %
 Peak intensity 20.5 cd/lm
 LEDs/each optic 1
 Light colour White
 Required components:



LUMILEDS

LED LUXEON A
 FWHM 10.0°
 Efficiency 85 %
 Peak intensity 14.5 cd/lm
 LEDs/each optic 1
 Light colour White
 Required components:
 C13333_MIRELLA-CL



LUMILEDS

LED LUXEON C
 FWHM 22.0°
 Efficiency 81 %
 Peak intensity 3.1 cd/lm
 LEDs/each optic 4
 Light colour RGBW
 Required components:
 C13723_MIRELLA-RZL

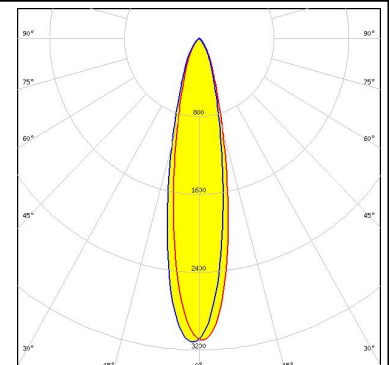
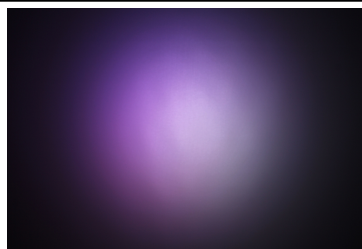

PHOTOMETRIC DATA (MEASURED):

LUMILEDS

LED LUXEON M/MX
 FWHM 15.0°
 Efficiency 86 %
 Peak intensity 5.9 cd/lm
 LEDs/each optic 1
 Light colour White
 Required components:
 C12479_MIRELLA-DL



LUMILEDS

LED LUXEON M/MX
 FWHM 12.0°
 Efficiency 91 %
 Peak intensity 10.3 cd/lm
 LEDs/each optic 1
 Light colour White
 Required components:

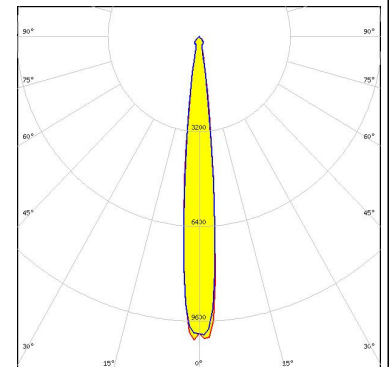

LUMILEDS

LED LUXEON M/MX
 FWHM 15.0°
 Efficiency 85 %
 Peak intensity 7.2 cd/lm
 LEDs/each optic 1
 Light colour White
 Required components:
 C13333_MIRELLA-CL





LUMILEDS



LED LUXEON MZ
 FWHM 11.0°
 Efficiency 85 %
 Peak intensity 9.3 cd/lm
 LEDs/each optic 1
 Light colour White
 Required components:
 C12479_MIRELLA-DL

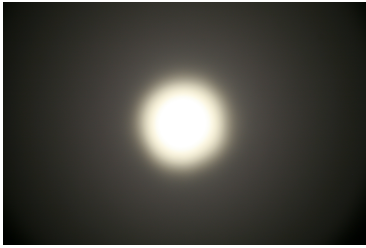
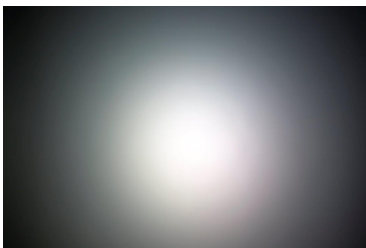
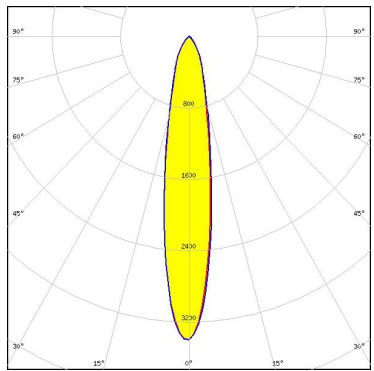

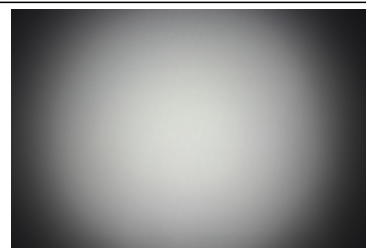
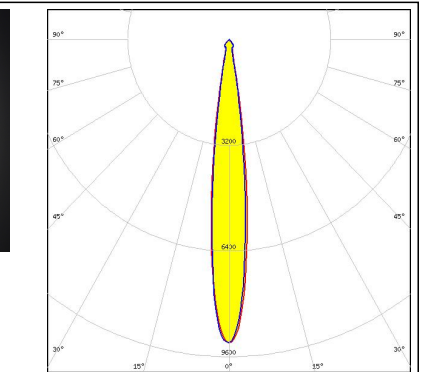

PHOTOMETRIC DATA (MEASURED):

<p>LUMILEDS</p> <p>LED LUXEON MZ FWHM 8.7° Efficiency 90 % Peak intensity 19.3 cd/lm LEDs/each optic 1 Light colour White Required components:</p>	
<p>LUMILEDS</p> <p>LED LUXEON Z FWHM 18.0° Efficiency 82 % Peak intensity 3.4 cd/lm LEDs/each optic 4 Light colour RGBW Required components: C13723_MIRELLA-RZL</p>	 
<p>NICHIA</p> <p>LED NS9x383 FWHM 12.0° Efficiency 85 % Peak intensity 8.4 cd/lm LEDs/each optic 1 Light colour White Required components: C12479_MIRELLA-DL</p>	
<p>NICHIA</p> <p>LED NS9x383 FWHM 9.2° Efficiency 89 % Peak intensity 17.7 cd/lm LEDs/each optic 1 Light colour White Required components:</p>	

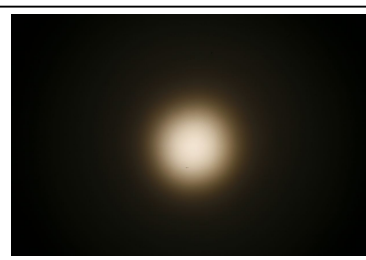
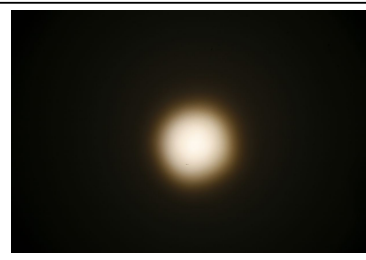
PHOTOMETRIC DATA (MEASURED):

<p>NICHIA</p> <p>LED NV4x144A FWHM 13.0° Efficiency 92 % Peak intensity 9.2 cd/lm LEDs/each optic 1 Light colour White Required components:</p>		
<p>OSRAM <small>Opto Semiconductors</small></p> <p>LED Duris S8 FWHM 11.0° Efficiency 86 % Peak intensity 11.6 cd/lm LEDs/each optic 1 Light colour White Required components: C13333_MIRELLA-CL</p>		
<p>OSRAM <small>Opto Semiconductors</small></p> <p>LED Duris S8 FWHM 12.0° Efficiency 86 % Peak intensity 8.3 cd/lm LEDs/each optic 1 Light colour White Required components: C12479_MIRELLA-DL</p>		
<p>OSRAM <small>Opto Semiconductors</small></p> <p>LED Duris S8 FWHM 9.7° Efficiency 91 % Peak intensity 16 cd/lm LEDs/each optic 1 Light colour White Required components:</p>		

PHOTOMETRIC DATA (MEASURED):

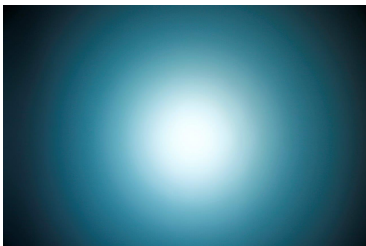
<p>OSRAM Opto Semiconductors</p> <p>LED OSLON Square EC FWHM 11.0° Efficiency 85 % Peak intensity 9.7 cd/lm LEDs/each optic 1 Light colour White Required components: C12479_MIRELLA-DL</p>	
<p>OSRAM Opto Semiconductors</p> <p>LED OSLON Square EC FWHM 8.0° Efficiency 90 % Peak intensity 23.6 cd/lm LEDs/each optic 1 Light colour White Required components:</p>	
<p>OSRAM Opto Semiconductors</p> <p>LED OSLON Square EC FWHM 9.4° Efficiency 85 % Peak intensity 15.4 cd/lm LEDs/each optic 1 Light colour White Required components: C13333_MIRELLA-CL</p>	
<p>OSRAM Opto Semiconductors</p> <p>LED Ostar-SMT RGB FWHM 19.0° Efficiency 85 % Peak intensity 3.7 cd/lm LEDs/each optic 1 Light colour White Required components: C13723_MIRELLA-RZL</p>	

PHOTOMETRIC DATA (MEASURED):

SAMSUNG

LED LH508A
 FWHM 12.0°
 Efficiency 90 %
 Peak intensity 10.5 cd/lm
 LEDs/each optic 1
 Light colour White
 Required components:

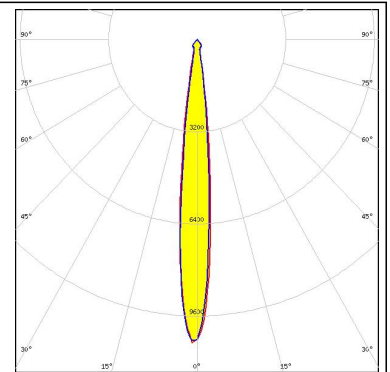

SEOUL SEMICONDUCTOR

LED F50360 (RGB)
 FWHM 21.0°
 Efficiency 84 %
 Peak intensity 3.3 cd/lm
 LEDs/each optic 1
 Light colour White
 Required components:
 C13723_MIRELLA-RZL

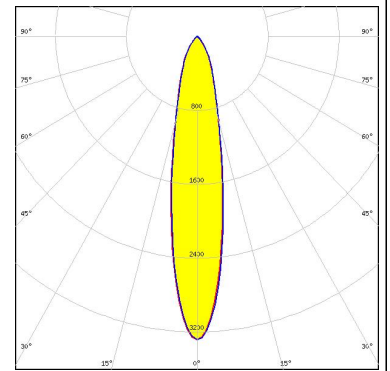
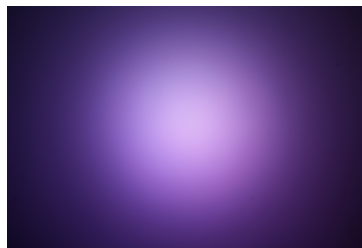

SEOUL SEMICONDUCTOR

LED F50360 (RGB)
 FWHM 19.0°
 Efficiency 86 %
 Peak intensity 3.8 cd/lm
 LEDs/each optic 1
 Light colour White
 Required components:
 C13723_MIRELLA-RZL

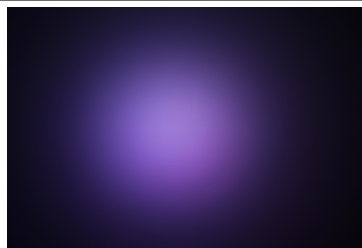

PHOTOMETRIC DATA (SIMULATED):



LED XHP35 HD
 FWHM 11.0°
 Efficiency 92 %
 Peak intensity 11.8 cd/lm
 LEDs/each optic 1
 Light colour White
 Required components:

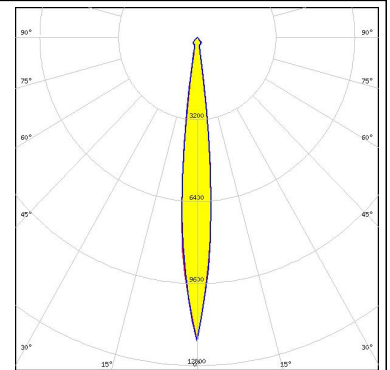

LED LUXEON 5258
 FWHM 9.0°
 Efficiency 91 %
 Peak intensity 17 cd/lm
 LEDs/each optic 1
 Light colour White
 Required components:

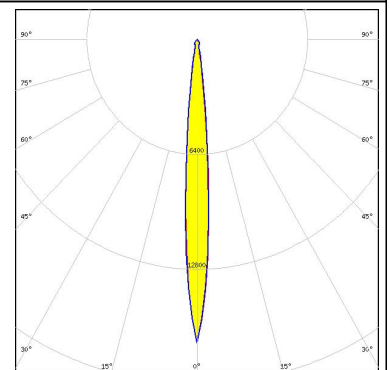

LED OSCONIQ P 7070
 FWHM 11.0°
 Efficiency 87 %
 Peak intensity 10.4 cd/lm
 LEDs/each optic 1
 Light colour White
 Required components:
 C13333_MIRELLA-CL

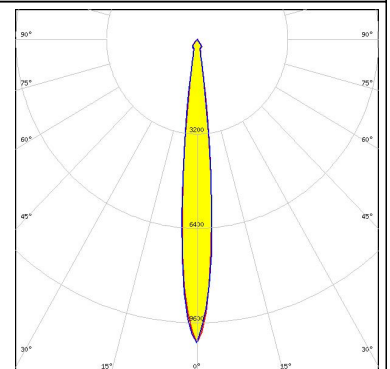
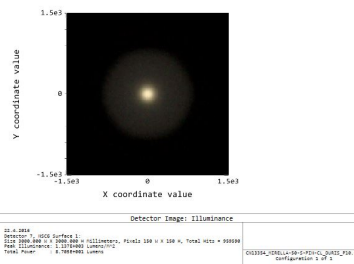

LED OSCONIQ P 7070
 FWHM 10.0°
 Efficiency 92 %
 Peak intensity 11.6 cd/lm
 LEDs/each optic 1
 Light colour White
 Required components:

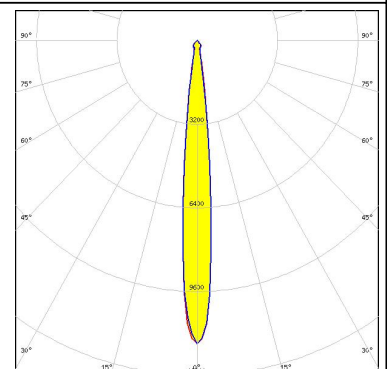
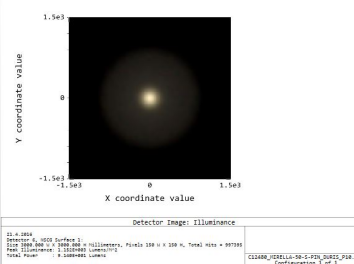

PHOTOMETRIC DATA (SIMULATED):



GENERAL INFORMATION:

NOTE: The typical beam angle will be changed by different color, chip size and chip position tolerance. The typical total beam angle is the full angle measured where the luminous intensity is half of the peak value.

MATERIALS:

As part of our continuous research and improvement processes, and to ensure the best possible quality and availability of our products, LEDiL reserves the right to change material grades without notice.

PRODUCT DATA USER AGREEMENT AND DISCLAIMER:

The measured data in the provided downloadable LEDiL Product Datasheets and Mechanical 2D-Drawings is rounded and provided as reference for planning. LEDiL Oy's optical specifications have been verified by conducting performance testing of the products in accordance with the company's quality system. The reported data are averaged results of multiple measurements with typical variation. LEDiL Oy reserves the right to without prior notification make changes and improvements to its products.

LEDiL Oy assumes neither warranty, nor guarantee nor any other liability of any kind for the contents and correctness of the provided data. The provided data has been generated with highest diligence but the provided data may in reality not represent the complete possible variation range of all intrinsic parameters. Therefore, in certain cases a deviation from the provided data could occur.

LEDiL Oy reserves the right to undertake technical changes of its products without further notification which could lead to changes in the provided data. LEDiL Oy assumes no liability of any kind for the possible deviation from any provided data or any other damage resulting from the usage of the provided data.

The user agrees to this disclaimer and user agreement with the download or usage of the provided files.

LEDiL Oy

Joensuunkatu 13
FI-24240 SALO
Finland

LEDiL Inc.

228 West Page Street
Suite D
Sycamore IL 60178
USA

Local sales and technical support

[www.ledil.com/
where_to_buy](http://www.ledil.com/where_to_buy)

Shipping locations

Salo, Finland
Hong Kong, China

Distribution Partners

[www.ledil.com/
where_to_buy](http://www.ledil.com/where_to_buy)

Данный компонент на территории Российской Федерации

Вы можете приобрести в компании MosChip.

Для оперативного оформления запроса Вам необходимо перейти по данной ссылке:

<http://moschip.ru/get-element>

Вы можете разместить у нас заказ для любого Вашего проекта, будь то серийное производство или разработка единичного прибора.

В нашем ассортименте представлены ведущие мировые производители активных и пассивных электронных компонентов.

Нашей специализацией является поставка электронной компонентной базы двойного назначения, продукции таких производителей как XILINX, Intel (ex.ALTERA), Vicor, Microchip, Texas Instruments, Analog Devices, Mini-Circuits, Amphenol, Glenair.

Сотрудничество с глобальными дистрибьюторами электронных компонентов, предоставляет возможность заказывать и получать с международных складов практически любой перечень компонентов в оптимальные для Вас сроки.

На всех этапах разработки и производства наши партнеры могут получить квалифицированную поддержку опытных инженеров.

Система менеджмента качества компании отвечает требованиям в соответствии с ГОСТ Р ИСО 9001, ГОСТ РВ 0015-002 и ЭС РД 009

Офис по работе с юридическими лицами:

105318, г.Москва, ул.Щербаковская д.3, офис 1107, 1118, ДЦ «Щербаковский»

Телефон: +7 495 668-12-70 (многоканальный)

Факс: +7 495 668-12-70 (доб.304)

E-mail: info@moschip.ru

Skype отдела продаж:

moschip.ru

moschip.ru_4

moschip.ru_6

moschip.ru_9