

# High Power Infrared Emitter (850 nm) Version 1.2

---

## SFH 4254



### Features:

- Homogenous Radiation Pattern
- Typical Peakwavelength 860 nm
- Short switching times
- Moisture Sensitivity Level 2 according to JEDEC Standard J-STD-020D.01
- The product qualification test plan is based on the guidelines of AEC-Q101-REV-C, Stress Test Qualification for Automotive Grade Discrete Semiconductors.

### Applications

- Data transmission
- Gesture recognition systems
- Sensor technology

### Notes

Depending on the mode of operation, these devices emit highly concentrated non visible infrared light which can be hazardous to the human eye. Products which incorporate these devices have to follow the safety precautions given in IEC 60825-1 and IEC 62471.

### Ordering Information

Type:	Radiant Intensity $I_e$ [mW/sr] $I_F = 70 \text{ mA}, t_p = 20 \text{ ms}$	Ordering Code
SFH 4254	12 ( $\geq 6.3$ )	Q65110A6462

*Note:* Measured at a solid angle of  $\Omega = 0.01 \text{ sr}$

**Maximum Ratings** ( $T_A = 25\text{ °C}$ )

Parameter	Symbol	Values	Unit
Operation and storage temperature range	$T_{op}; T_{stg}$	-40 ... 100	°C
Reverse voltage	$V_R$	5	V
Forward current	$I_F$	70	mA
Surge current ( $t_p \leq 10\ \mu\text{s}$ , $D = 0$ )	$I_{FSM}$	1	A
Power consumption	$P_{tot}$	125	mW
ESD withstand voltage (acc. to ANSI/ ESDA/ JEDEC JS-001 - HBM)	$V_{ESD}$	2	kV
Thermal resistance junction - ambient <sup>1) page 12</sup>	$R_{thJA}$	530	K / W
Thermal resistance junction - soldering point <sup>2) page 12</sup>	$R_{thJS}$	300	K / W

**Characteristics** ( $T_A = 25\text{ °C}$ )

Parameter		Symbol	Values	Unit
Peak wavelength ( $I_F = 70\text{ mA}$ , $t_p = 20\text{ ms}$ )	(typ)	$\lambda_{peak}$	860	nm
Centroid wavelength ( $I_F = 70\text{ mA}$ , $t_p = 20\text{ ms}$ )	(typ)	$\lambda_{centroid}$	850	nm
Spectral bandwidth at 50% of $I_{max}$ ( $I_F = 70\text{ mA}$ , $t_p = 20\text{ ms}$ )	(typ)	$\Delta\lambda$	30	nm
Half angle	(typ)	$\varphi$	$\pm 60$	°
Dimensions of active chip area	(typ)	L x W	0.3 x 0.3	mm x mm
Rise and fall time of $I_e$ ( 10% and 90% of $I_{e\ max}$ ) ( $I_F = 70\text{ mA}$ , $R_L = 50\ \Omega$ )	(typ)	$t_r, t_f$	12	ns
Forward voltage ( $I_F = 70\text{ mA}$ , $t_p = 20\text{ ms}$ )	(typ (max))	$V_F$	1.45 ( $\leq 1.75$ )	V
Forward voltage ( $I_F = 1\text{ A}$ , $t_p = 100\ \mu\text{s}$ )	(typ (max))	$V_F$	2.4 ( $\leq 3$ )	V
Reverse current ( $V_R = 5\text{ V}$ )		$I_R$	not designed for reverse operation	$\mu\text{A}$
Total radiant flux ( $I_F = 70\text{ mA}$ , $t_p = 20\text{ ms}$ )	(typ)	$\Phi_e$	40	mW

Parameter		Symbol	Values	Unit
Temperature coefficient of $I_e$ or $\Phi_e$ ( $I_F = 70 \text{ mA}$ , $t_p = 20 \text{ ms}$ )	(typ)	$TC_I$	-0.5	% / K
Temperature coefficient of $V_F$ ( $I_F = 70 \text{ mA}$ , $t_p = 20 \text{ ms}$ )	(typ)	$TC_V$	-0.7	mV / K
Temperature coefficient of wavelength ( $I_F = 70 \text{ mA}$ , $t_p = 20 \text{ ms}$ )	(typ)	$TC_\lambda$	0.3	nm / K

### Grouping ( $T_A = 25^\circ\text{C}$ )

Group	Min Radiant Intensity $I_F = 70 \text{ mA}$ , $t_p = 20 \text{ ms}$ $I_{e, \text{min}}$ [mW / sr]	Max Radiant Intensity $I_F = 70 \text{ mA}$ , $t_p = 20 \text{ ms}$ $I_{e, \text{max}}$ [mW / sr]	Typ Radiant Intensity $I_F = 1 \text{ A}$ , $t_p = 25 \mu\text{s}$ $I_{e, \text{typ}}$ [mW / sr]
SFH 4254-Q	6.3	12.5	95
SFH 4254-R	10	20	150

Note: measured at a solid angle of  $\Omega = 0.01 \text{ sr}$

Only one group in one packing unit (variation lower 2:1).

### Relative Spectral Emission <sup>3) page 12</sup>

$$I_{\text{rel}} = f(\lambda), T_A = 25^\circ\text{C}$$

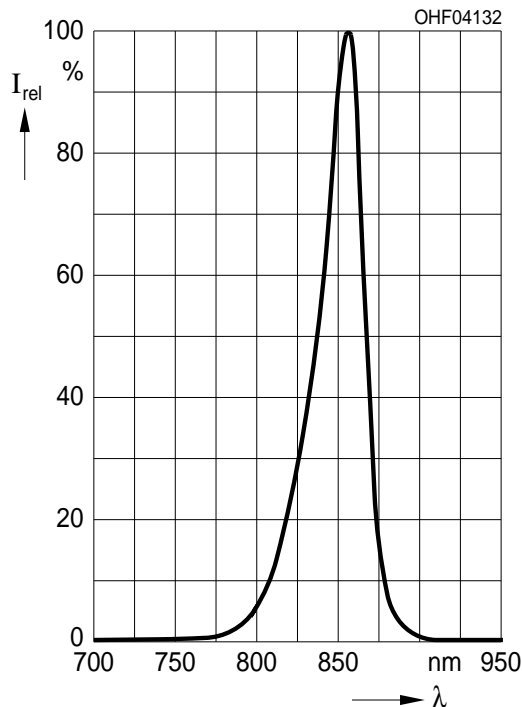

### Radiant Intensity <sup>3) page 12</sup>

$$I_e / I_e(70 \text{ mA}) = f(I_F), \text{ single pulse, } t_p = 25 \mu\text{s}, T_A = 25^\circ\text{C}$$

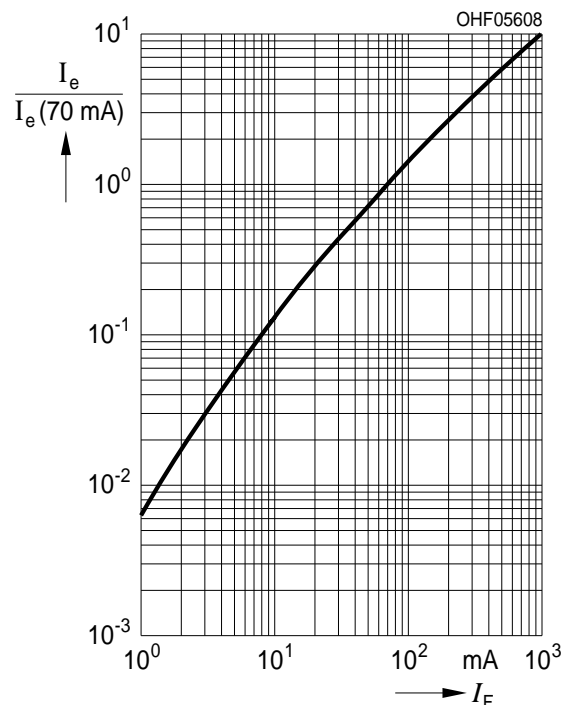

**Max. Permissible Forward Current**

$I_{F, \max} = f(T_A), R_{thJA} = 530 \text{ K / W}$

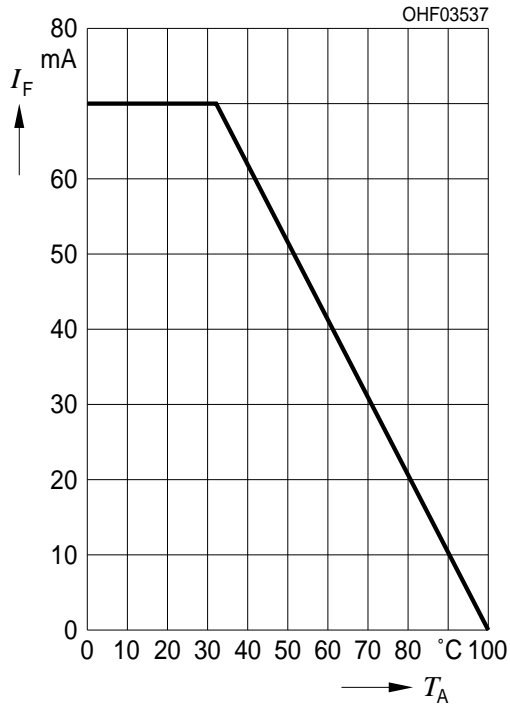

**Forward Current** <sup>3) page 12</sup>

$I_F = f(V_F), \text{ single pulse, } t_p = 100 \mu\text{s}, T_A = 25^\circ\text{C}$

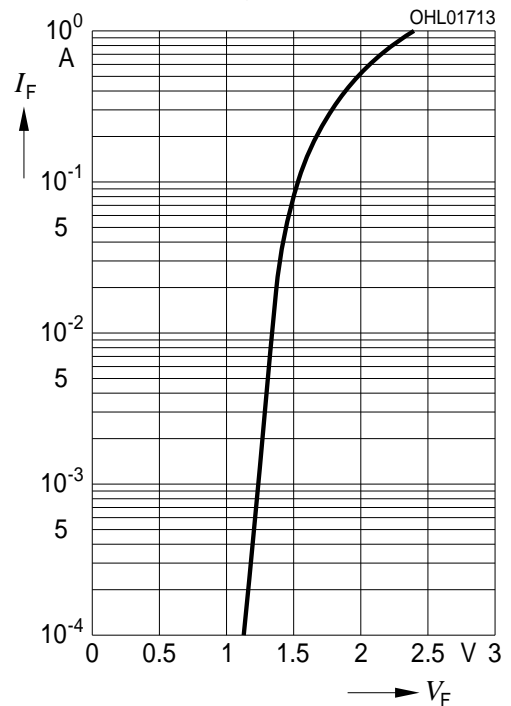

**Permissible Pulse Handling Capability**

$I_F = f(t_p), T_A = 25^\circ\text{C}, \text{ duty cycle } D = \text{parameter}$

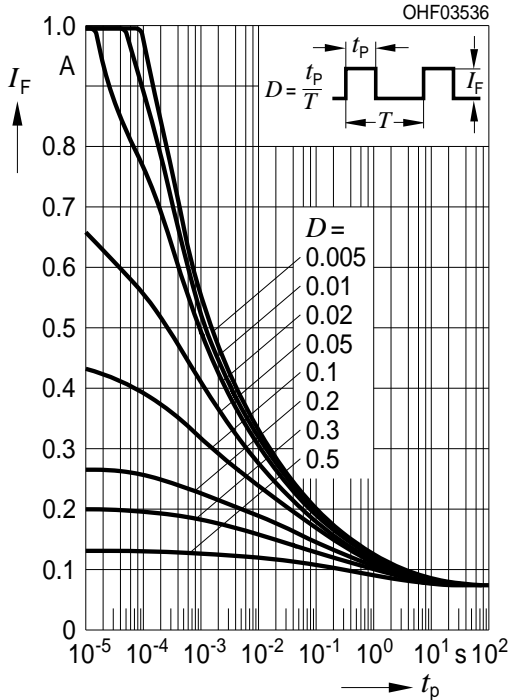

**Radiation Characteristics** <sup>3) page 12</sup>

$I_{rel} = f(\phi), T_A = 25^\circ C$

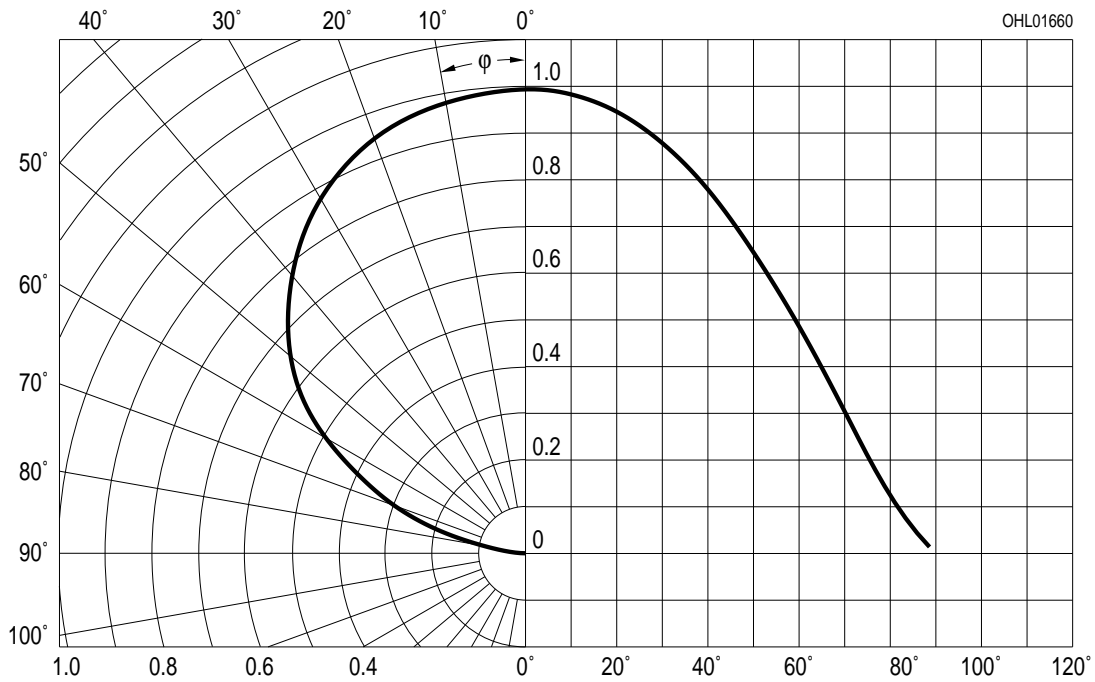

**Package Outline**

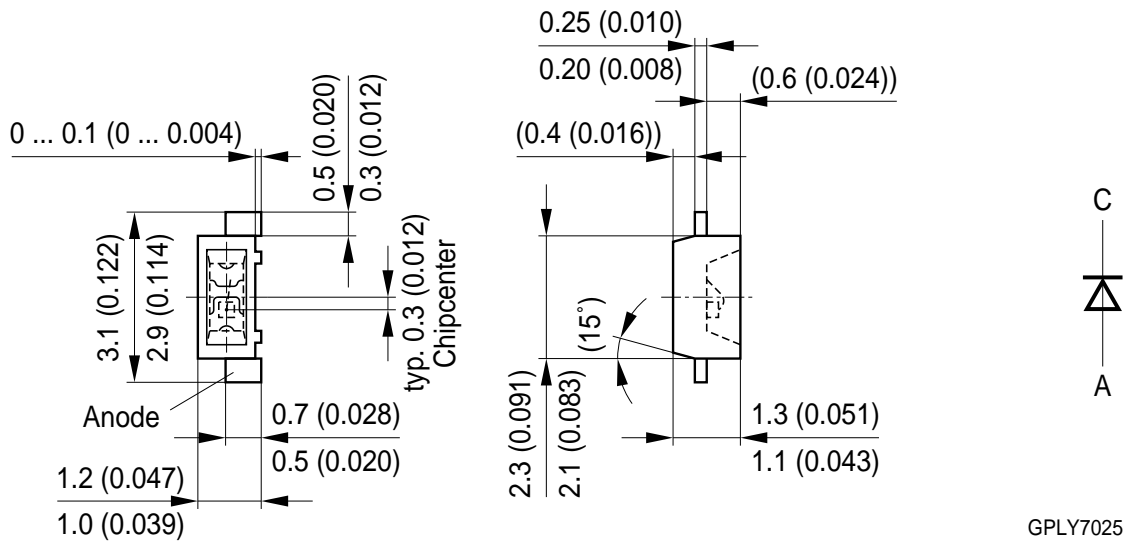

GPLY7025

*Dimensions in mm (inch).*

**Package**

Micro SIDELED

**Approximate Weight:**

6 mg

**Recommended Solder Pad**

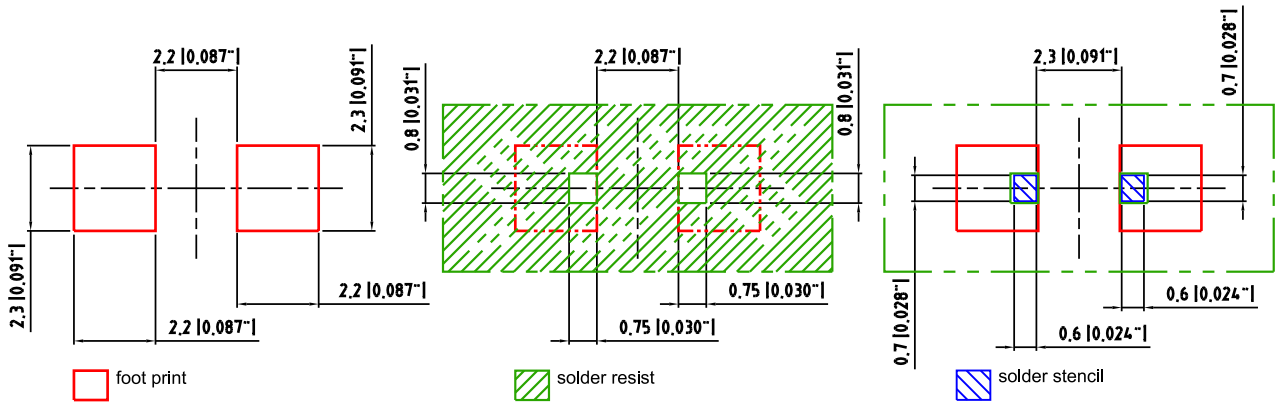

**Component Location on Pad**

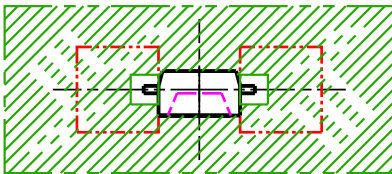

*Dimensions in mm (inch).*

E062 3010 144 - 02

## Reflow Soldering Profile

Product complies to MSL Level 2 acc. to JEDEC J-STD-020D.01

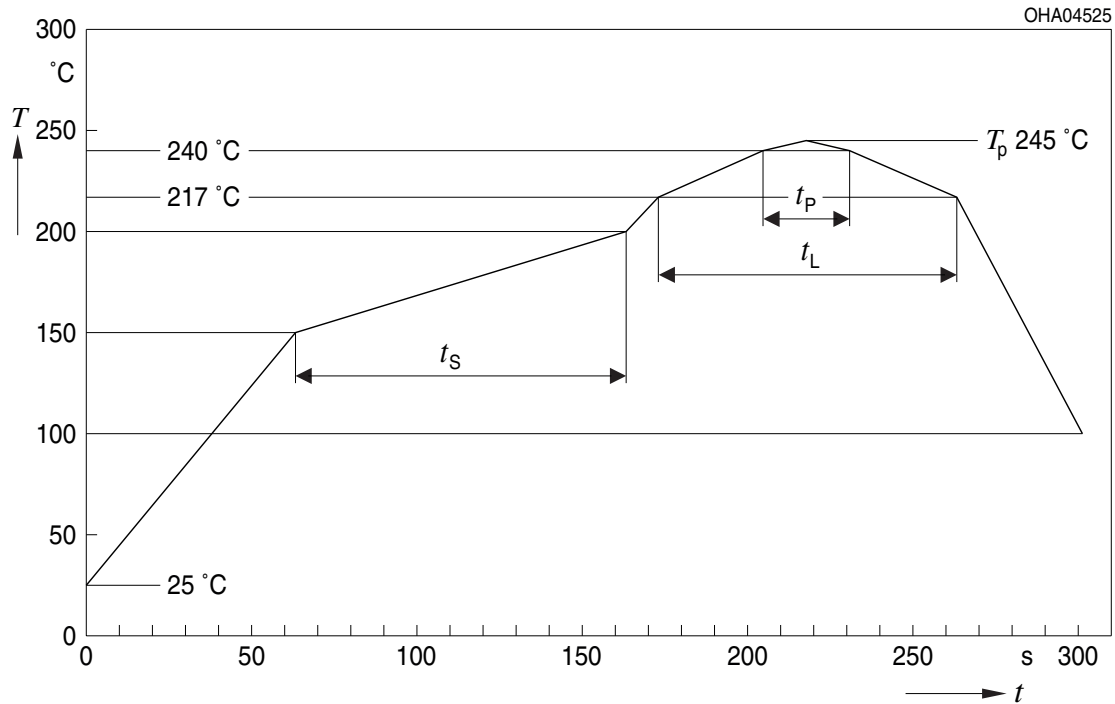

OHA04612

Profile Feature Profil-Charakteristik	Symbol Symbol	Pb-Free (SnAgCu) Assembly			Unit Einheit
		Minimum	Recommendation	Maximum	
Ramp-up rate to preheat*) 25 °C to 150 °C			2	3	K/s
Time $t_s$ $T_{Smin}$ to $T_{Smax}$	$t_s$	60	100	120	s
Ramp-up rate to peak*) $T_{Smax}$ to $T_p$			2	3	K/s
Liquidus temperature	$T_L$		217		°C
Time above liquidus temperature	$t_L$		80	100	s
Peak temperature	$T_p$		245	260	°C
Time within 5 °C of the specified peak temperature $T_p - 5$ K	$t_p$	10	20	30	s
Ramp-down rate* $T_p$ to 100 °C			3	6	K/s
Time 25 °C to $T_p$				480	s

All temperatures refer to the center of the package, measured on the top of the component

\* slope calculation  $DT/Dt$ :  $Dt$  max. 5 s; fulfillment for the whole T-range

**Taping**

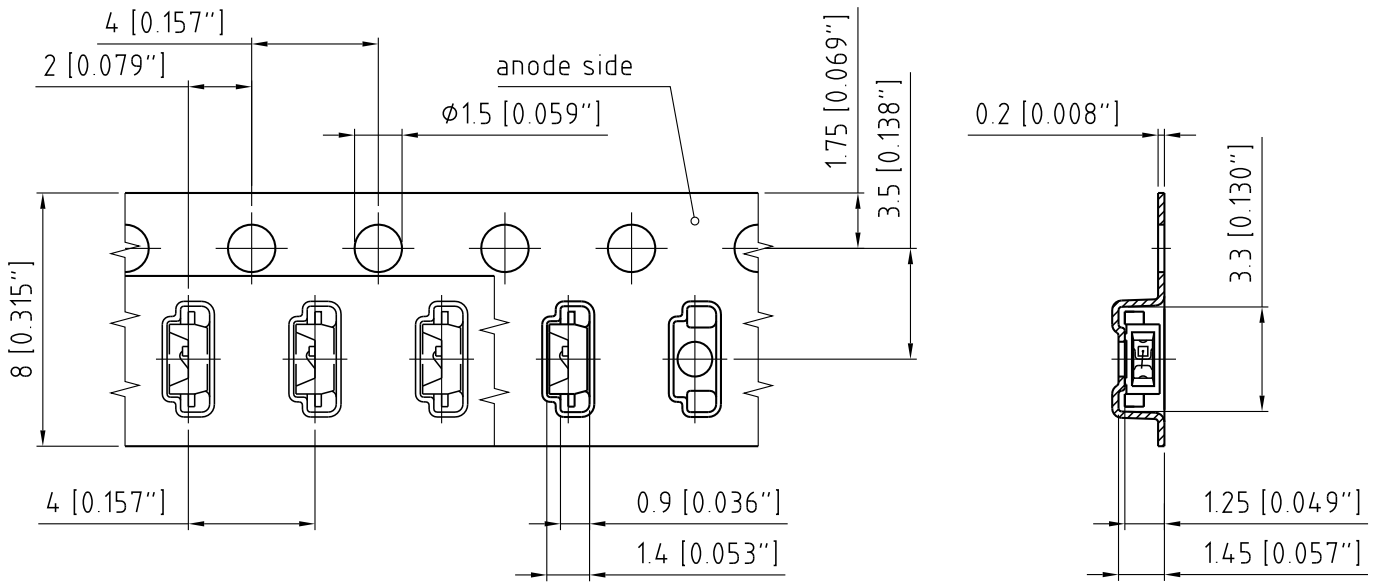

C63062-A3973-B2-02

*Dimensions in mm (inch).*

**Tape and Reel**

8 mm tape with 3000 pcs. on  $\phi 180$  mm reel

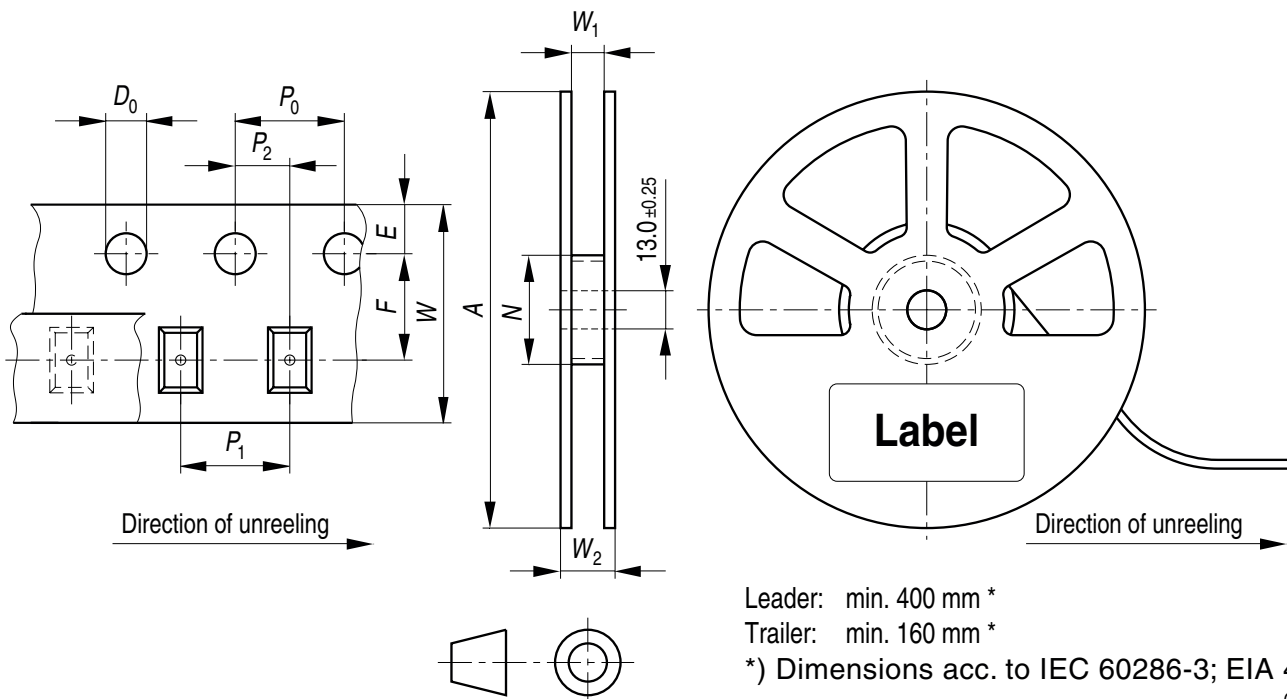

OHAY0324



## Tape dimensions [mm]

W	P <sub>0</sub>	P <sub>1</sub>	P <sub>2</sub>	D <sub>0</sub>	E	F
8 + 0.3 / -0.1	4 ± 0.1	2 ± 0.05 or 4 ± 0.1	2 ± 0.05	1.5 ± 0.1	1.75 ± 0.1	3.5 ± 0.05

## Reel dimensions [mm]

A	W	N <sub>min</sub>	W <sub>1</sub>	W <sub>2max</sub>
180	8	60	8.4 + 2	14.4

## Barcode-Product-Label (BPL)

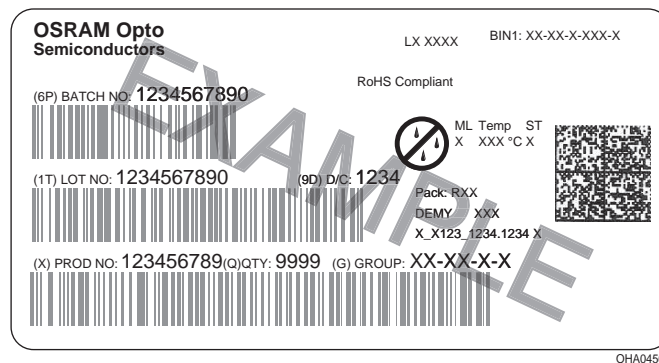

## Dry Packing Process and Materials



## Note:

Moisture-sensitive product is packed in a dry bag containing desiccant and a humidity card. Regarding dry pack you will find further information in the internet. Here you will also find the normative references like JEDEC.

## Transportation Packing and Materials

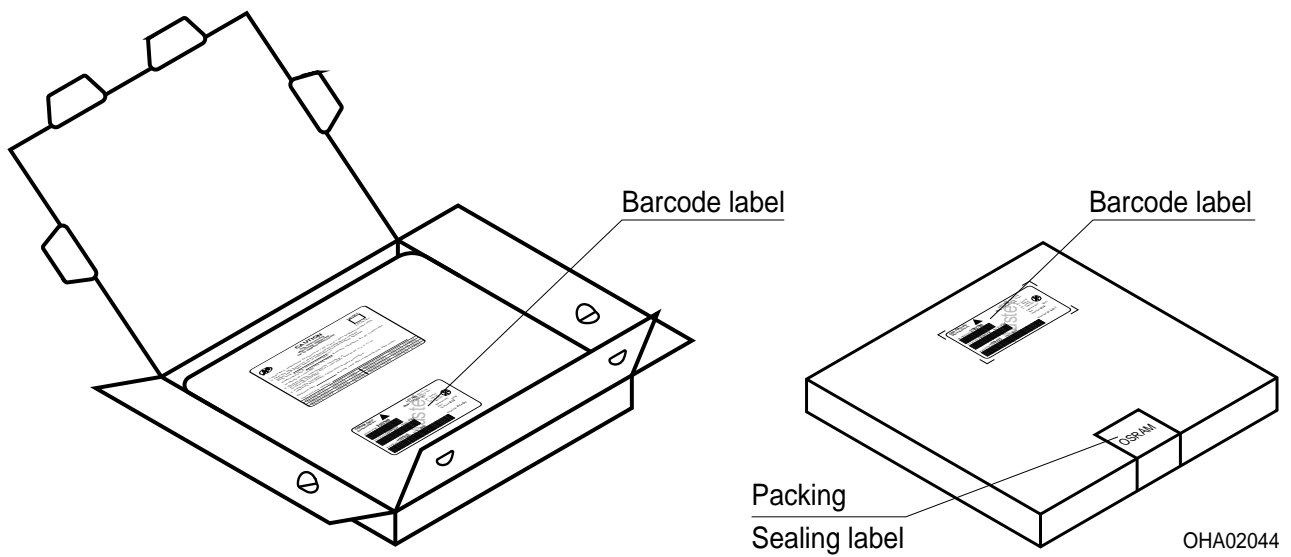

## Dimensions of transportation box in mm

Width	Length	Height
200 ± 5	195 ± 5	30 ± 5

**Disclaimer**

Language english will prevail in case of any discrepancies or deviations between the two language wordings.

**Attention please!**

The information describes the type of component and shall not be considered as assured characteristics.

Terms of delivery and rights to change design reserved. Due to technical requirements components may contain dangerous substances.

For information on the types in question please contact our Sales Organization.

If printed or downloaded, please find the latest version in the Internet.

**Packing**

Please use the recycling operators known to you. We can also help you – get in touch with your nearest sales office.

By agreement we will take packing material back, if it is sorted. You must bear the costs of transport. For packing material that is returned to us unsorted or which we are not obliged to accept, we shall have to invoice you for any costs incurred.

**Components used in life-support devices or systems must be expressly authorized for such purpose!**

Critical components\* may only be used in life-support devices\*\* or systems with the express written approval of OSRAM OS.

\*) A critical component is a component used in a life-support device or system whose failure can reasonably be expected to cause the failure of that life-support device or system, or to affect its safety or the effectiveness of that device or system.

\*\*) Life support devices or systems are intended (a) to be implanted in the human body, or (b) to support and/or maintain and sustain human life. If they fail, it is reasonable to assume that the health and the life of the user may be endangered.

**Glossary**

- 1) **Thermal resistance:** junction -ambient, mounted on PC-board (FR4), pads size 5 mm<sup>2</sup> each
- 2) **Thermal resistance:** junction - soldering point, of the device only, mounted on an ideal heatsink (e.g. metal block)
- 3) **Typical Values:** Due to the special conditions of the manufacturing processes of LED, the typical data or calculated correlations of technical parameters can only reflect statistical figures. These do not necessarily correspond to the actual parameters of each single product, which could differ from the typical data and calculated correlations or the typical characteristic line. If requested, e.g. because of technical improvements, these typ. data will be changed without any further notice.

**Published by OSRAM Opto Semiconductors GmbH**  
**Leibnizstraße 4, D-93055 Regensburg**  
**www.osram-os.com © All Rights Reserved.**

EU RoHS and China RoHS compliant product



此产品符合欧盟 RoHS 指令的要求；  
按照中国的相关法规和标准，不含有毒有害物质或元素。

## Данный компонент на территории Российской Федерации

### Вы можете приобрести в компании MosChip.

Для оперативного оформления запроса Вам необходимо перейти по данной ссылке:

<http://moschip.ru/get-element>

Вы можете разместить у нас заказ для любого Вашего проекта, будь то серийное производство или разработка единичного прибора.

В нашем ассортименте представлены ведущие мировые производители активных и пассивных электронных компонентов.

Нашей специализацией является поставка электронной компонентной базы двойного назначения, продукции таких производителей как XILINX, Intel (ex.ALTERA), Vicor, Microchip, Texas Instruments, Analog Devices, Mini-Circuits, Amphenol, Glenair.

Сотрудничество с глобальными дистрибьюторами электронных компонентов, предоставляет возможность заказывать и получать с международных складов практически любой перечень компонентов в оптимальные для Вас сроки.

На всех этапах разработки и производства наши партнеры могут получить квалифицированную поддержку опытных инженеров.

Система менеджмента качества компании отвечает требованиям в соответствии с ГОСТ Р ИСО 9001, ГОСТ РВ 0015-002 и ЭС РД 009

### Офис по работе с юридическими лицами:

105318, г.Москва, ул.Щербаковская д.3, офис 1107, 1118, ДЦ «Щербаковский»

Телефон: +7 495 668-12-70 (многоканальный)

Факс: +7 495 668-12-70 (доб.304)

E-mail: [info@moschip.ru](mailto:info@moschip.ru)

Skype отдела продаж:

moschip.ru

moschip.ru\_4

moschip.ru\_6

moschip.ru\_9