

FEATURES

- * High collector-emitter voltage
($V_{CEO} = 70V$)
- * High input-output isolation voltage
($V_{iso} = 5,000V_{rms}$)
- * Response time
(t_r : TYP. $5\mu s$ at $V_{CC} = 10V$, $I_C = 2mA$, $R_L = 100\Omega$)
- * Current transfer ratio
(CTR : MIN. 40% at $I_F = 10mA$, $V_{CE} = 5V$)
- * Dual-in-line package :
CNY17-1, CNY17-2, CNY17-3, CNY17-4
- * Wide lead spacing package :
CNY17-1M, CNY17-2M, CNY17-3M, CNY17-4M
- * Surface mounting package :
CNY17-1S, CNY17-2S, CNY17-3S, CNY17-4S
- * Tape and reel packaging :
(TYPE D) CNY17-1S-TA1, CNY17-2S-TA1, CNY17-3S-TA1, CNY17-4S-TA1
- * UL approved (No. E113898)
- * FIMKO approved (No. 209049)
- * NEMKO approved (No. P99102464)
- * DEMKO approved (No. 99-04182)
- * SEMKO approved (No. 9943380 / 01-20)
- * VDE approved (No. 094722)
- * CSA approve in progress

OUTLINE DIMENSIONS

Dual-in-line package :

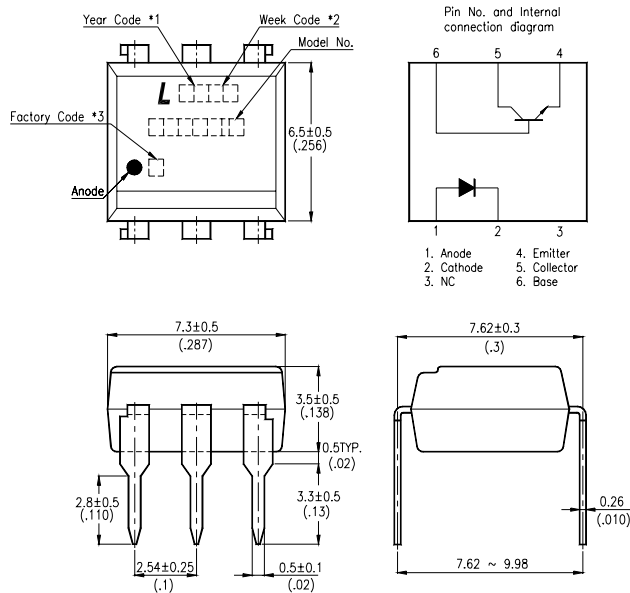

Wide lead spacing package:



- *1. Year date code.
- *2. 2-digit work week.
- *3. Factory identification mark shall be marked (Z : Taiwan, Y : Thailand, X : China).
- *4. Model No.: CNY17-1, CNY17-2, CNY17-3, CNY17-4

OUTLINE DIMENSIONS

Surface mounting package :



- *1. Year date code.
- *2. 2-digit work week.
- *3. Factory identification mark shall be marked (Z : Taiwan, Y : Thailand, X : China).
- *4. Model No.: CNY17-1, CNY17-2, CNY17-3, CNY17-4

TAPING DIMENSIONS

Tape and reel package (TYPE I):



Description	Symbol	Dimensions in mm (inches)
Tape wide	W	16 ± 0.3 (.63)
Pitch of sprocket holes	P_0	4 ± 0.1 (.15)
Distance of compartment	F	7.5 ± 0.1 (.295)
Distance of compartment to compartment	P_1	2 ± 0.1 (.079)
Distance of compartment to compartment	P_2	12 ± 0.1 (.472)

ABSOLUTE MAXIMUM RATING

(Ta = 25°C)

PARAMETER		SYMBOL	RATING	UNIT
INPUT	Forward Current	I _F	60	mA
	Reverse Voltage	V _R	6	V
	Power Dissipation	P	100	mW
OUTPUT	Collector - Emitter Voltage	V _{CEO}	70	V
	Emitter - Collector Voltage	V _{ECO}	7	V
	Collector - Base Voltage	V _{CBO}	70	V
	Collector Current	I _C	150	mA
	Collector Power Dissipation	P _C	150	mW
Total Power Dissipation		P _{tot}	250	mW
*1	Isolation Voltage	V _{iso}	5,000	V _{rms}
Operating Temperature		T _{opr}	-55 ~ +100	°C
Storage Temperature		T _{stg}	-55 ~ +150	°C
*2	Soldering Temperature	T _{sol}	260	°C

*1. AC For 1 Minute, R.H. = 40 ~ 60%

Isolation voltage shall be measured using the following method.

- (1) Short between anode and cathode on the primary side and between collector, emitter and base on the secondary side.
- (2) The isolation voltage tester with zero-cross circuit shall be used.
- (3) The waveform of applied voltage shall be a sine wave.

*2. For 10 Seconds

ELECTRICAL - OPTICAL CHARACTERISTICS

(Ta = 25°C)

PARAMETER		SYMBOL	MIN.	TYP.	MAX.	UNIT	CONDITIONS	
INPUT	Forward Voltage	V _F	—	1.45	1.65	V	I _F =60mA	
	Reverse Current	I _R	—	—	10	μA	V _R =6V	
	Terminal Capacitance	C _t	—	—	100	pF	V=0, f=1MHz	
OUTPUT	Collector Dark Current	I _{CEO}	—	—	50	nA	V _{CE} =10V, I _F =0	
	Collector-Emitter Breakdown Voltage	BV _{CEO}	70	—	—	V	I _C =0.1mA I _F =0	
	Emitter-Collector Breakdown Voltage	BV _{ECO}	7	—	—	V	I _E =10μA I _F =0	
	Collector-Base Breakdown Voltage	BV _{CBO}	70	—	—	V	I _C =0.1mA I _F =0	
TRANSFER CHARACTERISTICS	* Current Transfer Ratio	CNY17-1	CTR	40	—	80	%	I _F =10mA V _{CE} =5V
		CNY17-2		63	—	125		
		CNY17-3		100	—	200		
		CNY17-4		160	—	320		
	Collector-Emitter Saturation Voltage	V _{CE(sat)}	—	—	0.3	V	I _F =10mA I _C =2.5mA	
	Isolation Resistance	R _{iso}	100	—	—	GΩ	DC500V 40 ~ 60% R.H.	
	Floating Capacitance	C _f	—	—	2	pF	V=0, f=1MHz	
	Response Time (Rise)	t _r	—	5	10	μs	V _{CC} =10V, I _C =2mA R _L =100Ω	
	Response Time (Fall)	t _f	—	5	10	μs		

$$* CTR = \frac{I_C}{I_F} \times 100\%$$

CHARACTERISTICS CURVES

Fig.1 Forward Current vs. Ambient Temperature



Fig.2 Collector Power Dissipation vs. Ambient Temperature



Fig.3 Collector-emitter Saturation Voltage vs. Forward Current



Fig.4 Forward Current vs. Forward Voltage



Fig.5 Current Transfer Ratio vs. Forward Current



Fig.6 Collector Current vs. Collector-emitter Voltage



CHARACTERISTICS CURVES

Fig.7 Relative Current Transfer Ratio vs. Ambient Temperature



Fig.8 Collector-emitter Saturation Voltage vs. Ambient Temperature



Fig.9 Collector Dark Current vs. Ambient Temperature



Fig.10 Response Time vs. Load Resistance



Fig.11 Frequency Response



Test Circuit for Response Time



Test Circuit for Frequency Response



RECOMMENDED FOOT PRINT PATTERNS (MOUNT PAD)

Unit : mm



Данный компонент на территории Российской Федерации

Вы можете приобрести в компании MosChip.

Для оперативного оформления запроса Вам необходимо перейти по данной ссылке:

<http://moschip.ru/get-element>

Вы можете разместить у нас заказ для любого Вашего проекта, будь то серийное производство или разработка единичного прибора.

В нашем ассортименте представлены ведущие мировые производители активных и пассивных электронных компонентов.

Нашей специализацией является поставка электронной компонентной базы двойного назначения, продукции таких производителей как XILINX, Intel (ex.ALTERA), Vicor, Microchip, Texas Instruments, Analog Devices, Mini-Circuits, Amphenol, Glenair.

Сотрудничество с глобальными дистрибьюторами электронных компонентов, предоставляет возможность заказывать и получать с международных складов практически любой перечень компонентов в оптимальные для Вас сроки.

На всех этапах разработки и производства наши партнеры могут получить квалифицированную поддержку опытных инженеров.

Система менеджмента качества компании отвечает требованиям в соответствии с ГОСТ Р ИСО 9001, ГОСТ РВ 0015-002 и ЭС РД 009

Офис по работе с юридическими лицами:

105318, г.Москва, ул.Щербаковская д.3, офис 1107, 1118, ДЦ «Щербаковский»

Телефон: +7 495 668-12-70 (многоканальный)

Факс: +7 495 668-12-70 (доб.304)

E-mail: info@moschip.ru

Skype отдела продаж:

moschip.ru

moschip.ru_4

moschip.ru_6

moschip.ru_9