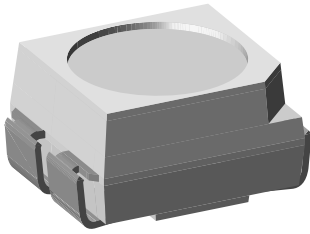


Power SMD LED PLCC-4



19210

DESCRIPTION

The VLMS322.., VLMK322.., VLMO322.., and VLMY322.. series are an advanced development in terms of heat dissipation.

The leadframe profile of this PLCC-4 SMD package is optimized to reduce the thermal resistance.

This allows higher drive current and doubles the light output compared to Vishay's high intensity SMD LED in PLCC-2 package.

PRODUCT GROUP AND PACKAGE DATA

- Product group: LED
- Package: SMD PLCC-4
- Product series: power
- Angle of half intensity: $\pm 60^\circ$

FEATURES

- 3 cathode pins, 1 anode pin
- Available in 8 mm tape
- High brightness SMD LED
- Luminous intensity and color categorized per packing unit
- Luminous intensity ratio per packing unit $I_{Vmax}/I_{Vmin} \leq 1.6$
- ESD-withstand voltage: Up to 2 kV according to JESD22-A114-B
- Suitable for all soldering methods according to CECC 00802 and J-STD-020
- Preconditioning according to JEDEC level 2a
- Qualified according to JEDEC moisture sensitivity level 2a
- Compatible with IR reflow solder processes according to CECC 00802 and J-STD-020
- AEC-Q101 qualified
- Material categorization: For definitions of compliance please see www.vishay.com/doc?99912

 AUTOMOTIVE
GRADE

RoHS
COMPLIANT
HALOGEN
FREE
GREEN
(5-2008)

APPLICATIONS

- Interior and exterior lighting
- Indicator and backlighting purposes for audio, video, LCDs, switches, symbols, illuminated advertising etc.
- Illumination purpose, alternative to incandescent lamps
- General use

PARTS TABLE

PART	COLOR	LUMINOUS INTENSITY (mcd)			at I _F (mA)	WAVELENGTH (nm)			at I _F (mA)	FORWARD VOLTAGE (V)			at I _F (mA)	TECHNOLOGY
		MIN.	TYP.	MAX.		MIN.	TYP.	MAX.		MIN.	TYP.	MAX.		
VLMS322T2V1-GS08	Super red	355	450	900	50	625	630	640	50	1.7	2.1	2.6	50	AllInGaP on GaAs
VLMK322U1V2-GS08	Amber	450	750	1125	50	610	-	621	50	-	1.9	2.6	50	AllInGaP on GaAs
VLMO322U1V2-GS08	Soft orange	450	750	1125	50	600	605	612	50	1.7	2.1	2.6	50	AllInGaP on GaAs
VLMY322U1V2-GS08	Yellow	450	750	1125	50	582	588	594	50	1.7	2.1	2.6	50	AllInGaP on GaAs

ABSOLUTE MAXIMUM RATINGS (T_{amb} = 25 °C, unless otherwise specified) VLMS322.., VLMK322.., VLMO322.., VLMY322..

PARAMETER	TEST CONDITION	SYMBOL	VALUE	UNIT
Reverse voltage ⁽¹⁾		V _R	5	V
Forward current		I _F	70	mA
Power dissipation	at RT	P _{tot}	225	mW
Junction temperature		T _j	125	°C
Operating temperature range		T _{amb}	- 40 to + 100	°C
Storage temperature range		T _{stg}	- 40 to + 100	°C
Thermal resistance junction/ambient	Mounted on PC board FR4	R _{thJA}	290	K/W

Note

⁽¹⁾ Driving the LED in reverse direction is suitable for short term application

**OPTICAL AND ELECTRICAL CHARACTERISTICS** ($T_{amb} = 25\text{ }^{\circ}\text{C}$, unless otherwise specified)
VLMS322.., SUPER RED

PARAMETER	TEST CONDITION	PART	SYMBOL	MIN.	TYP.	MAX.	UNIT
Luminous intensity ⁽¹⁾	$I_F = 50\text{ mA}$	VLMS322T2V1	I_V	355	450	900	mcd
Dominant wavelength	$I_F = 50\text{ mA}$		λ_d	625	630	640	nm
Spectral bandwidth at 50 % $I_{rel\ max.}$	$I_F = 50\text{ mA}$		$\Delta\lambda$	-	18	-	nm
Angle of half intensity	$I_F = 50\text{ mA}$		φ	-	± 60	-	deg
Forward voltage ⁽²⁾	$I_F = 50\text{ mA}$		V_F	1.7	2.1	2.6	V
Reverse current	$V_R = 5\text{ V}$		I_R	-	0.01	10	μA

Notes

- (1) In one packing unit $I_{Vmax.}/I_{Vmin.} \leq 1.6$
(2) Forward voltages are tested at a current pulse duration of 1 ms and a tolerance of $\pm 0.1\text{ V}$

OPTICAL AND ELECTRICAL CHARACTERISTICS ($T_{amb} = 25\text{ }^{\circ}\text{C}$, unless otherwise specified)
VLMK322.., AMBER

PARAMETER	TEST CONDITION	PART	SYMBOL	MIN.	TYP.	MAX.	UNIT
Luminous intensity ⁽¹⁾	$I_F = 50\text{ mA}$	VLMK322U1V2	I_V	450	750	1125	mcd
Dominant wavelength	$I_F = 50\text{ mA}$		λ_d	610	-	621	nm
Spectral bandwidth at 50 % $I_{rel\ max.}$	$I_F = 50\text{ mA}$		$\Delta\lambda$	-	18	-	nm
Angle of half intensity	$I_F = 50\text{ mA}$		φ	-	± 60	-	deg
Forward voltage ⁽²⁾	$I_F = 50\text{ mA}$		V_F	1.7	2.1	2.6	V
Reverse current	$V_R = 5\text{ V}$		I_R	-	0.01	10	μA

Notes

- (1) In one packing unit $I_{Vmax.}/I_{Vmin.} \leq 1.6$
(2) Forward voltages are tested at a current pulse duration of 1 ms and a tolerance of $\pm 0.1\text{ V}$

OPTICAL AND ELECTRICAL CHARACTERISTICS ($T_{amb} = 25\text{ }^{\circ}\text{C}$, unless otherwise specified)
VLMO322.., SOFT ORANGE

PARAMETER	TEST CONDITION	PART	SYMBOL	MIN.	TYP.	MAX.	UNIT
Luminous intensity ⁽¹⁾	$I_F = 50\text{ mA}$	VLMO322U1V2	I_V	450	750	1125	mcd
Dominant wavelength	$I_F = 50\text{ mA}$		λ_d	600	605	612	nm
Spectral bandwidth at 50 % $I_{rel\ max.}$	$I_F = 50\text{ mA}$		$\Delta\lambda$	-	18	-	nm
Angle of half intensity	$I_F = 50\text{ mA}$		φ	-	± 60	-	deg
Forward voltage ⁽²⁾	$I_F = 50\text{ mA}$		V_F	1.7	2.1	2.6	V
Reverse current	$V_R = 5\text{ V}$		I_R	-	0.01	10	μA

Notes

- (1) In one packing unit $I_{Vmax.}/I_{Vmin.} \leq 1.6$
(2) Forward voltages are tested at a current pulse duration of 1 ms and a tolerance of $\pm 0.1\text{ V}$

OPTICAL AND ELECTRICAL CHARACTERISTICS ($T_{amb} = 25\text{ }^{\circ}\text{C}$, unless otherwise specified)
VLMY322.., YELLOW

PARAMETER	TEST CONDITION	PART	SYMBOL	MIN.	TYP.	MAX.	UNIT
Luminous intensity ⁽¹⁾	$I_F = 50\text{ mA}$	VLMY322U1V2	I_V	450	750	1125	mcd
Dominant wavelength	$I_F = 50\text{ mA}$		λ_d	582	588	594	nm
Spectral bandwidth at 50 % $I_{rel\ max.}$	$I_F = 50\text{ mA}$		$\Delta\lambda$	-	18	-	nm
Angle of half intensity	$I_F = 50\text{ mA}$		φ	-	± 60	-	deg
Forward voltage ⁽²⁾	$I_F = 50\text{ mA}$		V_F	1.7	2.1	2.6	V
Reverse current	$V_R = 5\text{ V}$		I_R	-	0.01	10	μA

Notes

- (1) In one packing unit $I_{Vmax.}/I_{Vmin.} \leq 1.6$
(2) Forward voltages are tested at a current pulse duration of 1 ms and a tolerance of $\pm 0.1\text{ V}$

LUMINOUS INTENSITY CLASSIFICATION		
GROUP	LIGHT INTENSITY (mcd)	
STANDARD	MIN.	MAX.
T2	355	450
U1	450	560
U2	560	715
V1	715	900
V2	900	1125

Note

- Luminous intensity is tested at a current pulse duration of 25 ms and an accuracy of $\pm 11\%$.
The above type numbers represent the order groups which include only a few brightness groups. Only one group will be shipped on each reel (there will be no mixing of two groups on each reel). In order to ensure availability, single brightness groups will not be orderable. In a similar manner for colors where wavelength groups are measured and binned, single wavelength groups will be shipped on any one reel. In order to ensure availability, single wavelength groups will not be orderable.

COLOR CLASSIFICATION						
GROUP	YELLOW		SOFT ORANGE		AMBER	
	DOM. WAVELENGTH (nm)					
	MIN.	MAX.	MIN.	MIN.	MAX.	MAX.
W	582	585	600	603	610	615
X	585	588	603	606	615	621
Y	588	591	606	609		
Z	591	594	609	612		

Note

- Wavelengths are tested at a current pulse duration of 25 ms and an accuracy of ± 1 nm.

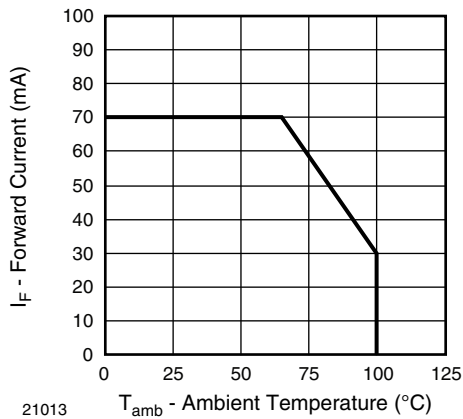
TYPICAL CHARACTERISTICS ($T_{amb} = 25\text{ }^{\circ}\text{C}$, unless otherwise specified)


Fig. 1 - Forward Current vs. Ambient Temperature

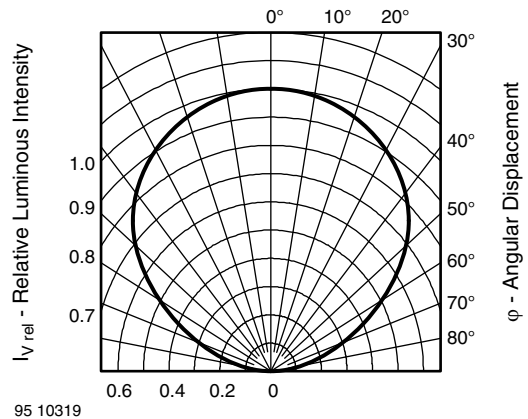


Fig. 2 - Relative Luminous Intensity vs. Angular Displacement

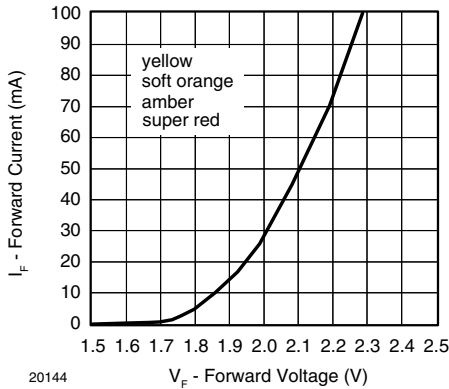


Fig. 3 - Relative Luminous Intensity vs. Forward Current

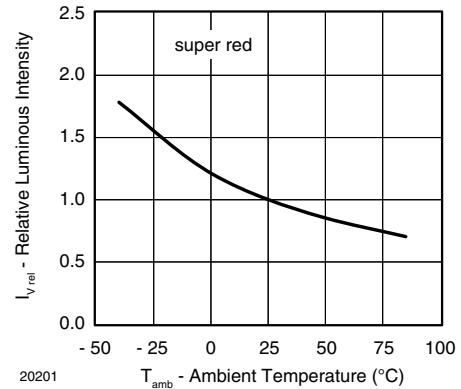


Fig. 6 - Relative Luminous Intensity vs. Ambient Temperature

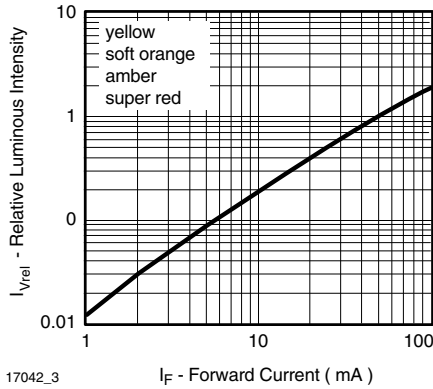


Fig. 4 - Relative Luminous Intensity vs. Forward Current

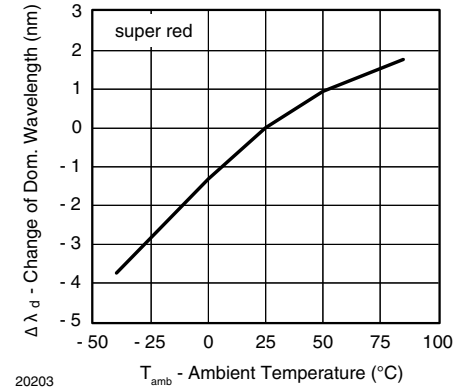


Fig. 7 - Change of Dominant Wavelength vs. Ambient Temperature

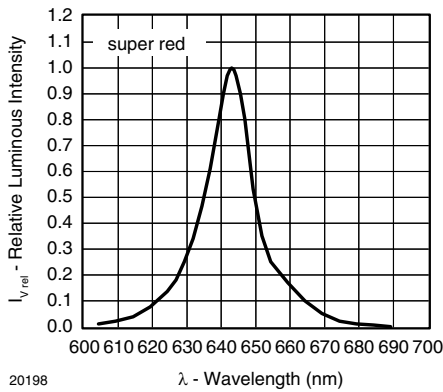


Fig. 5 - Relative Intensity vs. Wavelength

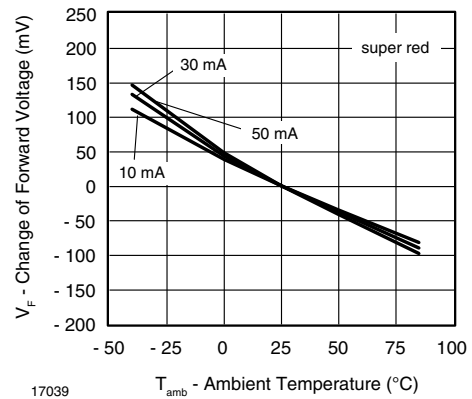


Fig. 8 - Change of Forward Voltage vs. Ambient Temperature

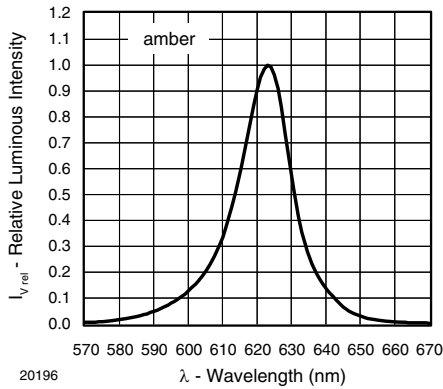


Fig. 9 - Relative Intensity vs. Wavelength

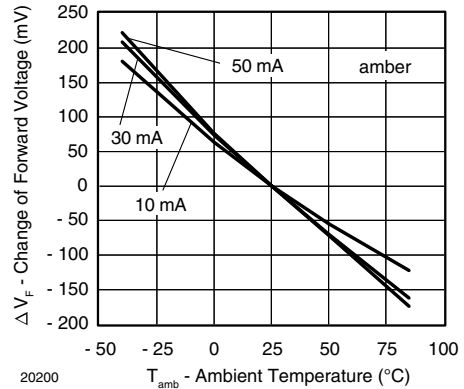


Fig. 12 - Change of Forward Voltage vs. Ambient Temperature

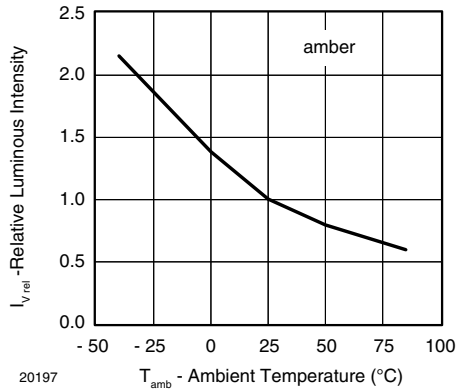


Fig. 10 - Relative Luminous Intensity vs. Ambient Temperature

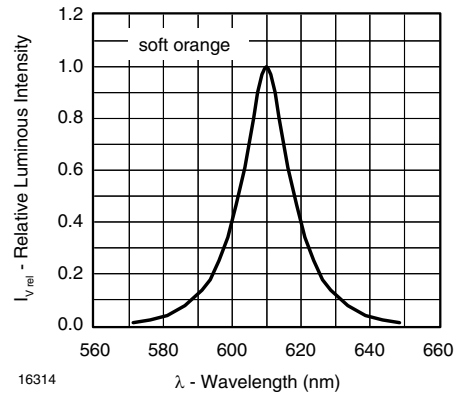


Fig. 13 - Relative Intensity vs. Wavelength

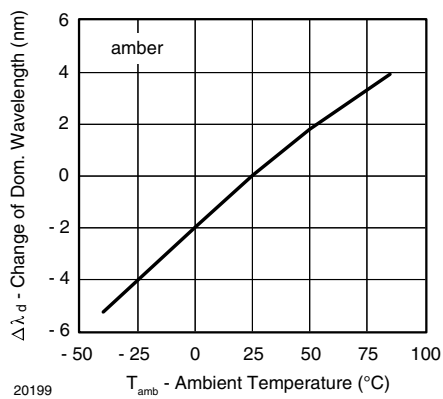


Fig. 11 - Change of Dominant Wavelength vs. Ambient Temperature

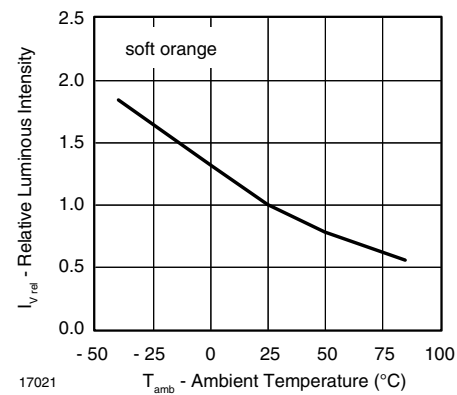


Fig. 14 - Relative Luminous Intensity vs. Ambient Temperature

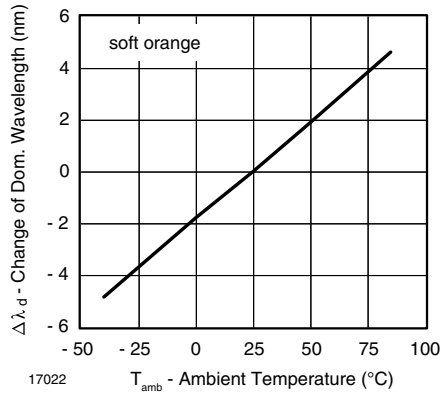


Fig. 15 - Change of Dominant Wavelength vs. Ambient Temperature

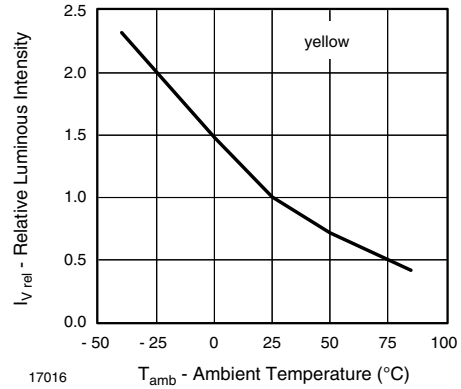


Fig. 18 - Relative Luminous Intensity vs. Ambient Temperature

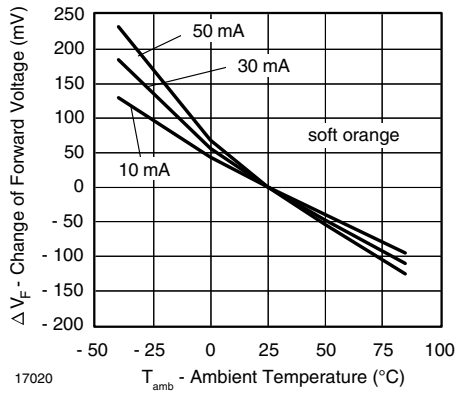


Fig. 16 - Change of Forward Voltage vs. Ambient Temperature

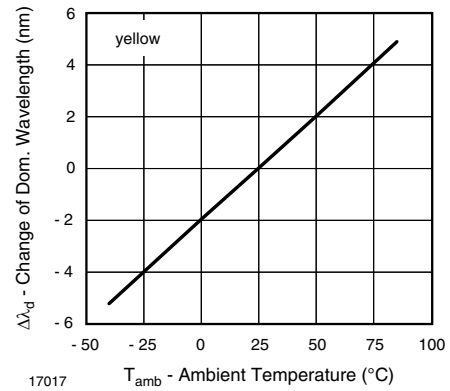


Fig. 19 - Relative Luminous Intensity vs. Ambient Temperature

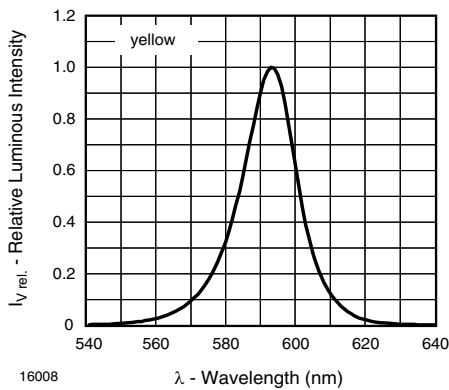


Fig. 17 - Relative Intensity vs. Wavelength

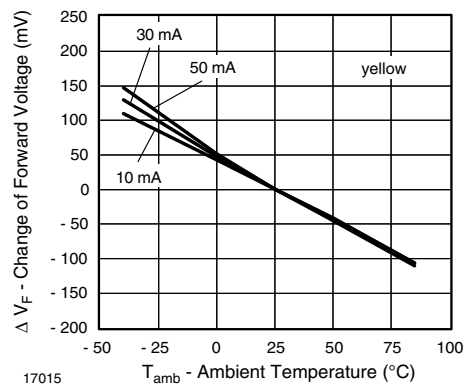
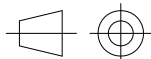
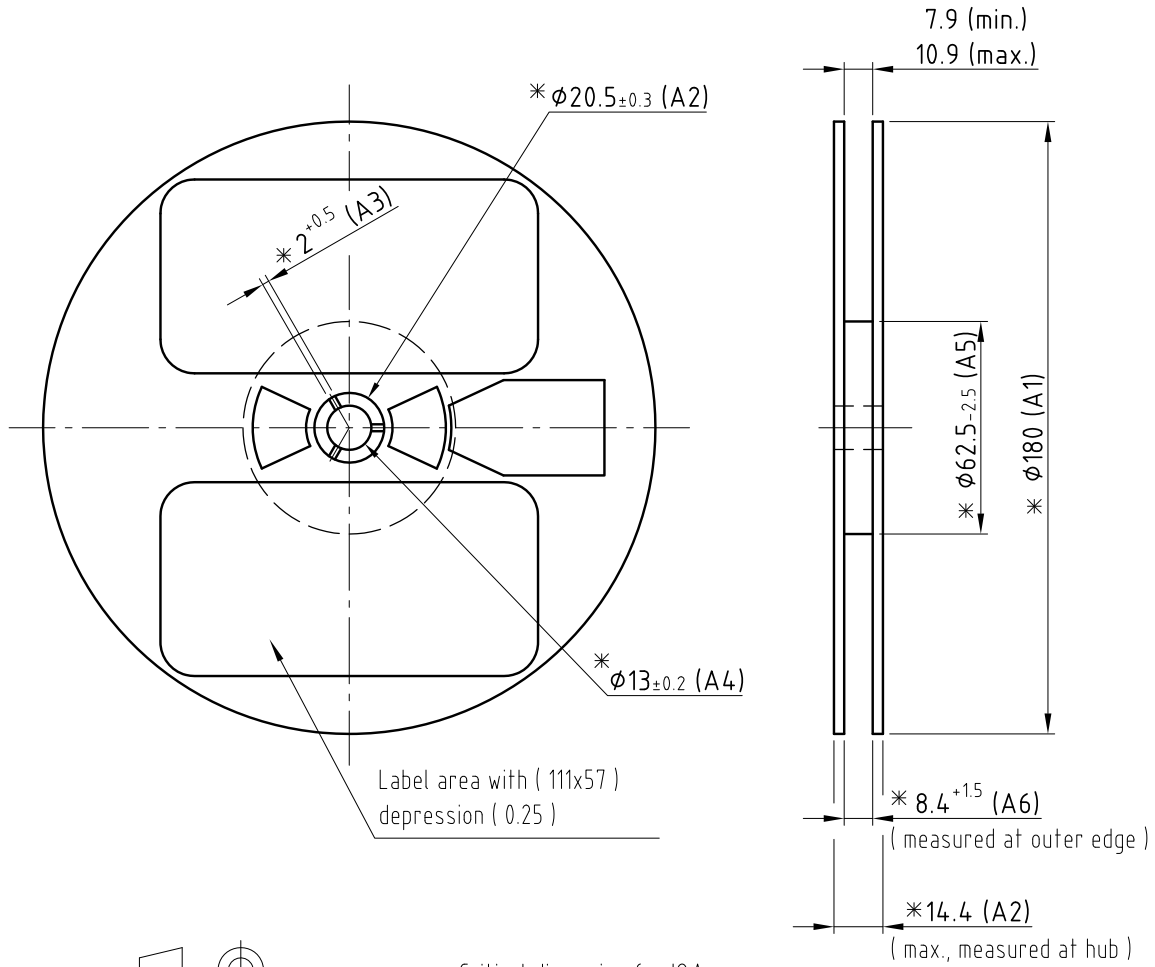


Fig. 20 - Change of Forward Voltage vs. Ambient Temperature



REEL DIMENSIONS in millimeters



technical drawings according to DIN specifications

\ast Critical dimension for IQA.

GS08 = 2000 pcs

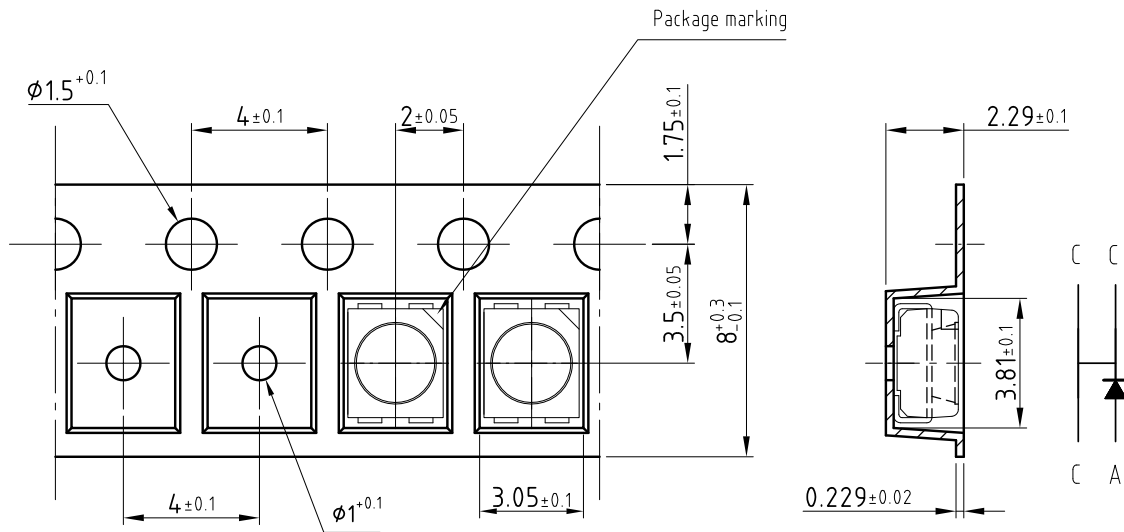
Not indicated tolerances ± 0.05
Material: black static dissipative

Drawing refers to following types: $\phi 180$ mm Plastic reel
Drawing-No.: 9.800-5086.01-4
Issue: 2; 05.05.08
20983

TAPING DIMENSIONS in millimeters

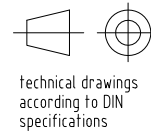
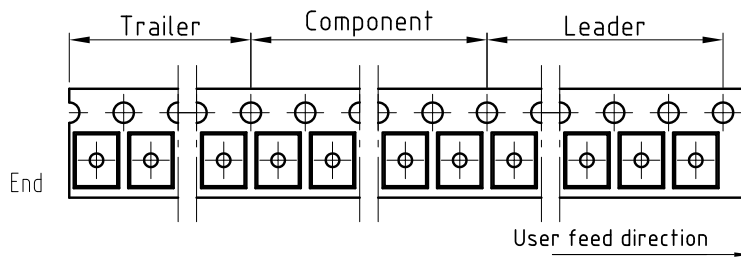
Taping and orientation

Reels come in quantity of 2000 units.



200mm min. for $\phi 180$ reel

480mm min. for $\phi 180$ reel



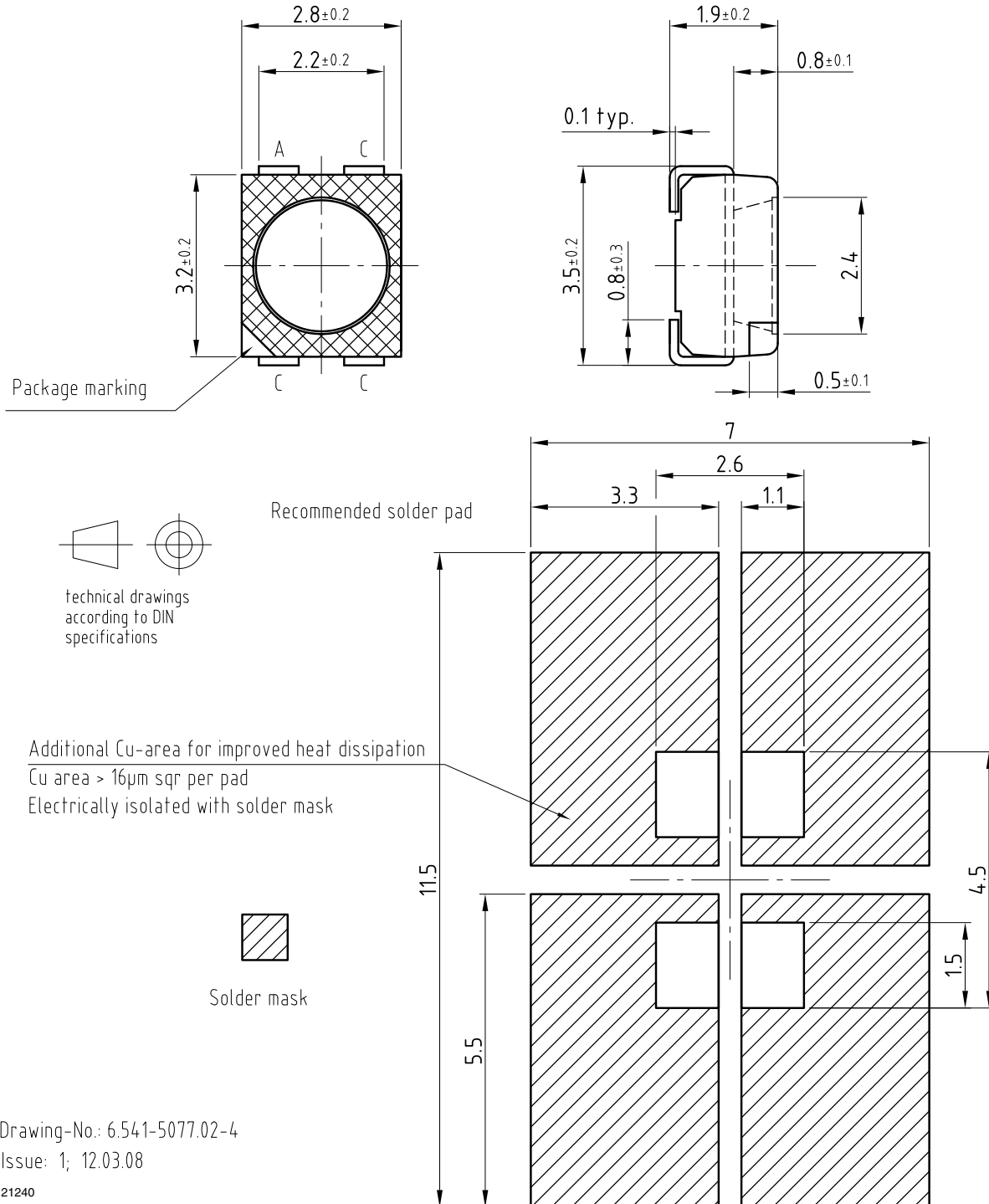
Drawing-No: 9.700-5334.02-4

Issue: 2; 07.04.08

21241



PACKAGE/SOLDERING PADS DIMENSIONS in millimeters



Drawing-No.: 6.541-5077.02-4

Issue: 1; 12.03.08

21240

SOLDERING PROFILE

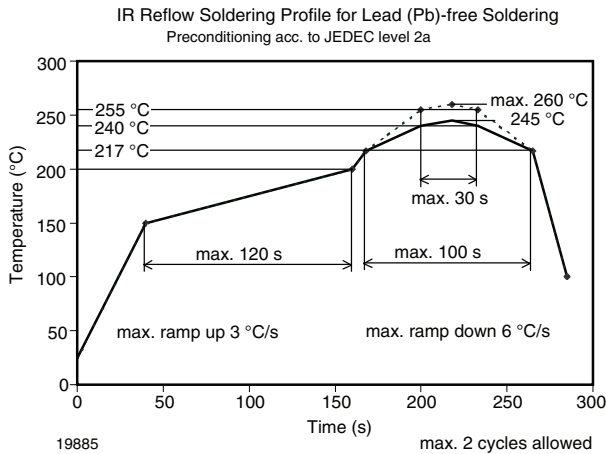


Fig. 21 - Vishay Lead (Pb)-free Reflow Soldering Profile (acc. to J-STD-020)

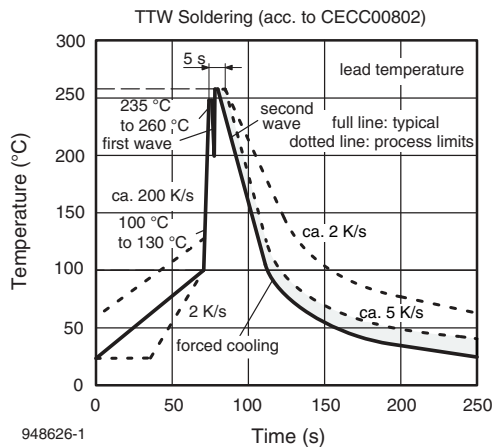
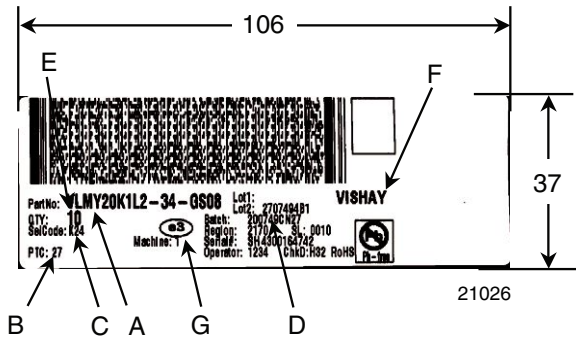


Fig. 22 - Double Wave Soldering of Opto Devices (all Packages)

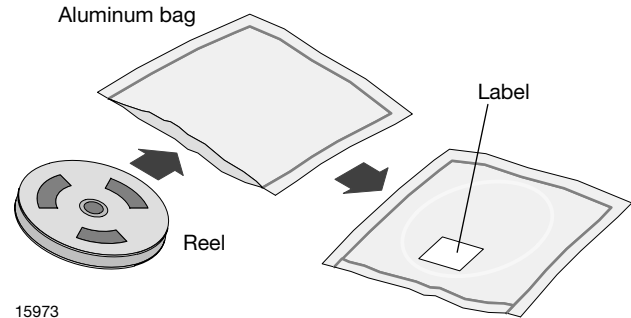
BAR CODE PRODUCT LABEL (example)



- A) Type of component
- B) PTC = manufacturing plant
- C) SEL - selection code (bin):
e.g.: K2 = code for luminous intensity group
4 = code for color group
- D) Batch/date code
- E) Total quantity
- F) Company code
- G) Code for lead (Pb)-free classification (e3)

DRY PACKING

The reel is packed in an anti-humidity bag to protect the devices from absorbing moisture during transportation and storage.



FINAL PACKING

The sealed reel is packed into a cardboard box. A secondary cardboard box is used for shipping purposes.



RECOMMENDED METHOD OF STORAGE

Dry box storage is recommended as soon as the aluminum bag has been opened to prevent moisture absorption. The following conditions should be observed, if dry boxes are not available:

- Storage temperature 10 °C to 30 °C
Storage humidity ≤ 60 % RH max.

After more than 672 h under these conditions moisture content will be too high for reflow soldering.

In case of moisture absorption, the devices will recover to the former condition by drying under the following condition:

- 192 h at 40 °C + 5 °C/- 0 °C and < 5 % RH (dry air/nitrogen) or
96 h at 60 °C + 5 °C and < 5 % RH for all device containers or
24 h at 100 °C + 5 °C not suitable for reel or tubes.

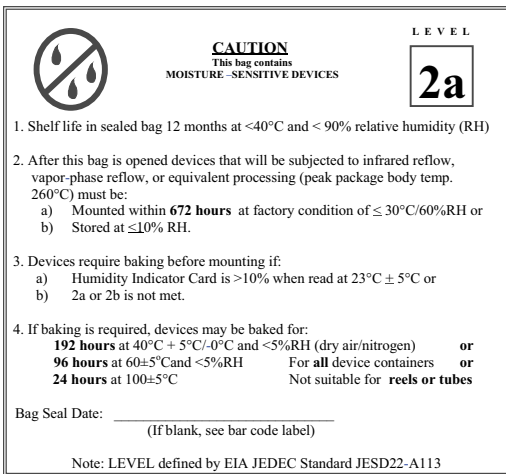
An EIA JEDEC standard JESD22-A112 level 2a label is included on all dry bags.

ESD PRECAUTION

Proper storage and handling procedures should be followed to prevent ESD damage to the devices especially when they are removed from the antistatic shielding bag. Electro-static sensitive devices warning labels are on the packaging.

VISHAY SEMICONDUCTORS STANDARD BAR CODE LABELS

The Vishay Semiconductors standard bar code labels are printed at final packing areas. The labels are on each packing unit and contain Vishay Semiconductors specific data.



Example of JESD22-A112 level 2a label



Disclaimer

ALL PRODUCT, PRODUCT SPECIFICATIONS AND DATA ARE SUBJECT TO CHANGE WITHOUT NOTICE TO IMPROVE RELIABILITY, FUNCTION OR DESIGN OR OTHERWISE.

Vishay Intertechnology, Inc., its affiliates, agents, and employees, and all persons acting on its or their behalf (collectively, "Vishay"), disclaim any and all liability for any errors, inaccuracies or incompleteness contained in any datasheet or in any other disclosure relating to any product.

Vishay makes no warranty, representation or guarantee regarding the suitability of the products for any particular purpose or the continuing production of any product. To the maximum extent permitted by applicable law, Vishay disclaims (i) any and all liability arising out of the application or use of any product, (ii) any and all liability, including without limitation special, consequential or incidental damages, and (iii) any and all implied warranties, including warranties of fitness for particular purpose, non-infringement and merchantability.

Statements regarding the suitability of products for certain types of applications are based on Vishay's knowledge of typical requirements that are often placed on Vishay products in generic applications. Such statements are not binding statements about the suitability of products for a particular application. It is the customer's responsibility to validate that a particular product with the properties described in the product specification is suitable for use in a particular application. Parameters provided in datasheets and/or specifications may vary in different applications and performance may vary over time. All operating parameters, including typical parameters, must be validated for each customer application by the customer's technical experts. Product specifications do not expand or otherwise modify Vishay's terms and conditions of purchase, including but not limited to the warranty expressed therein.

Except as expressly indicated in writing, Vishay products are not designed for use in medical, life-saving, or life-sustaining applications or for any other application in which the failure of the Vishay product could result in personal injury or death. Customers using or selling Vishay products not expressly indicated for use in such applications do so at their own risk. Please contact authorized Vishay personnel to obtain written terms and conditions regarding products designed for such applications.

No license, express or implied, by estoppel or otherwise, to any intellectual property rights is granted by this document or by any conduct of Vishay. Product names and markings noted herein may be trademarks of their respective owners.

Material Category Policy

Vishay Intertechnology, Inc. hereby certifies that all its products that are identified as RoHS-Compliant fulfill the definitions and restrictions defined under Directive 2011/65/EU of The European Parliament and of the Council of June 8, 2011 on the restriction of the use of certain hazardous substances in electrical and electronic equipment (EEE) - recast, unless otherwise specified as non-compliant.

Please note that some Vishay documentation may still make reference to RoHS Directive 2002/95/EC. We confirm that all the products identified as being compliant to Directive 2002/95/EC conform to Directive 2011/65/EU.

Vishay Intertechnology, Inc. hereby certifies that all its products that are identified as Halogen-Free follow Halogen-Free requirements as per JEDEC JS709A standards. Please note that some Vishay documentation may still make reference to the IEC 61249-2-21 definition. We confirm that all the products identified as being compliant to IEC 61249-2-21 conform to JEDEC JS709A standards.

Данный компонент на территории Российской Федерации

Вы можете приобрести в компании MosChip.

Для оперативного оформления запроса Вам необходимо перейти по данной ссылке:

<http://moschip.ru/get-element>

Вы можете разместить у нас заказ для любого Вашего проекта, будь то серийное производство или разработка единичного прибора.

В нашем ассортименте представлены ведущие мировые производители активных и пассивных электронных компонентов.

Нашей специализацией является поставка электронной компонентной базы двойного назначения, продукции таких производителей как XILINX, Intel (ex.ALTERA), Vicor, Microchip, Texas Instruments, Analog Devices, Mini-Circuits, Amphenol, Glenair.

Сотрудничество с глобальными дистрибьюторами электронных компонентов, предоставляет возможность заказывать и получать с международных складов практически любой перечень компонентов в оптимальные для Вас сроки.

На всех этапах разработки и производства наши партнеры могут получить квалифицированную поддержку опытных инженеров.

Система менеджмента качества компании отвечает требованиям в соответствии с ГОСТ Р ИСО 9001, ГОСТ РВ 0015-002 и ЭС РД 009

Офис по работе с юридическими лицами:

105318, г.Москва, ул.Щербаковская д.3, офис 1107, 1118, ДЦ «Щербаковский»

Телефон: +7 495 668-12-70 (многоканальный)

Факс: +7 495 668-12-70 (доб.304)

E-mail: info@moschip.ru

Skype отдела продаж:

moschip.ru

moschip.ru_4

moschip.ru_6

moschip.ru_9