LIN Transceiver with Voltage Regulator

Features

- The MCP2021/2/1P/2P are compliant with LIN Bus Specifications 1.3, 2.0, and 2.1 and are compliant to SAE J2602
- Support Baud Rates up to 20 Kbaud with LIN-compatible output driver
- 43V Load dump protected
- Very low EMI meets stringent OEM requirements
- Wide supply voltage, 6.0V - 18.0V continuous:
 - Maximum input voltage of 30V
- Extended Temperature Range: -40 to +125°C
- Interface to PIC EUSART and standard USARTs
- Local Interconnect Network (LIN) bus pin:
 - Internal pull-up resistor and diode
 - Protected against ground shorts
 - Protected against loss of ground
 - High current drive
- Automatic thermal shutdown
- On-Chip Voltage Regulator:
 - Output voltage of 5.0V with tolerances of $\pm 3\%$ overtemperature range
 - Available with alternate output voltage of 3.3V with tolerances of $\pm 3\%$ overtemperature range
 - Maximum continuous input voltage of 30V
 - Internal thermal overload protection
 - Internal short circuit current limit
 - External components limited to filter capacitor only and load capacitor
- Two low-power modes:
 - Receiver on, Transmitter off, voltage regulator on ($\cong 85 \mu\text{A}$)
 - Receiver monitoring bus, Transmitter off, voltage regulator off ($\cong 16 \mu\text{A}$)

Description

The MCP2021/2/1P/2P provides a bidirectional, half-duplex communication physical interface to automotive and industrial LIN systems that meets the LIN bus specification Revision 2.0. The devices incorporate a voltage regulator with 5V at 50 mA or 3.3V at 50 mA regulated power-supply outputs.

The regulator is short-circuit protected, and is protected by an internal thermal shutdown circuit. The device has been specifically designed to operate in the automotive operating environment and will survive all specified transient conditions while meeting all of the stringent quiescent current requirements.

The MCP2021/2/1P/2P family of devices includes the following packages.

8-pin PDIP, DFN and SOIC packages:

- MCP2021-330, LIN-compatible driver, 8-pin, 3.3V regulator, wake up on dominant level of L_{BUS}
- MCP2021-500, LIN-compatible driver, 8-pin, 5.0V regulator, wake up on dominant level of L_{BUS}
- MCP2021P-330, LIN-compatible driver, 8-pin, 3.3V regulator, wake up at falling edge of L_{BUS} voltage
- MCP2021P-500, LIN-compatible driver, 8-pin, 5.0V regulator, wake up at falling edge of L_{BUS} voltage

14-pin PDIP, TSSOP and SOIC packages with $\overline{\text{RESET}}$ output:

- MCP2022-330, LIN-compatible driver, 14-pin, 3.3V regulator, RESET output, wake up on dominant level of L_{BUS}
- MCP2022-500, LIN-compatible driver, 14-pin, 5.0V regulator, RESET output, wake up on dominant level of L_{BUS}
- MCP2022P-330, LIN-compatible driver, 14-pin, 3.3V regulator, RESET output, wake up at falling edge of L_{BUS} voltage
- MCP2022P-500, LIN-compatible driver, 14-pin, 5.0V regulator, RESET output, wake up at falling edge of L_{BUS} voltage



MCP2021/2/1P/2P

Package Types



MCP2021/2 Block Diagram



MCP2021P/2P Block Diagram



MCP2021/2/1P/2P

NOTES:

1.0 DEVICE OVERVIEW

The MCP2021/2/1P/2P provides a physical interface between a microcontroller and a LIN half-duplex bus. It is intended for automotive and industrial applications with serial bus speeds up to 20 Kbaud.

The MCP2021/2/1P/2P provides a half-duplex, bidirectional communications interface between a microcontroller and the serial network bus. This device will translate the CMOS/TTL logic levels to LIN-level logic, and vice versa.

The LIN specification 2.0 requires that the transceiver(s) of all nodes in the system be connected via the LIN pin, referenced to ground, and with a maximum external termination resistance load of 510Ω from LIN bus to battery supply. The 510Ω corresponds to 1 Master and 16 Slave nodes.

The MCP2021/2/1P/2P-500 provides a +5V, 50 mA, regulated power output. The regulator uses an LDO design, is short-circuit protected, and will turn the regulator output off if it falls below 3.5V.

The MCP2021/2/1P/2P also includes thermal-shutdown protection.

The regulator is specifically designed to operate in the automotive environment and will survive +43V load dump transients, double-battery jumps, and reverse battery connections when a reverse blocking diode is used. The other members of the MCP2021/2/1P/2P-330 family output +3.3V at 50 mA with a turn-off voltage of 2.5V. (See [Section 1.6 “Internal Voltage Regulator”](#)).

MCP2021/2 wakes from Power-Down mode on a dominant level on LBUS. MCP2021P/2P wakes at a transition from recessive level to dominant level on LBUS.

1.1 Optional External Protection

1.1.1 REVERSE BATTERY PROTECTION

An external reverse-battery-blocking diode should be used to provide polarity protection (see [Figure 1-6](#)).

1.1.2 TRANSIENT VOLTAGE PROTECTION (LOAD DUMP)

An external 43V transient suppressor (TVS) diode, between V_{BB} and ground, with a 50Ω transient protection resistor (RTP) in series with the battery supply and the V_{BB} pin protect the device from power transients (see [Figure 1-6](#)) and ESD events. While this protection is optional, it is considered good engineering practice. The resistor value is chosen according to [Equation 1-1](#).

EQUATION 1-1:

$$RTP \leq (V_{BB_{min}} - 5.5) / 250 \text{ mA.}$$
$$5.5V = V_{UVLO} + 1.0V,$$

250 mA is the peak current at Power-On when

$$V_{BB} = 5.5V$$

1.2 Internal Protection

1.2.1 ESD PROTECTION

For component-level ESD ratings, please refer to the [Section 2.1 “Absolute Maximum Ratings†”](#).

1.2.2 GROUND LOSS PROTECTION

The LIN Bus specification states that the LIN pin must transition to the recessive state when ground is disconnected. Therefore, a loss of ground effectively forces the LIN line to a hi-impedance level.

1.2.3 THERMAL PROTECTION

The thermal protection circuit monitors the die temperature and is able to shut down the LIN transmitter and voltage regulator if it detects a thermal overload.

There are three causes for a thermal overload. A thermal shut down can be triggered by any one, or a combination of, the following thermal overload conditions:

- Voltage regulator overload
- LIN bus output overload
- Increase in die temperature due to increase in environmental temperature

Driving the TXD and checking the RXD pin makes it possible to determine whether there is a bus contention (i.e., Rx = low, Tx = high) or a thermal overload condition (i.e., Rx = high, Tx = low).

MCP2021/2/1P/2P

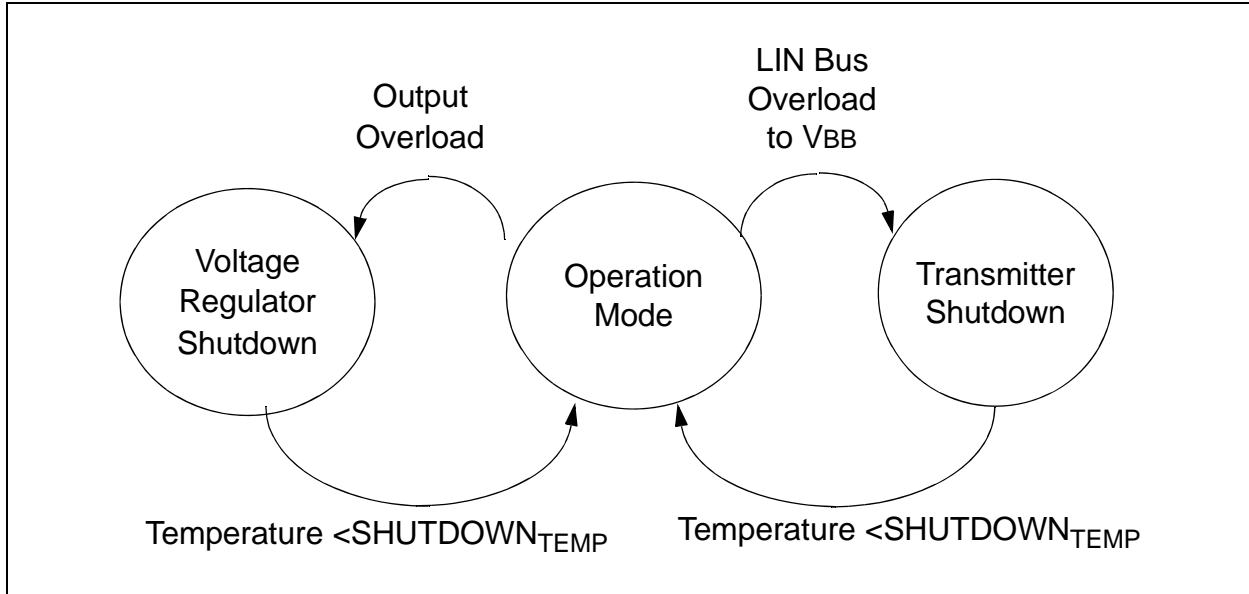

FIGURE 1-1: Thermal Shutdown State Diagrams.

1.3 Modes of Operation

For an overview of all operational modes, please refer to [Table 1-1](#).

1.3.1 POWER-ON RESET MODE

Upon application of V_{BB} , the device enters Power-on Reset mode (POR). During this mode, the part maintains the digital section in a Reset mode and waits until the voltage on pin V_{BB} rises above the “ON” threshold (Typ. 5.75V) to enter to the Ready mode. If during the operation, the voltage on pin V_{BB} falls below the “OFF” threshold (Typ. 4.25V), the part comes back to the POR mode.

1.3.2 POWER-DOWN MODE

In the Power-Down mode, the transmitter and the voltage regulator are off. Only the receiver wake-up from LIN bus section, and the CS/LWAKE pin wake-up circuits are in operation. This is the lowest power mode.

If pin CS/LWAKE goes to a high level during Power-Down mode, the device immediately enters Ready mode and enables the voltage regulator; and after the output has stabilized (approximately 0.3 ms to 1.2 ms), the device goes to Operation mode or Transmitter-Off mode (see [Figure 1-2](#) for MCP2021/2 and [Figure 1-3](#) for MCP2021P/2P).

Note: The above time interval <math><1.2\text{ ms}</math> assumes 12V V_{BB} input and no thermal shutdown event.

LIN bus activity will also change the device from Power-Down mode to Ready mode. MCP2021/2 wakes up on dominant level of LIN bus, and MCP2021P/2P on a falling edge that follows a dominant level lasting 20 μs of time.

The Power-Down mode can be reached through either Operation mode or Transmitter-Off mode.

1.3.3 READY MODE

Upon entering Ready mode, the voltage regulator and receiver-threshold-detect circuit are powered up. The transmitter remains in off state. The device is ready to receive data as soon as the regulator is stabilized, but not to transmit. If a microcontroller is being driven by the voltage regulator output, it will go through a POR and initialization sequence. The LIN pin is in the recessive state for MCP2021/2 and in floating state for MCP2021P/2P.

The device will stay in Ready mode until the output of the voltage regulator has stabilized and the CS/LWAKE pin is true ('1'). After V_{REG} is stable and CS/LWAKE is high, MCP2021/2 will enter Operation mode; and MCP2021P/2P will enter either Operation mode or Transmitter-Off mode, depending on the level of the $\overline{\text{FAULT}}/\text{TXE}$ pin (refer to [Figure 1-3](#)).

1.3.4 OPERATION MODE

In this mode, all internal modules are operational.

The device will go into the Power-Down mode on the falling edge of CS/LWAKE.

For the MCP2021P/2P devices, the pull-up resistor is switched on only in this mode.

1.3.5 TRANSMITTER-OFF MODE

Whenever the $\overline{\text{FAULT}}/\text{TXE}$ signal is low, or permanent dominant on TXD/LBUS is detected, the LBUS transmitter is off.

The transmitter may be re-enabled whenever the $\overline{\text{FAULT}}/\text{TXE}$ signal returns high, either by removing the internal fault condition or when the CPU returning the $\overline{\text{FAULT}}/\text{TXE}$ high. The transmitter will not be enabled if the $\overline{\text{FAULT}}/\text{TXE}$ pin is brought high when the internal fault is still present.

If TX-OFF mode is caused by TXD/LBUS permanent dominant level, the transmitter can recover when the permanent dominant status disappears.

The transmitter is also turned off whenever the voltage regulator is unstable or recovering from a fault. This prevents unwanted disruption of the bus during times of uncertain operation.

1.3.6 WAKE-UP

The Wake-Up sub-module observes the LBUS in order to detect bus activity. Bus activity is detected when the voltage on the LBUS stays below a threshold of approximately $0.4V_{\text{BB}}$ for at least a typical duration of 20 μs . The MCP2021/2 device is level sensitive to LBUS. Dominant level longer than 20 μs will cause the device to leave the Power-Down mode. The MCP2021P/2P device is falling-edge sensitive to LBUS. Only the LBUS transition from recessive to dominant followed by at least 20 μs dominant level can wake up the device. Putting CS/LWAKE to high level also wakes up the device. Refer to [Figure 1-2](#) and [Figure 1-3](#).

1.3.7 DIFFERENCE DETAILS BETWEEN MCP2021/2 AND MCP2021P/2P

The MCP202xP is a minor variation of the MCP202x device that adds improved state machine control as well as the ability to disconnect the internal 30k Ω pull-up between LIN and VBB in all modes except normal operation. These changes allow the system designer to better handle fault conditions and reduce the overall system current consumption. The differences between the two device versions are as follows:

1. Switchable LIN-VBB Pull-Up Resistor:

On the MCP202xP device, the internal 30k Ω pull-up resistor is disconnected in all modes except Operation Mode. On the MCP202x device, this pull-up resistor is always connected. (See the [MCP2021/2 Block Diagram](#) and the [MCP2021P/2P Block Diagram](#) for details.)

2. Power Down Wake-up on LIN Traffic:

The MCP202xP device requires a LIN falling edge to generate a valid Wake condition due to bus traffic. The MCP202x device will generate a Wake anytime LIN is at a valid dominant level.

Because of this, if the LIN bus becomes permanently shorted, it becomes impossible to place the MCP202x in a low power state.

3. State Machine Options:

The MCP202xP device is able to enter Transmitter Off Mode from Ready Mode without transitioning through Operation Mode. The MCP202x device must enter Operation Mode from Ready Mode. (See State Machine Diagrams, [Figure 1-2](#) and [Figure 1-3](#) for details). This capability allows the system designer to monitor the bus in Ready Mode to determine if the system should transition to normal operation and connect the internal pull-up or if Ready Mode was reached due to an invalid condition. In the case of an invalid condition, the MCP202xP device can be placed into Power Down mode without connecting the internal pull-up and waking other nodes on the LIN Bus network.

Note: To enter Transmitter Off, the system must set TXE 'low' before pulling CS high (see Figure 1-5). Otherwise, if CS is pulled high first, the MCP202xP will enter Operation Mode due to the internal pull-up on TXE.
--

To properly take advantage of the device differences will require the system designer to implement some microcontroller code to the power-up routine. This code will monitor the status of the LIN bus to determine how the dominant signal should be responded to. It will also determine if the local LIN node needs to respond or can 'Listen Only'. If the local LIN node does not need to respond, it can enter Transmitter Off Mode, disconnecting the 30k Ω pull-up, reducing module current while still maintaining the ability to properly receive all valid LIN messages.

MCP2021/2/1P/2P



FIGURE 1-2: MCP2021/2 Operational Modes State Diagrams.

Note: While the device is in shutdown, TXD should not be actively driven high or it may power internal logic through the ESD diodes and may damage the device.



FIGURE 1-3: MCP2021P/2P Operational Modes State Diagrams.



FIGURE 1-4: MCP2021P/2P Wake-Up Due to Bus Disconnecting.

MCP2021/2/1P/2P



FIGURE 1-5: Forced Power-Down Mode Sequence for MCP2021P/2P.

TABLE 1-1: OVERVIEW OF OPERATIONAL MODES

State	Transmitter	Receiver	Voltage Regulator	Operation	Comments
POR	OFF	OFF	OFF	Read VBB; if VBB>5.75V, enter Ready mode	
Ready	OFF	ON	ON	<p>MCP2021/2: If CS/LWAKE is high level, then Operation mode.</p> <p>MCP2021P/2P: If CS/LWAKE is high level and $\overline{\text{FAULT/TXE}}$ is high level, then Operation mode. If CS/LWAKE is high level and $\overline{\text{FAULT/TXE}}$ is low level, then TXOFF mode.</p>	Bus Off state
Operation	ON	ON	ON	<p>If CS/LWAKE is low level, then Power-Down mode.</p> <p>If $\overline{\text{FAULT/TXE}}$ is low level or TXD/LBUS permanent dominant is detected, then Transmitter-Off mode.</p>	Normal Operation mode
Power-Down	OFF	Activity Detect	OFF	On LIN bus falling, go to Ready mode. On CS/LWAKE high level, go through Ready mode; then, to either operation or Transmitter-Off mode (refer to Figure 1-2 and Figure 1-3).	Low Power mode
Transmitter-Off	OFF	ON	ON	<p>If CS/LWAKE is low level, then Power-Down mode.</p> <p>If $\overline{\text{FAULT/TXE}}$ is high, then Operation mode.</p>	

MCP2021/2/1P/2P

1.4 Pin Descriptions

TABLE 1-1: PINOUT DESCRIPTIONS

Pin Name	Devices		Pin Type	Function
	8-Pin DFN, PDIP, SOIC	14-Pin PDIP, SOIC, TSSOP		Normal Operation
VREG	3	3	O	Power Output
VSS	5	11	P	Ground
VBB	7	13	P	Battery Supply
TXD	4	4	I	Transmit Data Input (TTL)
RXD	1	1	O	Receive Data Output (CMOS)
LBUS	6	12	I/O	LIN bus (bidirectional)
CS/LWAKE	2	2	TTL	Chip Select (TTL)
$\overline{\text{FAULT}}/\text{TXE}$	8	14	OD	Fault Detect Output, Transmitter Enable (OD)
$\overline{\text{RESET}}$	—	5	OD	$\overline{\text{RESET}}$ signal Output (OD)

Legend: O = Output, P = Power, I = Input, TTL = TTL input buffer, OD = Open-Drain output

1.4.1 POWER OUTPUT (VREG)

Positive Supply Voltage Regulator Output pin.

1.4.2 GROUND (VSS)

Ground pin.

1.4.3 BATTERY (VBB)

Battery Positive Supply Voltage pin. This pin is also the input for the internal voltage regulator.

1.4.4 TRANSMIT DATA INPUT (TXD)

The Transmit Data Input pin has an internal pull-up to VREG. The LIN pin is low (dominant) when TXD is low, and high (recessive) when TXD is high.

For extra bus security, TXD is internally forced to '1' when VREG is less than 1.8V (typ.).

If the thermal protection detects an over-temperature condition while the signal TXD is low, the transmitter is shut down. The recovery from the thermal shutdown is equal to adequate cooling time.

1.4.5 RECEIVE DATA OUTPUT (RXD)

The Receive Data Output pin is a standard CMOS output and follows the state of the LIN pin.

1.4.6 LIN BUS

The bidirectional LIN bus Interface pin is the driver unit for the LIN pin and is controlled by the signal TXD. LIN has an open collector output with a current limitation. To reduce EMI, the edges during the signal changes are slope-controlled. To further reduce radiated emissions, the LBUS pin has corner-rounding control for both falling and rising edges.

The internal LIN receiver observes the activities on the LIN bus, and generates output signal RXD that follows the state of the LBUS. A 1st degree with 1 μ S time constant (160KhZ), low-pass input filter is placed to maintain EMI immunity.

1.4.7 CS/LWAKE

Chip Select Input pin. A internal pull-down resistor will keep the CS/LWAKE pin low. This is done to ensure that no disruptive data will be present on the bus while the microcontroller is executing a POR and I/O initialization sequence. The pin must see a high level to activate the transmitter.

If CS/LWAKE = '0' when the VBB supply is turned on, the device stays in Ready mode (Low-Power mode). In Ready mode, both the receiver and the voltage regulator are on and the LIN transmitter driver is off.

If CS/LWAKE = '1' when the VBB supply is turned on, the device will proceed to either Operation or Transmitter-Off mode (refer to [Figure 1-2](#) and [Figure 1-3](#)) after the VREG output has stabilized.

This pin may also be used as a local wake-up input (see [Figure 1-6](#)). In this implementation, the microcontroller will set the I/O pin that controls the CS/LWAKE as an high-impedance input. The internal pull-down resistor will keep the input low. An external switch, or other source, can then wake up the transceiver and the microcontroller.

Note: CS/LWAKE should not be tied directly to VREG as this could force the MCP202x into Operation mode before the microcontroller is initialized.

1.4.8 $\overline{\text{FAULT/TXE}}$

Fault Detect Output and Transmitter Enable Input bidirectional pin.

This pin is an open-drain output. Its state is defined as shown in [Table 1-2](#). The transmitter driver is disabled whenever this pin is low ('0'), either from an internal fault condition or by external drive. This allows the transmitter to be placed in an off state and still allow the voltage regulator to operate. Refer to [Table 1-1](#).

The $\overline{\text{FAULT/TXE}}$ also signals a mismatch between the TXD input and the L_{BUS} level. This can be used to detect a bus contention. Since the bus exhibits a propagation delay, the sampling of the internal compare is debounced to eliminate false faults.

This pin has an internal pull-up resistor of approximately 750 k Ω .

- Note 1:** The $\overline{\text{FAULT/TXE}}$ pin is true (0) whenever the internal circuits have detected a short or thermal excursion and have disabled the L_{BUS} output driver.
- 2:** $\overline{\text{FAULT/TXE}}$ is true (0) when V_{REG} not OK and has disabled the L_{BUS} output driver.

The $\overline{\text{FAULT/TXE}}$ pin sampled at a rate faster than every 10 μs .

TABLE 1-2: $\overline{\text{FAULT/TXE}}$ TRUTH TABLE

TXD In	RXD Out	LIN _{BUS} I/O	Thermal Override	$\overline{\text{FAULT/TXE}}$		Definition
				External Input	Driven Output	
L	H	V _{BB}	OFF	H	L	FAULT , TXD driven low, LIN _{BUS} shorted to V _{BB} (Note 1)
H	H	V _{BB}	OFF	H	H	OK
L	L	GND	OFF	H	H	OK
H	L	GND	OFF	H	H	OK , data is being received from the LIN _{BUS}
x	x	V _{BB}	ON	H	L	FAULT , transceiver in thermal shutdown
x	x	V _{BB}	x	L	x	NO FAULT , the CPU is commanding the transceiver to turn off the transmitter driver

Legend: x = don't care

Note 1: The $\overline{\text{FAULT/TXE}}$ is valid after approximately 25 μs after TXD falling edge. This is to eliminate false fault reporting during bus propagation delays.

1.4.9 $\overline{\text{RESET}}$

$\overline{\text{RESET}}$ is an open-drain output pin. This pin reflects an internal signal that tracks the internal system voltage has reached a valid, stable level.

As long as the internal voltage is valid, this pin will keep high impedance. When the system voltage drops below the minimum required, the voltage regulator will shut down and immediately convert the $\overline{\text{RESET}}$ output to short to GND. A pull-up resistor is needed to change the output to high/low voltage. When connected to a micro-controller input, this can provide a warning that the voltage regulator is shutting down (see [Figure 1-2](#)).

Alternately, it can act as an external brown-out by connecting the $\overline{\text{RESET}}$ output to MCLR (see [Figure 1-2](#)). In addition to monitoring the internal voltage, $\overline{\text{RESET}}$ is asserted immediately upon entering the Power-Down mode.

MCP2021/2/1P/2P

1.5 Typical Applications



FIGURE 1-6: Typical MCP2021/MCP2021P Application.



FIGURE 1-7: Typical MCP2022/MCP2022P Application.



FIGURE 1-8: Typical LIN Network Configuration.

MCP2021/2/1P/2P

1.6 Internal Voltage Regulator

1.6.1 5.0V REGULATOR

The MCP2021 has a low-drop-out voltage, positive regulator capable of supplying 5.00 V_{DC} ±3% at up to 50 mA of load current over the entire operating temperature range of -40°C to +125°C. With a load current of 50 mA, the minimum input to output voltage differential required for the output to remain in regulation is typically +0.5V (+1V maximum over the full operating temperature range). Quiescent current is less than 100 µA with a full 50 mA load current when the input to output voltage differential is greater than +3.00V.

The regulator requires an external output bypass capacitor for stability. See [Figure 2-3](#) for correct capacity and ESR for stable operation.

Designed for automotive applications, the regulator will protect itself from double-battery jumps and up to +43V load dump transients. The voltage regulator has both short-circuit and thermal-shut-down protection built in.

Regarding the correlation between V_{BB}, V_{REG} and I_{DD}, please refer to [Figure 1-10](#) through [Figure 1-12](#). When the input voltage (V_{BB}) drops below the differential needed to provide stable regulation, the output V_{REG} will track the input down to approximately 3.5V, at which point the regulator will turn off. This will allow microcontrollers with internal POR circuits to generate a clean arming of the POR trip point. The MCP2021 will then monitor V_{BB} and turn on the regulator when V_{BB} rises above 5.75, again.

When the input voltage (V_{BB}) drops below the differential needed to provide stable regulation, the output (V_{REG}) will track the input down to approximately +4.25V. The regulator will turn off the output at this point. This will allow PIC[®] microcontrollers with internal POR circuits to generate a clean arming of the POR trip point. The regulator output will stay off until V_{BB} is above +5.75 V_{DC}.

In the start phase, the device must detect at least 5.75V to initiate operation during power up. In the Power-Down mode, the V_{BB} monitor will be turned off.

Note: The regulator has an overload current limiting of approximately 100 mA. During a short circuit, the V_{REG} is monitored. If V_{REG} is lower than 3.5V, the V_{REG} will turn off. After a recovery time of about three milliseconds, the V_{REG} will be checked again. If there is no short circuit (V_{REG} >3.5V), the V_{REG} will be switched back on.

The regulator has a thermal shutdown. If the thermal protection circuit detects an overtemperature condition, and the signals TXD and RXD are LOW, or TXD is HIGH, the regulator will shut down. The recovery from the thermal shutdown is equal to adequate cooling time.



FIGURE 1-9: Voltage Regulator Block Diagram.

1.6.2 3.3V REGULATOR

A metal option provides for an alternate 3.30 VDC $\pm 3\%$ at up to 50 mA of load current over the entire operating temperature range of -40°C to $+125^{\circ}\text{C}$. All specifications given above for the 5.0V operation apply except for any difference noted here.

The same input tracking of 4.25V applies the 3.3V regulator.

Note: The regulator has an overload current limiting of approximately 100 mA. If V_{REG} is lower than 2.5V, the V_{REG} will turn off.



FIGURE 1-10: Voltage Regulator Output on POR.

MCP2021/2/1P/2P

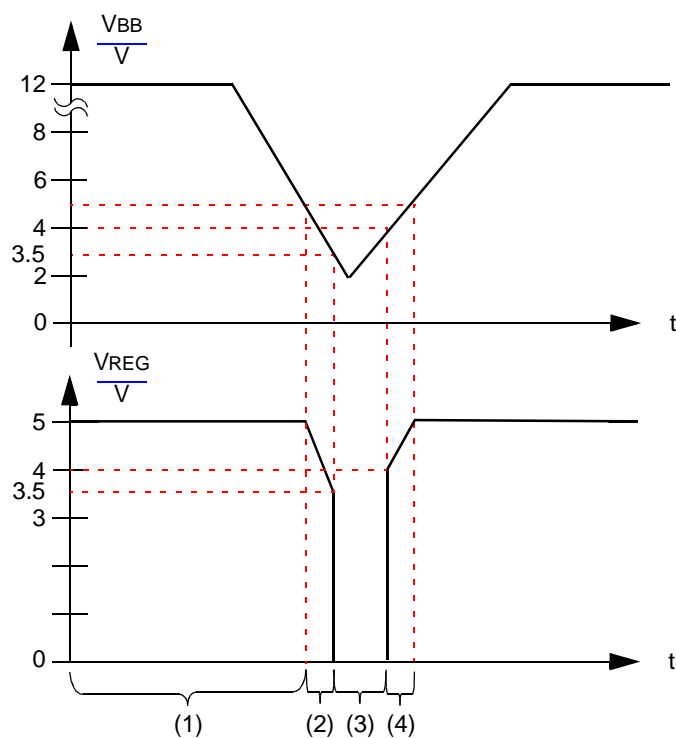

- Note 1:** Voltage regulator on.
2: $V_{BB} \leq 5.5V$, regulator tracks V_{BB} until $V_{BB} < 4.25V$.
3: $V_{REG} < 3.5V$, regulator is off.
4: $V_{BB} > 5.75V$, regulator on.

FIGURE 1-11: Voltage Regulator Output on Power Dip.



FIGURE 1-12: Voltage Regulator Output on Overcurrent Situation.

1.7 ICSP™ Considerations

The following should be considered when the MCP2021/2/1P/2P is connected to pins supporting in-circuit programming:

- Power used for programming the microcontroller can be supplied from the programmer or from the MCP2021/2/1P/2P.
- The voltage on V_{REG} should not exceed the maximum output voltage of V_{REG} .

MCP2021/2/1P/2P

NOTES:

2.0 ELECTRICAL CHARACTERISTICS

2.1 Absolute Maximum Ratings†

V _{IN} DC Voltage on RXD and TXD	-0.3 to V _{REG} +0.3V
V _{IN} DC Voltage on $\overline{\text{FAULT}}$ and $\overline{\text{RESET}}$	-0.3 to +5.5V
V _{IN} DC Voltage on CS/LWAKE.....	-0.3 to +43V
V _{BB} Battery Voltage, non-operating (LIN bus recessive, no regulator load, t < 60s)	-0.3 to +43V
V _{BB} Battery Voltage, transient ISO 7637 Test 1	-200V
V _{BB} Battery Voltage, transient ISO 7637 Test 2a	+150V
V _{BB} Battery Voltage, transient ISO 7637 Test 3a	-300V
V _{BB} Battery Voltage, transient ISO 7637 Test 3b	+200V
V _{BB} Battery Voltage, continuous	-0.3 to +30V
V _{LBUS} Bus Voltage, continuous.....	-18 to +30V
V _{LBUS} Bus Voltage, transient (Note 1).....	-27 to +43V
I _{LBUS} Bus Short Circuit Current Limit	200 mA
ESD protection on LIN, V _{BB} (IEC 61000-4-2, 330 Ohm, 150 pF) (Note 3).....	minimum ±9 kV
ESD protection on LIN, V _{BB} (Charge Device Model) (Note 2).....	±1500V
ESD protection on LIN, V _{BB} (Human Body Model, 1 kOhm, 100 pF) (Note 4).....	±8 kV
ESD protection on LIN, V _{BB} (Machine Model) (Note 2).....	±800V
ESD protection on all other pins (Human Body Model) (Note 2)	> 4 kV
Maximum Junction Temperature	150°C
Storage Temperature	-55 to +150°C

Note 1: ISO 7637/1 load dump compliant (t < 500 ms).

2: According to JESD22-A114-B.

3: According to IBEE, without bus filter.

4: Limited by Test Equipment.

† **NOTICE:** Stresses above those listed under “Maximum Ratings” may cause permanent damage to the device. This is a stress rating only and functional operation of the device at those or any other conditions above those indicated in the operational listings of this specification is not implied. Exposure to maximum rating conditions for extended periods may affect device reliability.

MCP2021/2/1P/2P

2.2 DC Specifications

DC Specifications	Electrical Characteristics: Unless otherwise indicated, all limits are specified for: V _{BB} = 6.0V to 18.0V T _A = -40°C to +125°C C _{LOADREG} = 10 μF					
	Parameter	Sym	Min.	Typ.	Max.	Units
Power						
V _{BB} Quiescent Operating Current	IBBQ		115	210	μA	I _{OUT} = 0 mA, L _{BUS} recessive
		—	120	215	μA	V _{OUT} = 3.3V
V _{BB} Transmitter-off Current	IBBTO	—	90	190	μA	With V _{REG} on, transmitter off, receiver on, FAULT/TXE = V _{IL} , CS = V _{IH}
		—	95	210	μA	V _{OUT} = 3.3V
V _{BB} Power-Down Current	IBBPD	—	16	26	μA	With V _{REG} powered-off, receiver on and transmitter off, FAULT/TXE = V _{IH} , TXD = V _{IH} , CS = V _{IL})
V _{BB} Current with V _{SS} Floating	IBBNOGND	-1	—	1	mA	V _{BB} = 12V, GND to V _{BB} , V _{LIN} = 0-18V
Microcontroller Interface						
High Level Input Voltage (TXD, FAULT/TXE)	V _{IH}	2.0 or (0.25V _{REG} +0.8)	—	V _{REG} +0.3	V	
Low Level Input Voltage (TXD, FAULT/TXE)	V _{IL}	-0.3	—	0.15 V _{REG}	V	
High Level Input Current (TXD, FAULT/TXE)	I _{IH}	-2.5	—	—	μA	Input voltage = 0.8*V _{REG}
Low Level Input Current (TXD, FAULT/TXE)	I _{IL}	-10	—	—	μA	Input voltage = 0.2*V _{REG}
Pull-up Current on Input (TXD)	I _{PUTXD}	-3.0	—	—	μA	~800 kΩ internal pull-up to V _{REG} @ V _{IH} = 0.7*V _{REG}
High Level Input Voltage (CS/LWAKE)	V _{IH}	0.7V _{REG}	—	V _{BB}	V	Through a current-limiting resistor
Low Level Input Voltage (CS/LWAKE)	V _{IL}	-0.3	—	0.3V _{REG}	V	
High Level Input Current (CS/LWAKE)	I _{IH}	—	—	7.0	μA	Input voltage = 0.8*V _{REG}
Low Level Input Current (CS/LWAKE)	I _{IL}	—	—	3.0	μA	Input voltage = 0.2*V _{REG}
Pull-down Current on Input (CS/LWAKE)	I _{PDCS}	—	—	6.0	μA	~1.3MΩ internal pull-down to V _{SS} @ V _{IH} = 3.5V

Note 1: Internal current limited. 2.0 ms maximum recovery time (R_{LBUS} = 0Ω, TX = 0.4 V_{REG}, V_{LBUS} = V_{BB}).

2: For design guidance only, not tested.

3: Node has to sustain the current that can flow under this condition; bus must be operational under this condition.

2.2 DC Specifications (Continued)

DC Specifications		Electrical Characteristics: Unless otherwise indicated, all limits are specified for: V _{BB} = 6.0V to 18.0V T _A = -40°C to +125°C C _{LOADREG} = 10 μF				
Parameter	Sym	Min.	Typ.	Max.	Units	Conditions
Bus Interface						
High Level Input Voltage	V _{IH} (LBUS)	0.6 V _{BB}	—	18	V	Recessive state
Low Level Input Voltage	V _{IL} (LBUS)	-8	—	0.4 V _{BB}	V	Dominant state
Input Hysteresis	V _{HYS}	—	—	0.175 V _{BB}	V	V _{IH} (LBUS) - V _{IL} (LBUS)
Low Level Output Current	I _{OL} (LBUS)	40	—	200	mA	Output voltage = 0.1 V _{BB} , V _{BB} = 12V
Pull-up Current on Input	I _{PU} (LBUS)	5	—	180	μA	~30 kΩ internal pull-up @ V _{IH} (LBUS) = 0.7 V _{BB}
Short Circuit Current Limit	I _{SC}	50	—	200	mA	(Note 1)
High Level Output Voltage	V _{OH} (LBUS)	0.8 V _{BB}	—	V _{BB}	V	V _{OH} (LBUS) must be at least 0.8 V _{BB}
Low Level Output Voltage	V _{OLLO} (LBUS)	—	—	0.2 V _{BB}	V	
Input Leakage Current (at the receiver during dominant bus level)	I _{BUS_PAS_DOM}	-1	—	—	mA	Driver off, V _{BUS} = 0V, V _{BAT} = 12V
Leakage Current (disconnected from ground)	I _{BUS_NO_GND}	-1	—	+1	mA	G _{NDDEVICE} = V _{BAT} , 0V < V _{BUS} < 18V, V _{BAT} = 12V
Leakage Current (disconnected from V _{BAT})	I _{BUS}	—	—	10	μA	V _{BAT} = G _{ND} , 0 < V _{BUS} < 18V, T _A = -40°C to +85°C (Note 3)
				50	μA	T _A = +85°C to +125°C
Receiver Center Voltage	V _{BUS_CNT}	0.475 V _{BB}	0.5 V _{BB}	0.525 V _{BB}	V	V _{BUS_CNT} = (V _{IL} (LBUS) + V _{IH} (LBUS))/2
Slave Termination	R _{slave}	20	30	47	kΩ	

Note 1: Internal current limited. 2.0 ms maximum recovery time (R_{LBUS} = 0Ω, TX = 0.4 V_{REG}, V_{LBUS} = V_{BB}).

2: For design guidance only, not tested.

3: Node has to sustain the current that can flow under this condition; bus must be operational under this condition.

MCP2021/2/1P/2P

2.2 DC Specification (Continued)

DC Specifications	Electrical Characteristics:					
	Unless otherwise indicated, all limits are specified for: $V_{BB} = 6.0V$ to $18.0V$ $T_A = -40^{\circ}C$ to $+125^{\circ}C$ $C_{LOADREG} = 10 \mu F$					
Parameter	Sym	Min.	Typ.	Max.	Units	Conditions
Voltage Regulator - 5.0V						
Output Voltage	V_{OUT}	4.85	5.00	5.15	V	$0 \text{ mA} < I_{OUT} < 50 \text{ mA}$,
Load Regulation	ΔV_{OUT2}	—	10	50	mV	$5 \text{ mA} < I_{OUT} < 50 \text{ mA}$ refer to Section 1.6 “Internal Voltage Regulator”
Quiescent Current	I_{VRQ}	—	—	25	μA	$I_{OUT} = 0 \text{ mA}$, (Note 2)
Power Supply Ripple Reject	PSRR	—	—	50	dB	$1 V_{PP}$ @ 10-20 kHz $C_{LOAD} = 10 \mu f$, $I_{LOAD} = 50 \text{ mA}$
Output Noise Voltage	eN	—	—	100	μV_{RMS}	10 Hz – 40 MHz $C_{FILTER} = 10 \mu f$, $C_{BP} = 0.1 \mu f$, $C_{LOAD} 10 \mu f$, $I_{LOAD} = 50 \text{ mA}$
Shutdown Voltage	V_{SD}	3.5	—	4.0	V	See Figure 1-8
Input Voltage to Maintain Regulation	V_{BB}	6.0	—	18.0	V	
Input Voltage to Turn Off Output	V_{OFF}	4.0	—	4.5	V	
Input Voltage to Turn On Output	V_{ON}	5.5	—	6.0	V	

- Note 1:** Internal current limited. 2.0 ms maximum recovery time ($R_{L_{BUS}} = 0\Omega$, $T_X = 0.4 V_{REG}$, $V_{L_{BUS}} = V_{BB}$).
- Note 2:** For design guidance only, not tested.
- Note 3:** Node has to sustain the current that can flow under this condition; bus must be operational under this condition.



FIGURE 2-1: MCP2021-500 Safe Operating Range.

2.2 DC Specification (Continued)

Parameter	Sym	Min.	Typ.	Max.	Units	Conditions
Electrical Characteristics: Unless otherwise indicated, all limits are specified for: $V_{BB} = 6.0V$ to $18.0V$ $T_A = -40^{\circ}C$ to $+125^{\circ}C$ $C_{LOADREG} = 10 \mu F$						
Voltage Regulator - 3.3V						
Output Voltage	V_{OUT}	3.20	3.30	3.40	V	$0 \text{ mA} < I_{OUT} < 50 \text{ mA}$
Line Regulation	ΔV_{OUT1}	—	10	50	mV	$I_{OUT} = 1 \text{ mA}$, $6.0V < V_{BB} < 18V$
Load Regulation	ΔV_{OUT2}	—	10	50	mV	$5 \text{ mA} < I_{OUT} < 50 \text{ mA}$ Refer to Section 1.6 "Internal Voltage Regulator"
Quiescent Current	I_{VRQ}	—	—	25	μA	$I_{OUT} = 0 \text{ mA}$, (Note 2)
Power Supply Ripple Reject	PSRR	—	—	50	dB	$1 V_{PP}$ @ 10-20 kHz $C_{LOAD} = 10 \mu f$, $I_{LOAD} = 50 \text{ mA}$
Output Noise Voltage	eN	—	—	100	$\mu V_{RMS} / \sqrt{Hz}$	10 Hz – 40 MHz $C_{FILTER} = 10 \mu f$, $C_{BP} = 0.1 \mu f$ $C_{LOAD} = 10 \mu f$, $I_{LOAD} = 50 \text{ mA}$
Shutdown Voltage	V_{SD}	2.5	—	2.7	V	See Figure 1-8
Input Voltage to Maintain Regulation	V_{BB}	6.0	—	18.0	V	
Input Voltage to Turn Off Output	V_{OFF}	4.0	—	4.5	V	
Input Voltage to Turn On Output	V_{ON}	5.5	—	6.0	V	

- Note 1:** Internal current limited. 2.0 ms maximum recovery time ($R_{LBUS} = 0\Omega$, $T_X = 0.4 V_{REG}$, $V_{LBUS} = V_{BB}$).
- 2:** For design guidance only, not tested.
- 3:** Node has to sustain the current that can flow under this condition; bus must be operational under this condition.



FIGURE 2-2: MCP2021-330 Safe Operating Range.



FIGURE 2-3: ESR Curves for Load Capacitor Selection.

2.3 AC Specification

AC CHARACTERISTICS		V _{BB} = 6.0V to 18.0V; T _A = -40°C to +125°C				
Parameter	Sym	Min.	Typ.	Max.	Units	Test Conditions
Bus Interface - Constant Slope Time Parameters						
Slope rising and falling edges	tSLOPE	3.5	—	22.5	μs	7.3V ≤ V _{BB} ≤ 18V
Propagation Delay of Transmitter	tTRANSPD	—	—	4.0	μs	tTRANSPD = max (tTRANSPDR or tTRANSPDF)
Propagation Delay of Receiver	tRECPD	—	—	6.0	μs	tRECPD = max (tRECPDR or tRECPDF)
Symmetry of Propagation Delay of Receiver rising edge w.r.t. falling edge	tRECSYM	-2.0	—	2.0	μs	tRECSYM = max (tRECPDF - tRECPDR)
Symmetry of Propagation Delay of Transmitter rising edge w.r.t. falling edge	tTRANSSYM	-2.0	—	2.0	μs	tTRANSSYM = max (tTRANSPDF - tTRANSPDR)
Time to sample of FAULT/ TXE for bus conflict reporting	tFAULT	—	—	32.5	μs	tFAULT = max (tTRANSPD + tSLOPE + tRECPD)
Duty Cycle 1 @20.0 kbit/sec		39.6	—	—	%tBIT	CBUS;RBUS conditions: 1 nF; 1 kΩ 6.8 nF; 660Ω 10 nF; 500Ω THREC(MAX) = 0.744 x V _{BB} , THDOM(MAX) = 0.581 x V _{BB} , V _{BB} = 7.0V - 18V; tBIT = 50 μs. D1 = tBUS_REC(MIN) / 2 x tBIT)
Duty Cycle 2 @20.0 kbit/sec		—	—	58.1	%tBIT	CBUS;RBUS conditions: 1 nF; 1 kΩ 6.8 nF; 660Ω 10 nF; 500Ω THREC(MAX) = 0.284 x V _{BB} , THDOM(MAX) = 0.422 x V _{BB} , V _{BB} = 7.6V - 18V; tBIT = 50 μs. D2 = tBUS_REC(MAX) / 2 x tBIT)
Duty Cycle 3 @10.4 kbit/sec		41.7	—	—	%tBIT	CBUS;RBUS conditions: 1 nF; 1 kΩ 6.8 nF; 660Ω 10 nF; 500Ω THREC(MAX) = 0.778 x V _{BB} , THDOM(MAX) = 0.616 x V _{BB} , V _{BB} = 7.0V - 18V; tBIT = 96 μs. D3 = tBUS_REC(MIN) / 2 x tBIT)
Duty Cycle 4 @10.4 kbit/sec		—	—	59.0	%tBIT	CBUS;RBUS conditions: 1 nF; 1 kΩ 6.8 nF; 660Ω 10 nF; 500Ω THREC(MAX) = 0.251 x V _{BB} , THDOM(MAX) = 0.389 x V _{BB} , V _{BB} = 7.6V - 18V; tBIT = 96 μs. D4 = tBUS_REC(MAX) / 2 x tBIT)

MCP2021/2/1P/2P

2.3 AC Specification (Continued)

AC CHARACTERISTICS		$V_{BB} = 6.0V$ to $18.0V$; $T_A = -40^{\circ}C$ to $+125^{\circ}C$				
Parameter	Sym	Min.	Typ.	Max.	Units	Test Conditions
Voltage Regulator						
Bus Activity Debounce Time	tBDB	5	10	20	μs	Bus debounce time
Bus Activity to Voltage Regulator Enabled	tBACTVE	100	250	500	μs	After bus debounce time
Voltage Regulator Enabled to Ready	tVEVR	—	—	1200	μs	(Note 1)
Chip Select to Operation Ready	tCSOR	—	—	500	μs	(Note 1)
Chip Select to Power-Down	tCSPD	—	—	80	μs	
Short-Circuit to Shut-Down	tSHUTDOWN	20	—	100	μs	
RESET Timing						
VREG OK Detect to \overline{RESET} Inactive	tRPU	—	—	10.0	μs	
VREG OK Detect to \overline{RESET} Active	tRPD	—	—	10.0	μs	

Note 1: Time depends on external capacitance and load.

2.4 Thermal Specifications

THERMAL CHARACTERISTICS					
Parameter	Symbol	Typ	Max	Units	Test Conditions
Recovery Temperature	$\theta_{RECOVERY}$	+140	—	$^{\circ}C$	
Shutdown Temperature	$\theta_{SHUTDOWN}$	+150	—	$^{\circ}C$	
Short Circuit Recovery Time	tTHERM	1.5	5.0	ms	
Thermal Package Resistances					
Thermal Resistance, 8L-DFN	θ_{JA}	35.7	—	$^{\circ}C/W$	
Thermal Resistance, 8L-PDIP	θ_{JA}	89.3	—	$^{\circ}C/W$	
Thermal Resistance, 8L-SOIC	θ_{JA}	149.5	—	$^{\circ}C/W$	
Thermal Resistance, 14L-PDIP	θ_{JA}	70	—	$^{\circ}C/W$	
Thermal Resistance, 14L-SOIC	θ_{JA}	95.3	—	$^{\circ}C/W$	
Thermal Resistance, 14L-TSSOP	θ_{JA}	100	—	$^{\circ}C/W$	

Note 1: The maximum power dissipation is a function of T_{JMAX} , θ_{JA} and ambient temperature T_A . The maximum allowable power dissipation at an ambient temperature is $P_D = (T_{JMAX} - T_A) \theta_{JA}$. If this dissipation is exceeded, the die temperature will rise above $150^{\circ}C$ and the MCP2021 will go into thermal shutdown.

2.5 Timing Diagrams and Specifications



FIGURE 2-4: Bus Timing Diagram.



FIGURE 2-5: Regulator CS/LWAKE Timing Diagram.

MCP2021/2/1P/2P



FIGURE 2-6: Regulator BUS WAKE Timing Diagram.



FIGURE 2-7: RESET Timing Diagram.



FIGURE 2-8: CS/LWAKE to $\overline{\text{RESET}}$ Timing Diagram.



FIGURE 2-9: Typical I_{BBQ} vs. Temperature.

MCP2021/2/1P/2P



FIGURE 2-10: Typical I_{BBTO} vs Temperature.



FIGURE 2-11: Typical I_{BBPD} vs. Temperature.

3.0 PACKAGING INFORMATION

3.1 Package Marking Information

8-Lead DFN (4x4x0.9 mm)



MCP2021	MCP2021P
2021500	2021P50

Example

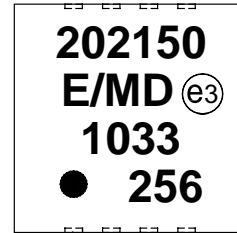

8-Lead DFN-S (6x5x0.9 mm)

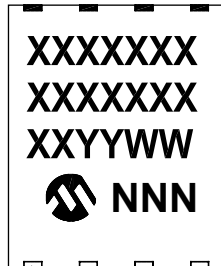

MCP2021
202150

Example

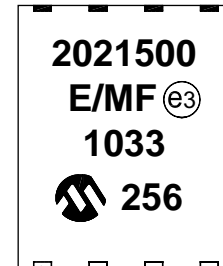

8-Lead PDIP (300 mil)



MCP2021	MCP2021P
2021500	2021P500

Example

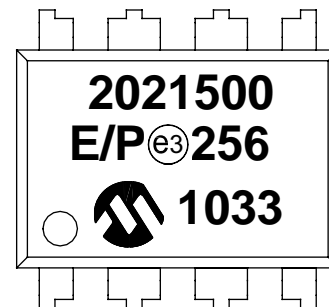

Legend:	XX...X	Customer-specific information
	Y	Year code (last digit of calendar year)
	YY	Year code (last 2 digits of calendar year)
	WW	Week code (week of January 1 is week '01')
	NNN	Alphanumeric traceability code
	(e3)	Pb-free JEDEC designator for Matte Tin (Sn)
	*	This package is Pb-free. The Pb-free JEDEC designator (e3) can be found on the outer packaging for this package.

Note: In the event the full Microchip part number cannot be marked on one line, it will be carried over to the next line, thus limiting the number of available characters for customer-specific information.

MCP2021/2/1P/2P

3.1 Package Marking Information (Continued)

8-Lead SOIC (3.90 mm)



MCP2021	MCP2021P
2021500E	2021P50E

Example



14-Lead PDIP (300 mil)



MCP2022	MCP2022P
MCP2022-500	MCP2022P-500

Example



14-Lead SOIC (3.90 mm)

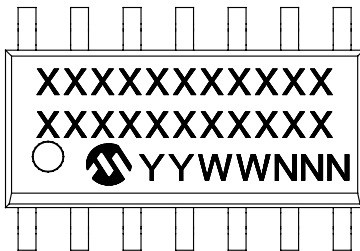

MCP2022	MCP2022P
MCP2022-500	2022P-500

Example

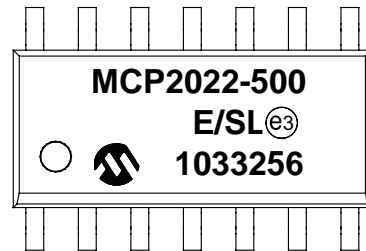

Legend:	XX...X	Customer-specific information
	Y	Year code (last digit of calendar year)
	YY	Year code (last 2 digits of calendar year)
	WW	Week code (week of January 1 is week '01')
	NNN	Alphanumeric traceability code
	(e3)	Pb-free JEDEC designator for Matte Tin (Sn)
	*	This package is Pb-free. The Pb-free JEDEC designator (e3) can be found on the outer packaging for this package.
Note:	In the event the full Microchip part number cannot be marked on one line, it will be carried over to the next line, thus limiting the number of available characters for customer-specific information.	

3.1 Package Marking Information (Continued)

14-Lead TSSOP (4.4 mm)

Example



MCP2022	MCP2022P
2022500E	2022P50E



Legend:	XX...X	Customer-specific information
	Y	Year code (last digit of calendar year)
	YY	Year code (last 2 digits of calendar year)
	WW	Week code (week of January 1 is week '01')
	NNN	Alphanumeric traceability code
	(e3)	Pb-free JEDEC designator for Matte Tin (Sn)
	*	This package is Pb-free. The Pb-free JEDEC designator (e3) can be found on the outer packaging for this package.

Note: In the event the full Microchip part number cannot be marked on one line, it will be carried over to the next line, thus limiting the number of available characters for customer-specific information.

MCP2021/2/1P/2P

8-Lead Plastic Dual Flat, No Lead Package (MD) – 4x4x0.9 mm Body [DFN]

Note: For the most current package drawings, please see the Microchip Packaging Specification located at <http://www.microchip.com/packaging>



Dimension Limits	Units	MILLIMETERS		
		MIN	NOM	MAX
Number of Pins	N	8		
Pitch	e	0.80 BSC		
Overall Height	A	0.80	0.90	1.00
Standoff	A1	0.00	0.02	0.05
Contact Thickness	A3	0.20 REF		
Overall Length	D	4.00 BSC		
Exposed Pad Width	E2	0.00	2.20	2.80
Overall Width	E	4.00 BSC		
Exposed Pad Length	D2	0.00	3.00	3.60
Contact Width	b	0.25	0.30	0.35
Contact Length	L	0.30	0.55	0.65
Contact-to-Exposed Pad	K	0.20	–	–

Notes:

1. Pin 1 visual index feature may vary, but must be located within the hatched area.
2. Package may have one or more exposed tie bars at ends.
3. Package is saw singulated.
4. Dimensioning and tolerancing per ASME Y14.5M.
 - BSC: Basic Dimension. Theoretically exact value shown without tolerances.
 - REF: Reference Dimension, usually without tolerance, for information purposes only.

Microchip Technology Drawing C04-131C

8-Lead Plastic Dual Flat, No Lead Package (MD) – 4x4x0.9 mm Body [DFN]

Note: For the most current package drawings, please see the Microchip Packaging Specification located at <http://www.microchip.com/packaging>



RECOMMENDED LAND PATTERN

Dimension Limits	Units	MILLIMETERS		
		MIN	NOM	MAX
Contact Pitch	E	0.80 BSC		
Optional Center Pad Width	W2			3.60
Optional Center Pad Length	T2			2.50
Contact Pad Spacing	C1		4.00	
Contact Pad Width (X8)	X1			0.35
Contact Pad Length (X8)	Y1			0.75
Distance Between Pads	G	0.45		

Notes:

1. Dimensioning and tolerancing per ASME Y14.5M

BSC: Basic Dimension. Theoretically exact value shown without tolerances.

Microchip Technology Drawing No. C04-2131B

MCP2021/2/1P/2P

8-Lead Plastic Dual Flat, No Lead Package (MF) – 6x5 mm Body [DFN-S]

Note: For the most current package drawings, please see the Microchip Packaging Specification located at <http://www.microchip.com/packaging>



Dimension Limits	Units	MILLIMETERS		
		MIN	NOM	MAX
Number of Pins	N	8		
Pitch	e	1.27 BSC		
Overall Height	A	0.80	0.85	1.00
Standoff	A1	0.00	0.01	0.05
Contact Thickness	A3	0.20 REF		
Overall Length	D	5.00 BSC		
Overall Width	E	6.00 BSC		
Exposed Pad Length	D2	3.90	4.00	4.10
Exposed Pad Width	E2	2.20	2.30	2.40
Contact Width	b	0.35	0.40	0.48
Contact Length	L	0.50	0.60	0.75
Contact-to-Exposed Pad	K	0.20	-	-

Notes:

1. Pin 1 visual index feature may vary, but must be located within the hatched area.
2. Package may have one or more exposed tie bars at ends.
3. Package is saw singulated.
4. Dimensioning and tolerancing per ASME Y14.5M.

BSC: Basic Dimension. Theoretically exact value shown without tolerances.

REF: Reference Dimension, usually without tolerance, for information purposes only.

Microchip Technology Drawing C04-122B

8-Lead Plastic Dual Flat, No Lead Package (MF) - 6x5 mm Body [DFN-S]

Note: For the most current package drawings, please see the Microchip Packaging Specification located at <http://www.microchip.com/packaging>



RECOMMENDED LAND PATTERN

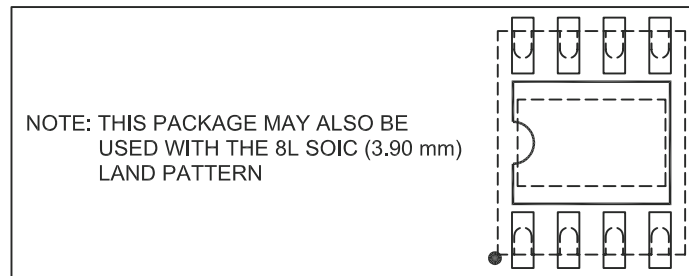

Dimension Limits	Units	MILLIMETERS		
		MIN	NOM	MAX
Contact Pitch	E	1.27 BSC		
Optional Center Pad Width	W2			2.40
Optional Center Pad Length	T2			4.10
Contact Pad Spacing	C		5.60	
Contact Pad Width (X8)	X1			0.45
Contact Pad Length (X8)	Y1			1.10

Notes:

1. Dimensioning and tolerancing per ASME Y14.5M

BSC: Basic Dimension. Theoretically exact value shown without tolerances.

Microchip Technology Drawing No. C04-2122A

MCP2021/2/1P/2P

8-Lead Plastic Dual In-Line (P) – 300 mil Body [PDIP]

Note: For the most current package drawings, please see the Microchip Packaging Specification located at <http://www.microchip.com/packaging>



		Units	INCHES		
Dimension Limits			MIN	NOM	MAX
Number of Pins	N		8		
Pitch	e		.100 BSC		
Top to Seating Plane	A	–	–		.210
Molded Package Thickness	A2	.115	.130		.195
Base to Seating Plane	A1	.015	–		–
Shoulder to Shoulder Width	E	.290	.310		.325
Molded Package Width	E1	.240	.250		.280
Overall Length	D	.348	.365		.400
Tip to Seating Plane	L	.115	.130		.150
Lead Thickness	c	.008	.010		.015
Upper Lead Width	b1	.040	.060		.070
Lower Lead Width	b	.014	.018		.022
Overall Row Spacing §	eB	–	–		.430

Notes:

- Pin 1 visual index feature may vary, but must be located with the hatched area.
- § Significant Characteristic.
- Dimensions D and E1 do not include mold flash or protrusions. Mold flash or protrusions shall not exceed .010" per side.
- Dimensioning and tolerancing per ASME Y14.5M.

BSC: Basic Dimension. Theoretically exact value shown without tolerances.

Microchip Technology Drawing C04-018B

8-Lead Plastic Small Outline (SN) – Narrow, 3.90 mm Body [SOIC]

Note: For the most current package drawings, please see the Microchip Packaging Specification located at <http://www.microchip.com/packaging>



Dimension Limits	Units	MILLIMETERS		
		MIN	NOM	MAX
Number of Pins	N	8		
Pitch	e	1.27 BSC		
Overall Height	A	–	–	1.75
Molded Package Thickness	A2	1.25	–	–
Standoff §	A1	0.10	–	0.25
Overall Width	E	6.00 BSC		
Molded Package Width	E1	3.90 BSC		
Overall Length	D	4.90 BSC		
Chamfer (optional)	h	0.25	–	0.50
Foot Length	L	0.40	–	1.27
Footprint	L1	1.04 REF		
Foot Angle	ϕ	0°	–	8°
Lead Thickness	c	0.17	–	0.25
Lead Width	b	0.31	–	0.51
Mold Draft Angle Top	α	5°	–	15°
Mold Draft Angle Bottom	β	5°	–	15°

Notes:

- Pin 1 visual index feature may vary, but must be located within the hatched area.
- § Significant Characteristic.
- Dimensions D and E1 do not include mold flash or protrusions. Mold flash or protrusions shall not exceed 0.15 mm per side.
- Dimensioning and tolerancing per ASME Y14.5M.

BSC: Basic Dimension. Theoretically exact value shown without tolerances.

REF: Reference Dimension, usually without tolerance, for information purposes only.

Microchip Technology Drawing C04-057B

MCP2021/2/1P/2P

8-Lead Plastic Small Outline (SN) – Narrow, 3.90 mm Body [SOIC]

Note: For the most current package drawings, please see the Microchip Packaging Specification located at <http://www.microchip.com/packaging>



RECOMMENDED LAND PATTERN

Dimension Limits	Units	MILLIMETERS		
		MIN	NOM	MAX
Contact Pitch	E	1.27 BSC		
Contact Pad Spacing	C		5.40	
Contact Pad Width (X8)	X1			0.60
Contact Pad Length (X8)	Y1			1.55

Notes:

1. Dimensioning and tolerancing per ASME Y14.5M

BSC: Basic Dimension. Theoretically exact value shown without tolerances.

Microchip Technology Drawing No. C04-2057A

14-Lead Plastic Dual In-Line (P) – 300 mil Body [PDIP]

Note: For the most current package drawings, please see the Microchip Packaging Specification located at <http://www.microchip.com/packaging>



Dimension Limits	Units	INCHES		
		MIN	NOM	MAX
Number of Pins	N	14		
Pitch	e	.100 BSC		
Top to Seating Plane	A	–	–	.210
Molded Package Thickness	A2	.115	.130	.195
Base to Seating Plane	A1	.015	–	–
Shoulder to Shoulder Width	E	.290	.310	.325
Molded Package Width	E1	.240	.250	.280
Overall Length	D	.735	.750	.775
Tip to Seating Plane	L	.115	.130	.150
Lead Thickness	c	.008	.010	.015
Upper Lead Width	b1	.045	.060	.070
Lower Lead Width	b	.014	.018	.022
Overall Row Spacing §	eB	–	–	.430

Notes:

- Pin 1 visual index feature may vary, but must be located with the hatched area.
- § Significant Characteristic.
- Dimensions D and E1 do not include mold flash or protrusions. Mold flash or protrusions shall not exceed .010" per side.
- Dimensioning and tolerancing per ASME Y14.5M.

BSC: Basic Dimension. Theoretically exact value shown without tolerances.

Microchip Technology Drawing C04-005B

MCP2021/2/1P/2P

14-Lead Plastic Small Outline (SL) – Narrow, 3.90 mm Body [SOIC]

Note: For the most current package drawings, please see the Microchip Packaging Specification located at <http://www.microchip.com/packaging>



Dimension Limits	Units	MILLIMETERS		
		MIN	NOM	MAX
Number of Pins	N	14		
Pitch	e	1.27 BSC		
Overall Height	A	–	–	1.75
Molded Package Thickness	A2	1.25	–	–
Standoff §	A1	0.10	–	0.25
Overall Width	E	6.00 BSC		
Molded Package Width	E1	3.90 BSC		
Overall Length	D	8.65 BSC		
Chamfer (optional)	h	0.25	–	0.50
Foot Length	L	0.40	–	1.27
Footprint	L1	1.04 REF		
Foot Angle	ϕ	0°	–	8°
Lead Thickness	c	0.17	–	0.25
Lead Width	b	0.31	–	0.51
Mold Draft Angle Top	α	5°	–	15°
Mold Draft Angle Bottom	β	5°	–	15°

Notes:

- Pin 1 visual index feature may vary, but must be located within the hatched area.
- § Significant Characteristic.
- Dimensions D and E1 do not include mold flash or protrusions. Mold flash or protrusions shall not exceed 0.15 mm per side.
- Dimensioning and tolerancing per ASME Y14.5M.

BSC: Basic Dimension. Theoretically exact value shown without tolerances.

REF: Reference Dimension, usually without tolerance, for information purposes only.

Microchip Technology Drawing C04-065B

14-Lead Plastic Small Outline (SL) - Narrow, 3.90 mm Body [SOIC]

Note: For the most current package drawings, please see the Microchip Packaging Specification located at <http://www.microchip.com/packaging>

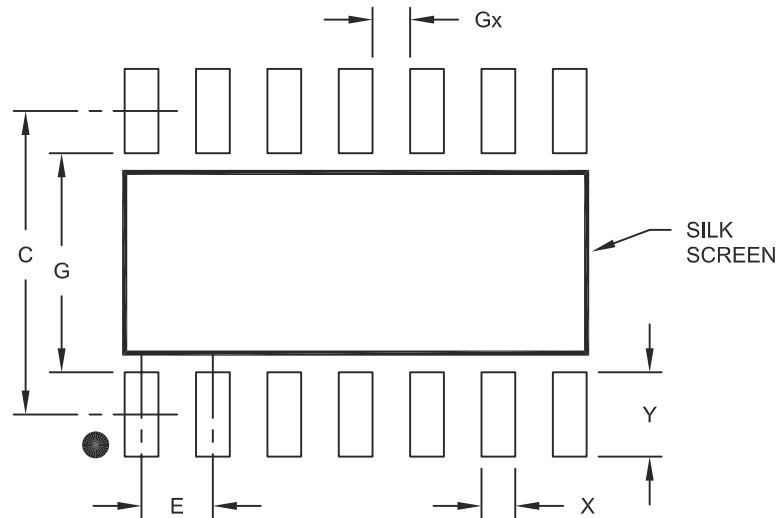

RECOMMENDED LAND PATTERN

Dimension Limits	Units	MILLIMETERS		
		MIN	NOM	MAX
Contact Pitch	E	1.27 BSC		
Contact Pad Spacing	C		5.40	
Contact Pad Width	X			0.60
Contact Pad Length	Y			1.50
Distance Between Pads	Gx	0.67		
Distance Between Pads	G	3.90		

Notes:

1. Dimensioning and tolerancing per ASME Y14.5M

BSC: Basic Dimension. Theoretically exact value shown without tolerances.

Microchip Technology Drawing No. C04-2065A

MCP2021/2/1P/2P

14-Lead Plastic Thin Shrink Small Outline (ST) – 4.4 mm Body [TSSOP]

Note: For the most current package drawings, please see the Microchip Packaging Specification located at <http://www.microchip.com/packaging>



Dimension Limits	Units	MILLIMETERS		
		MIN	NOM	MAX
Number of Pins	N	14		
Pitch	e	0.65 BSC		
Overall Height	A	–	–	1.20
Molded Package Thickness	A2	0.80	1.00	1.05
Standoff	A1	0.05	–	0.15
Overall Width	E	6.40 BSC		
Molded Package Width	E1	4.30	4.40	4.50
Molded Package Length	D	4.90	5.00	5.10
Foot Length	L	0.45	0.60	0.75
Footprint	L1	1.00 REF		
Foot Angle	ϕ	0°	–	8°
Lead Thickness	c	0.09	–	0.20
Lead Width	b	0.19	–	0.30

Notes:

- Pin 1 visual index feature may vary, but must be located within the hatched area.
- Dimensions D and E1 do not include mold flash or protrusions. Mold flash or protrusions shall not exceed 0.15 mm per side.
- Dimensioning and tolerancing per ASME Y14.5M.

BSC: Basic Dimension. Theoretically exact value shown without tolerances.

REF: Reference Dimension, usually without tolerance, for information purposes only.

Microchip Technology Drawing C04-087B

APPENDIX A: REVISION HISTORY

Revision F (January 2012)

The following modifications were made to this data sheet:

Added the MCP2021P and MCP2022P options and related information throughout the document.

Revision E (February 2009)

The following is the list of modifications.

1. Added Example 1-7 and Example 1-8.
2. Updated [Section 1.4.9 “RESET”](#).
3. Updated [Section 1.7 “ICSP™ Considerations”](#).
4. Updated [Section 2.1 “Absolute Maximum Ratings†”](#).
5. Updated [Section 2.2 “DC Specifications”](#) and [Section 2.3 “AC Specification”](#).
6. Added [FIGURE 2-3: “ESR Curves for Load Capacitor Selection.”](#)
7. Updated the Product Identification System section.

Revision D (July 2008)

The following is the list of modifications.

1. Updated ESD specs under ‘Absolute DC’.
2. Updated notes in Example 1-1.
3. Updated Package Outline Drawings.

Revision C (April 2008)

The following is the list of modifications.

1. Added LIN2.1 and J2602 compliance statement to Features section.
2. Added recommended RC network for CS/LWAKE in Example 1-1.
3. Updated 2.1 Absolute Maximum Ratings to reflect current test results.
4. Updated 2.2 DC Specifications and 2.3 AC Specifications to reflect current production device.
5. Added 8-Lead SOIC Landing Pattern Outline drawing.

Revision B (August 2007)

The following is the list of modifications:

1. Modified Block Diagram on page 2.
2. [Section 1.3.5 “Transmitter-OFF Mode”](#): Deleted text in 1st paragraph.
3. [Example 1-6](#): Removed +5V notation.
4. [Section 1.4 “Pin Descriptions”](#): Removed 10-pin DFN, MSOP column from table.
5. [Section 1.4.8 “Fault/TXE”](#): Deleted text from 2nd paragraph.
6. [Section 3.0 “Packaging Information”](#): Added 8-lead 4x4 and 6x5 DFN and 14-lead TSSOP packages. Updated package outline drawings and added drawings for 8-lead DFN and 14-lead TSSOP drawings.

Revision A (November 2005)

Original Release of this Document.

MCP2021/2/1P/2P

NOTES:

PRODUCT IDENTIFICATION SYSTEM

To order or obtain information, e.g., on pricing or delivery, refer to the factory or the listed sales office.

<u>PART NO.</u>	<u>-X</u>	<u>/XX</u>	Examples:
Device	Temperature Range	Package	
Device:	MCP2021:	LIN Transceiver with Voltage Regulator; wakes up on dominant level of LIN bus.	a) MCP2021-330E/SN: 3.3V, 8L-SOIC pkg.
	MCP2021T:	LIN Transceiver with Voltage Regulator; wakes up on dominant level of LIN bus. (Tape and Reel) (SOIC only)	b) MCP2021-330E/P: 3.3V, 8L-PDIP pkg.
	MCP2022:	LIN Transceiver with Voltage Regulator, and RESET pin; wakes up on dominant level of LIN bus.	c) MCP2021-500E/MF: 5.0V, 8L-DFN-S pkg.
	MCP2022T:	LIN Transceiver with Voltage Regulator, and RESET pin; wakes up on dominant level of LIN bus. (Tape and Reel) (SOIC only)	d) MCP2021-500E/SN: 5.0V, 8L-SOIC pkg.
	MCP2021P:	LIN Transceiver with Voltage Regulator; wakes up at a falling edge of LIN bus level.	e) MCP2021-500E/MD: 5.0V, 8L-DFN pkg.
	MCP2021PT:	LIN Transceiver with Voltage Regulator; wakes up at a falling edge of LIN bus level (Tape and Reel) (SOIC only)	f) MCP2021-330E/P: 5.0V, 8L-PDIP pkg.
	MCP2022P:	LIN Transceiver with Voltage Regulator, and RESET pin; wakes up at a falling edge of LIN bus level.	g) MCP2021T-330E/SN: Tape and Reel, 3.3V, 8L-SOIC pkg.
	MCP2022PT:	LIN Transceiver with Voltage Regulator, and RESET pin; wakes up at a falling edge of LIN bus level. (Tape and Reel) (SOIC only)	h) MCP2021T-500E/MD: Tape and Reel, 5.0V, 8L-DFN pkg.
Temperature Range:	E	= -40°C to +125°C	i) MCP2021T-500E/SN: Tape and Reel, 5.0V, 8L-SOIC pkg.
Package:	MD	= Plastic Micro Small Outline (4x4), 8-lead	a) MCP2022-330E/SL: 3.3V, 14L-SOIC pkg.
	MF	= Plastic Micro Small Outline (6x5), 8-lead	b) MCP2022-330E/P: 3.3V, 14L-PDIP pkg.
	P	= Plastic DIP (300 mil Body), 8-lead, 14-lead	c) MCP2022-500E/SL: 5.0V, 14L-SOIC pkg.
	SN	= Plastic SOIC, (150 mil Body), 8-lead	d) MCP2022-500E/P: 5.0V, 14L-PDIP pkg.
	SL	= Plastic SOIC, (150 mil Body), 14-lead	e) MCP2022T-330E/SL: Tape and Reel, 3.3V, 14L-SOIC pkg.
	ST	= Plastic Thin Shrink Small Outline, 14-lead	f) MCP2022T-500E/SL: Tape and Reel, 5.0V, 14L-SOIC pkg.
			g) MCP2022T-500E/ST: Tape and Reel, 5.0V, 14L-TSSOP pkg.

MCP2021/2/1P/2P

NOTES:

Note the following details of the code protection feature on Microchip devices:

- Microchip products meet the specification contained in their particular Microchip Data Sheet.
- Microchip believes that its family of products is one of the most secure families of its kind on the market today, when used in the intended manner and under normal conditions.
- There are dishonest and possibly illegal methods used to breach the code protection feature. All of these methods, to our knowledge, require using the Microchip products in a manner outside the operating specifications contained in Microchip's Data Sheets. Most likely, the person doing so is engaged in theft of intellectual property.
- Microchip is willing to work with the customer who is concerned about the integrity of their code.
- Neither Microchip nor any other semiconductor manufacturer can guarantee the security of their code. Code protection does not mean that we are guaranteeing the product as “unbreakable.”

Code protection is constantly evolving. We at Microchip are committed to continuously improving the code protection features of our products. Attempts to break Microchip's code protection feature may be a violation of the Digital Millennium Copyright Act. If such acts allow unauthorized access to your software or other copyrighted work, you may have a right to sue for relief under that Act.

Information contained in this publication regarding device applications and the like is provided only for your convenience and may be superseded by updates. It is your responsibility to ensure that your application meets with your specifications. MICROCHIP MAKES NO REPRESENTATIONS OR WARRANTIES OF ANY KIND WHETHER EXPRESS OR IMPLIED, WRITTEN OR ORAL, STATUTORY OR OTHERWISE, RELATED TO THE INFORMATION, INCLUDING BUT NOT LIMITED TO ITS CONDITION, QUALITY, PERFORMANCE, MERCHANTABILITY OR FITNESS FOR PURPOSE. Microchip disclaims all liability arising from this information and its use. Use of Microchip devices in life support and/or safety applications is entirely at the buyer's risk, and the buyer agrees to defend, indemnify and hold harmless Microchip from any and all damages, claims, suits, or expenses resulting from such use. No licenses are conveyed, implicitly or otherwise, under any Microchip intellectual property rights.

Trademarks

The Microchip name and logo, the Microchip logo, dsPIC, KEELOQ, KEELOQ logo, MPLAB, PIC, PICmicro, PICSTART, PIC³² logo, rfPIC and UNI/O are registered trademarks of Microchip Technology Incorporated in the U.S.A. and other countries.

FilterLab, Hampshire, HI-TECH C, Linear Active Thermistor, MXDEV, MXLAB, SEEVAL and The Embedded Control Solutions Company are registered trademarks of Microchip Technology Incorporated in the U.S.A.

Analog-for-the-Digital Age, Application Maestro, chipKIT, chipKIT logo, CodeGuard, dsPICDEM, dsPICDEM.net, dsPICworks, dsSPEAK, ECAN, ECONOMONITOR, FanSense, HI-TIDE, In-Circuit Serial Programming, ICSP, Mindi, MiWi, MPASM, MPLAB Certified logo, MPLIB, MPLINK, mTouch, Omniscient Code Generation, PICC, PICC-18, PICDEM, PICDEM.net, PICKit, PICtail, REAL ICE, rfLAB, Select Mode, Total Endurance, TSHARC, UniWinDriver, WiperLock and ZENA are trademarks of Microchip Technology Incorporated in the U.S.A. and other countries.

SQTP is a service mark of Microchip Technology Incorporated in the U.S.A.

All other trademarks mentioned herein are property of their respective companies.

© 2005-2012, Microchip Technology Incorporated, Printed in the U.S.A., All Rights Reserved.

 Printed on recycled paper.

ISBN: 978-1-61341-884-0

Microchip received ISO/TS-16949:2009 certification for its worldwide headquarters, design and wafer fabrication facilities in Chandler and Tempe, Arizona; Gresham, Oregon and design centers in California and India. The Company's quality system processes and procedures are for its PIC[®] MCUs and dsPIC[®] DSCs, KEELOQ[®] code hopping devices, Serial EEPROMs, microperipherals, nonvolatile memory and analog products. In addition, Microchip's quality system for the design and manufacture of development systems is ISO 9001:2000 certified.

QUALITY MANAGEMENT SYSTEM
CERTIFIED BY DNV
== ISO/TS 16949:2009 ==



MICROCHIP

Worldwide Sales and Service

AMERICAS

Corporate Office
2355 West Chandler Blvd.
Chandler, AZ 85224-6199
Tel: 480-792-7200
Fax: 480-792-7277
Technical Support:
<http://www.microchip.com/support>
Web Address:
www.microchip.com

Atlanta
Duluth, GA
Tel: 678-957-9614
Fax: 678-957-1455

Boston
Westborough, MA
Tel: 774-760-0087
Fax: 774-760-0088

Chicago
Itasca, IL
Tel: 630-285-0071
Fax: 630-285-0075

Cleveland
Independence, OH
Tel: 216-447-0464
Fax: 216-447-0643

Dallas
Addison, TX
Tel: 972-818-7423
Fax: 972-818-2924

Detroit
Farmington Hills, MI
Tel: 248-538-2250
Fax: 248-538-2260

Indianapolis
Noblesville, IN
Tel: 317-773-8323
Fax: 317-773-5453

Los Angeles
Mission Viejo, CA
Tel: 949-462-9523
Fax: 949-462-9608

Santa Clara
Santa Clara, CA
Tel: 408-961-6444
Fax: 408-961-6445

Toronto
Mississauga, Ontario,
Canada
Tel: 905-673-0699
Fax: 905-673-6509

ASIA/PACIFIC

Asia Pacific Office
Suites 3707-14, 37th Floor
Tower 6, The Gateway
Harbour City, Kowloon
Hong Kong
Tel: 852-2401-1200
Fax: 852-2401-3431

Australia - Sydney
Tel: 61-2-9868-6733
Fax: 61-2-9868-6755

China - Beijing
Tel: 86-10-8569-7000
Fax: 86-10-8528-2104

China - Chengdu
Tel: 86-28-8665-5511
Fax: 86-28-8665-7889

China - Chongqing
Tel: 86-23-8980-9588
Fax: 86-23-8980-9500

China - Hangzhou
Tel: 86-571-2819-3187
Fax: 86-571-2819-3189

China - Hong Kong SAR
Tel: 852-2401-1200
Fax: 852-2401-3431

China - Nanjing
Tel: 86-25-8473-2460
Fax: 86-25-8473-2470

China - Qingdao
Tel: 86-532-8502-7355
Fax: 86-532-8502-7205

China - Shanghai
Tel: 86-21-5407-5533
Fax: 86-21-5407-5066

China - Shenyang
Tel: 86-24-2334-2829
Fax: 86-24-2334-2393

China - Shenzhen
Tel: 86-755-8203-2660
Fax: 86-755-8203-1760

China - Wuhan
Tel: 86-27-5980-5300
Fax: 86-27-5980-5118

China - Xian
Tel: 86-29-8833-7252
Fax: 86-29-8833-7256

China - Xiamen
Tel: 86-592-2388138
Fax: 86-592-2388130

China - Zhuhai
Tel: 86-756-3210040
Fax: 86-756-3210049

ASIA/PACIFIC

India - Bangalore
Tel: 91-80-3090-4444
Fax: 91-80-3090-4123

India - New Delhi
Tel: 91-11-4160-8631
Fax: 91-11-4160-8632

India - Pune
Tel: 91-20-2566-1512
Fax: 91-20-2566-1513

Japan - Osaka
Tel: 81-66-152-7160
Fax: 81-66-152-9310

Japan - Yokohama
Tel: 81-45-471-6166
Fax: 81-45-471-6122

Korea - Daegu
Tel: 82-53-744-4301
Fax: 82-53-744-4302

Korea - Seoul
Tel: 82-2-554-7200
Fax: 82-2-558-5932 or
82-2-558-5934

Malaysia - Kuala Lumpur
Tel: 60-3-6201-9857
Fax: 60-3-6201-9859

Malaysia - Penang
Tel: 60-4-227-8870
Fax: 60-4-227-4068

Philippines - Manila
Tel: 63-2-634-9065
Fax: 63-2-634-9069

Singapore
Tel: 65-6334-8870
Fax: 65-6334-8850

Taiwan - Hsin Chu
Tel: 886-3-5778-366
Fax: 886-3-5770-955

Taiwan - Kaohsiung
Tel: 886-7-536-4818
Fax: 886-7-330-9305

Taiwan - Taipei
Tel: 886-2-2500-6610
Fax: 886-2-2508-0102

Thailand - Bangkok
Tel: 66-2-694-1351
Fax: 66-2-694-1350

EUROPE

Austria - Wels
Tel: 43-7242-2244-39
Fax: 43-7242-2244-393

Denmark - Copenhagen
Tel: 45-4450-2828
Fax: 45-4485-2829

France - Paris
Tel: 33-1-69-53-63-20
Fax: 33-1-69-30-90-79

Germany - Munich
Tel: 49-89-627-144-0
Fax: 49-89-627-144-44

Italy - Milan
Tel: 39-0331-742611
Fax: 39-0331-466781

Netherlands - Drunen
Tel: 31-416-690399
Fax: 31-416-690340

Spain - Madrid
Tel: 34-91-708-08-90
Fax: 34-91-708-08-91

UK - Wokingham
Tel: 44-118-921-5869
Fax: 44-118-921-5820

11/29/11

Данный компонент на территории Российской Федерации

Вы можете приобрести в компании MosChip.

Для оперативного оформления запроса Вам необходимо перейти по данной ссылке:

<http://moschip.ru/get-element>

Вы можете разместить у нас заказ для любого Вашего проекта, будь то серийное производство или разработка единичного прибора.

В нашем ассортименте представлены ведущие мировые производители активных и пассивных электронных компонентов.

Нашей специализацией является поставка электронной компонентной базы двойного назначения, продукции таких производителей как XILINX, Intel (ex.ALTERA), Vicor, Microchip, Texas Instruments, Analog Devices, Mini-Circuits, Amphenol, Glenair.

Сотрудничество с глобальными дистрибьюторами электронных компонентов, предоставляет возможность заказывать и получать с международных складов практически любой перечень компонентов в оптимальные для Вас сроки.

На всех этапах разработки и производства наши партнеры могут получить квалифицированную поддержку опытных инженеров.

Система менеджмента качества компании отвечает требованиям в соответствии с ГОСТ Р ИСО 9001, ГОСТ РВ 0015-002 и ЭС РД 009

Офис по работе с юридическими лицами:

105318, г.Москва, ул.Щербаковская д.3, офис 1107, 1118, ДЦ «Щербаковский»

Телефон: +7 495 668-12-70 (многоканальный)

Факс: +7 495 668-12-70 (доб.304)

E-mail: info@moschip.ru

Skype отдела продаж:

moschip.ru

moschip.ru_4

moschip.ru_6

moschip.ru_9