



Part Number*	Relay Description
RA00HQ	25 A AC Solid-State Relay
RA58HQ	25 A AC Solid-State Relay with Thermal Protection and Thermal TRIP Status

\* The Y suffix denotes parameters tested to MIL-PRF-28750 specifications. The W suffix denotes parameters tested to Teledyne specifications.

## ELECTRICAL SPECIFICATIONS

(-55°C TO +110°C UNLESS OTHERWISE SPECIFIED)

### INPUT (CONTROL) CHARACTERISTICS

2 Terminal Configuration (See Figure 1)	Min	Max	Units
Input Voltage (See Note 2)	3.8	32	Vdc
Input Current			
$V_{\text{INPUT}} = 5 \text{ Vdc}$		15	mA
$V_{\text{INPUT}} = 32 \text{ Vdc}$		16	mA
Turn-On Input Voltage	4.0		Vdc
Turn-Off Input Voltage		1.5	Vdc
Reverse Polarity		-32	Vdc

### INPUT (CONTROL) SPECIFICATION

3 Terminal Configuration (See Figure 1)	Min	Max	Units
Bias Voltage (See Note 2)	4.0	32	Vdc
Bias Current ( $V_{\text{INPUT}} = 32 \text{ Vdc}$ )		16	mA
Control Voltage Range	0	18	Vdc
Control Current at 5 Vdc		250	$\mu\text{A}$ dc
Turn-On Control Voltage		0.3	Vdc
Turn-Off Control Voltage	3.2		Vdc

### OUTPUT (LOAD) SPECIFICATIONS

	Min	Max	Units
Load Voltage	20	250	Vrms
Frequency Range	40	440	Hz
Continuous Load Current (See Figure 3)			
Without heat sink	0.2	5	Arms
With heat sink	0.2	25	Arms
Output Voltage Drop		1.5	Vrms

## FEATURES/BENEFITS

- Available with thermal protection and thermal TRIP status: Provides self-protection from thermal runaway conditions and indicates protection state for system BIT.
- Optical Isolation: Isolates control elements from load transients with reduced EMI.
- Fully Floating Output: Eliminates ground potential loops and allows the output to sink or source current.
- Buffered Control: Relay can be controlled directly from TTL or CMOS logic circuits.
- Integral Snubber Circuit: Enhances dv/dt capability while minimizing EMI.

## DESCRIPTION

The Series RA solid-state relays (SSRs) are designed for use in AC power switching applications where safety and reliability are primary concerns. These SSRs are rated for load voltages up to 250 Vrms from 40 to 440 Hz and are ideal for resistive and reactive loads with power factors as low as 0.2. Inverse parallel SCRs are configured for zero voltage turn on and can handle current surges up to 100 A. Optical isolation to 1500 Vrms between the control (input) and load (output) allows the load to be safely controlled by logic circuitry. RA relays are available with thermal protection and thermal TRIP status. In case of a thermal runaway condition, the SSR will shut down the output switch and latch off until the input is reset and the junction temperature returns to a safe level. When the output does latch off, the TRIP status line will yield a logic level output indicating the protection state of the SSR. This feature provides the user with failure mode indication while enhancing the system diagnostic capability. These SSRs are packaged in low-profile hermetically sealed cases.

**OUTPUT (LOAD) SPECIFICATIONS**

	Min	Max	Units
Surge Current, at 25°C		100	Arms
Leakage Current at 250 Vac, 400 Hz		10	mArms
Turn-On Time		1/2	cycle
Turn-Off Time		1	cycle
Zero Voltage Turn-On		±15	V pk
Load Power Factor	0.2		
dV/dt	100		V/μs
Transient Voltage, (t < 5s) (See Note 4)		±500	V pk
Thermal Trip Temperature (Case) (RA58HQ Only)	120	150	°C
Dielectric Strength (60 Hz)	1250		Vac
Insulation Resistance (@ 500 Vdc)	10 <sup>9</sup>		Ohm
Input to Output Capacitance		20	pF
Junction Temperature at Rated Current		125	°C
Thermal Resistance Junction to Case		0.7	°C/W
Thermal Resistance Junction to Ambient		16	°C/W

**STATUS OUTPUT TRUTH TABLE**

Status Output State	Control Input	Output (Load) State
Off (High)	Low	On
On (Low)	Low	Tripped
Off (High)	High	Off
On (Low)	High	Non-Applicable Condition

**STATUS OUTPUT SPECIFICATIONS**

	Min	Max	Units
Status Supply Voltage	3.8	32	Vdc
Status Leakage Current @ 32 Vdc		10	μAdc
Status Sink Current (V <sub>so</sub> ≤ 0.4 Vdc)		10	mAdc

**BLOCK DIAGRAM**

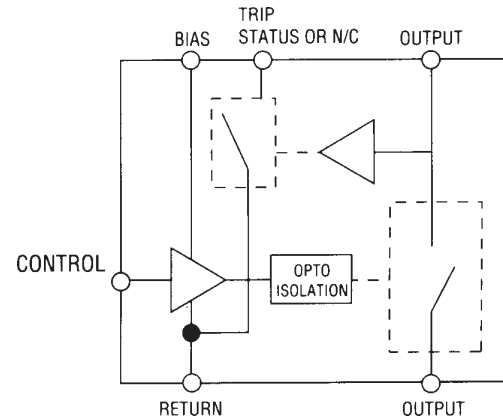

**MECHANICAL SPECIFICATIONS**

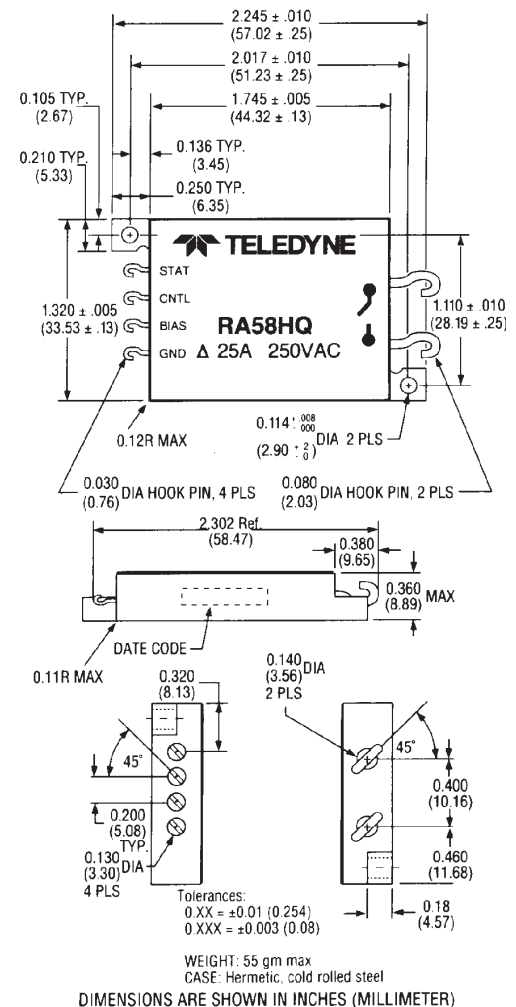

**ENVIRONMENTAL SPECIFICATIONS**

	Min	Max	Units
Temperature Range			
Operating	-55	+110	°C
Storage	-55	+125	°C
Vibration 30 g,	10	2000	Hz
Constant Acceleration		5000	g
Shock (6 ms)		100	g

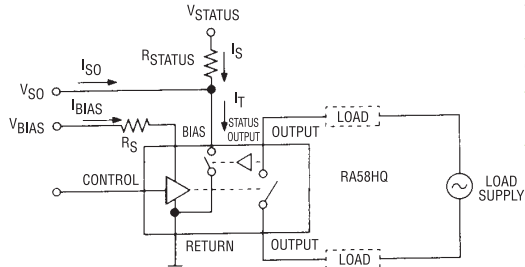

**(A) 3 TERMINAL INPUT WITH STATUS (See Note 5)**

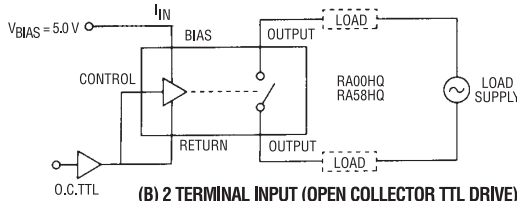

**(B) 2 TERMINAL INPUT (OPEN COLLECTOR TTL DRIVE)**

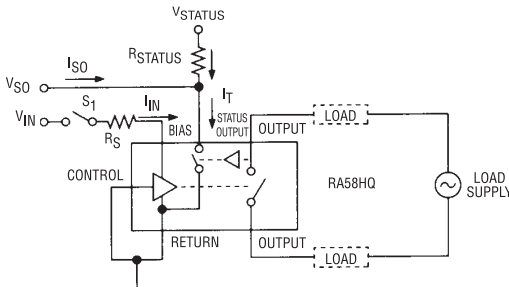

**(C) 2 TERMINAL INPUT (DIRECT DRIVE) WITH STATUS**

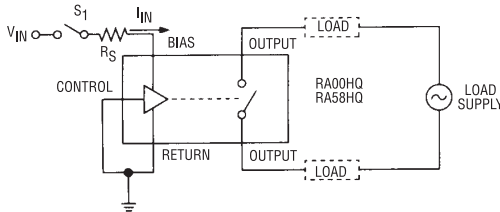

**(D) 2 TERMINAL INPUT (DIRECT DRIVE)**

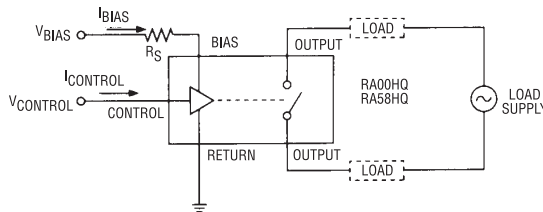

**(E) 3 TERMINAL INPUT WITHOUT STATUS**

**WIRING CONFIGURATION  
FIGURE 1 (See note 1 & 2)**

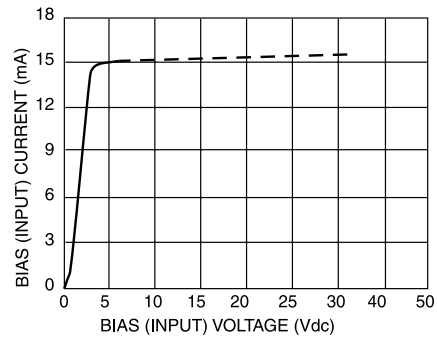

**INPUT CURRENT VS INPUT VOLTAGE FIGURE 2  
(See Note 2)**

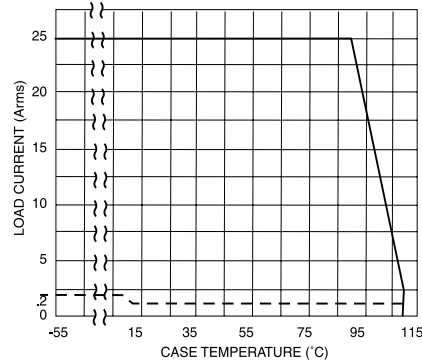

**RA SERIES WITH HEAT SINK  
(A)**

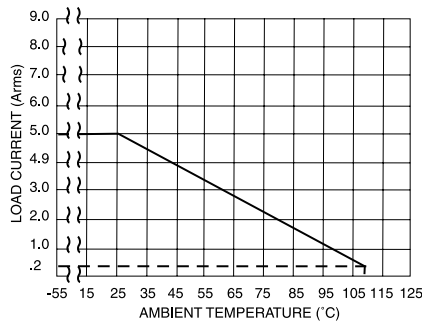

**RA SERIES WITHOUT HEAT SINK  
(B)**

**THERMAL DERATING CURVES  
FIGURE 3**

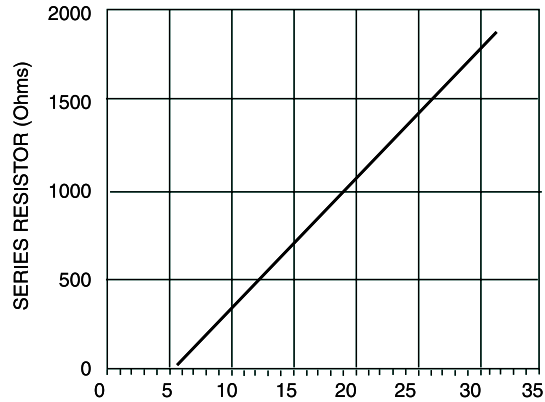

**SERIES LIMIT BIAS RESISTOR VS BIAS VOLTAGE  
FIGURE 4 (SEE NOTE 2)**

**NOTES:**

1. Control input is compatible with CMOS or open collector TTL (with pull up resistor).
2. For bias voltages above 6 Vdc, a series resistor is recommended. Use a standard resistor value equal to or less than the value found from Figure 5.
3. Unless otherwise noted, the input voltage for functional tests shall be 5 Vdc.
4. Transient suppression must be used to limit the voltage to < 500 Vpeak when switching inductive loads.
5. Control input implies presence of bias voltage.

## Данный компонент на территории Российской Федерации

### Вы можете приобрести в компании MosChip.

Для оперативного оформления запроса Вам необходимо перейти по данной ссылке:

<http://moschip.ru/get-element>

Вы можете разместить у нас заказ для любого Вашего проекта, будь то серийное производство или разработка единичного прибора.

В нашем ассортименте представлены ведущие мировые производители активных и пассивных электронных компонентов.

Нашей специализацией является поставка электронной компонентной базы двойного назначения, продукции таких производителей как XILINX, Intel (ex.ALTERA), Vicor, Microchip, Texas Instruments, Analog Devices, Mini-Circuits, Amphenol, Glenair.

Сотрудничество с глобальными дистрибьюторами электронных компонентов, предоставляет возможность заказывать и получать с международных складов практически любой перечень компонентов в оптимальные для Вас сроки.

На всех этапах разработки и производства наши партнеры могут получить квалифицированную поддержку опытных инженеров.

Система менеджмента качества компании отвечает требованиям в соответствии с ГОСТ Р ИСО 9001, ГОСТ РВ 0015-002 и ЭС РД 009

### Офис по работе с юридическими лицами:

105318, г.Москва, ул.Щербаковская д.3, офис 1107, 1118, ДЦ «Щербаковский»

Телефон: +7 495 668-12-70 (многоканальный)

Факс: +7 495 668-12-70 (доб.304)

E-mail: [info@moschip.ru](mailto:info@moschip.ru)

Skype отдела продаж:

moschip.ru

moschip.ru\_4

moschip.ru\_6

moschip.ru\_9