



The SST39VF801C / SST39VF802C / SST39LF801C / SST39LF802C are 512K x16 CMOS Multi-Purpose Flash Plus (MPF+) manufactured with SST proprietary, high performance CMOS SuperFlash® technology. The split-gate cell design and thick-oxide tunneling injector attain better reliability and manufacturability compared with alternate approaches. The SST39VF801C / SST39VF802C / SST39LF801C / SST39LF802C write (Program or Erase) with a 2.7-3.6V power supply. These devices conform to JEDEC standard pinouts for x16 memories.

Features

- **Organized as 512K x16**
- **Single Voltage Read and Write Operations**
 - 2.7-3.6V for SST39VF801C/802C
 - 3.0-3.6V for SST39LF801C/802C
- **Superior Reliability**
 - Endurance: 100,000 Cycles (Typical)
 - Greater than 100 years Data Retention
- **Low Power Consumption (typical values at 5 MHz)**
 - Active Current: 5 mA (typical)
 - Standby Current: 3 μ A (typical)
 - Auto Low Power Mode: 3 μ A (typical)
- **Hardware Block-Protection/WP# Input Pin**
 - Top Block-Protection (top 8 KWord)
 - Bottom Block-Protection (bottom 8 KWord)
- **Sector-Erase Capability**
 - Uniform 2 KWord sectors
- **Block-Erase Capability**
 - Flexible block architecture; one 8-, two 4-, one 16-, and fifteen 32-KWord blocks
- **Chip-Erase Capability**
- **Erase-Suspend/Erase-Resume Capabilities**
- **Hardware Reset Pin (RST#)**
- **Latched Address and Data**
- **Security-ID Feature**
 - SST: 128 bits; User: 128 words
- **Fast Read Access Time:**
 - 70 ns for SST39VF801C/802C
 - 55 ns for SST39LF801C/802C
- **Fast Erase and Word-Program:**
 - Sector-Erase Time: 18 ms (typical)
 - Block-Erase Time: 18 ms (typical)
 - Chip-Erase Time: 40 ms (typical)
 - Word-Program Time: 7 μ s (typical)
- **Automatic Write Timing**
 - Internal V_{PP} Generation
- **End-of-Write Detection**
 - Toggle Bits
 - Data# Polling
 - Ready/Busy# Pin
- **CMOS I/O Compatibility**
- **JEDEC Standard**
 - Flash EEPROM Pinouts and command sets
- **Packages Available**
 - 48-lead TSOP (12mm x 20mm)
 - 48-ball TFBGA (6mm x 8mm)
 - 48-ball WFBGA (4mm x 6mm)
- **All devices are RoHS compliant**



Product Description

The SST39VF801C/802C and SST39LF801C/802C devices are 512K x16 CMOS Multi-Purpose Flash Plus (MPF+) manufactured with SST proprietary, high performance CMOS SuperFlash technology. The split-gate cell design and thick-oxide tunneling injector attain better reliability and manufacturability compared with alternate approaches. The SST39VF801C/802C and SST39LF801C/802C write (Program or Erase) with a 2.7-3.6V power supply. These devices conform to JEDEC standard pinouts for x16 memories.

Featuring high performance Word-Program, the SST39VF801C/802C and SST39LF801C/802C devices provide a typical Word-Program time of 7 μ sec. These devices use Toggle Bit, Data# Polling, or the RY/BY# pin to indicate the completion of Program operation. To protect against inadvertent write, they have on-chip hardware and Software Data Protection schemes. Designed, manufactured, and tested for a wide spectrum of applications, these devices are offered with a guaranteed typical endurance of 100,000 cycles. Data retention is rated at greater than 100 years.

The SST39VF801C/802C and SST39LF801C/802C devices are suited for applications that require convenient and economical updating of program, configuration, or data memory. For all system applications, they significantly improve performance and reliability, while lowering power consumption. They inherently use less energy during Erase and Program than alternative flash technologies. The total energy consumed is a function of the applied voltage, current, and time of application. Since for any given voltage range, the SuperFlash technology uses less current to program and has a shorter erase time, the total energy consumed during any Erase or Program operation is less than alternative flash technologies. These devices also improve flexibility while lowering the cost for program, data, and configuration storage applications.

The SuperFlash technology provides fixed Erase and Program times, independent of the number of Erase/Program cycles that have occurred. Therefore the system software or hardware does not have to be modified or de-rated as is necessary with alternative flash technologies, whose Erase and Program times increase with accumulated Erase/Program cycles.

To meet high density, surface mount requirements, the SST39VF801C/802C and SST39LF801C/802C are offered in 48-lead TSOP, 48-ball TFBGA, and 48-ball WFBGA packages. See Figures 2, 3, and 4 for pin assignments.



Block Diagrams

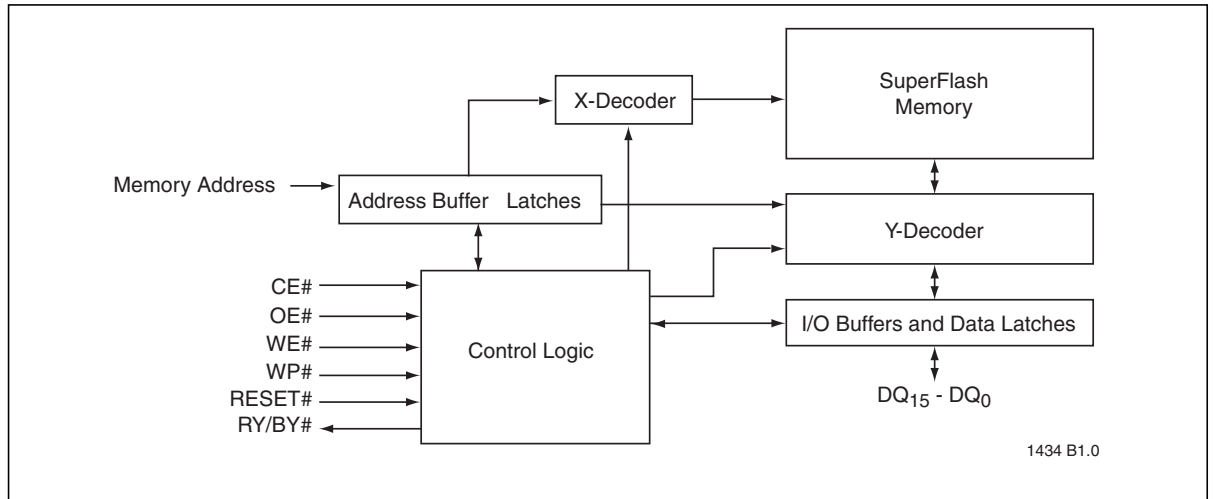

Figure 1: Functional Block Diagram



Pin Assignment

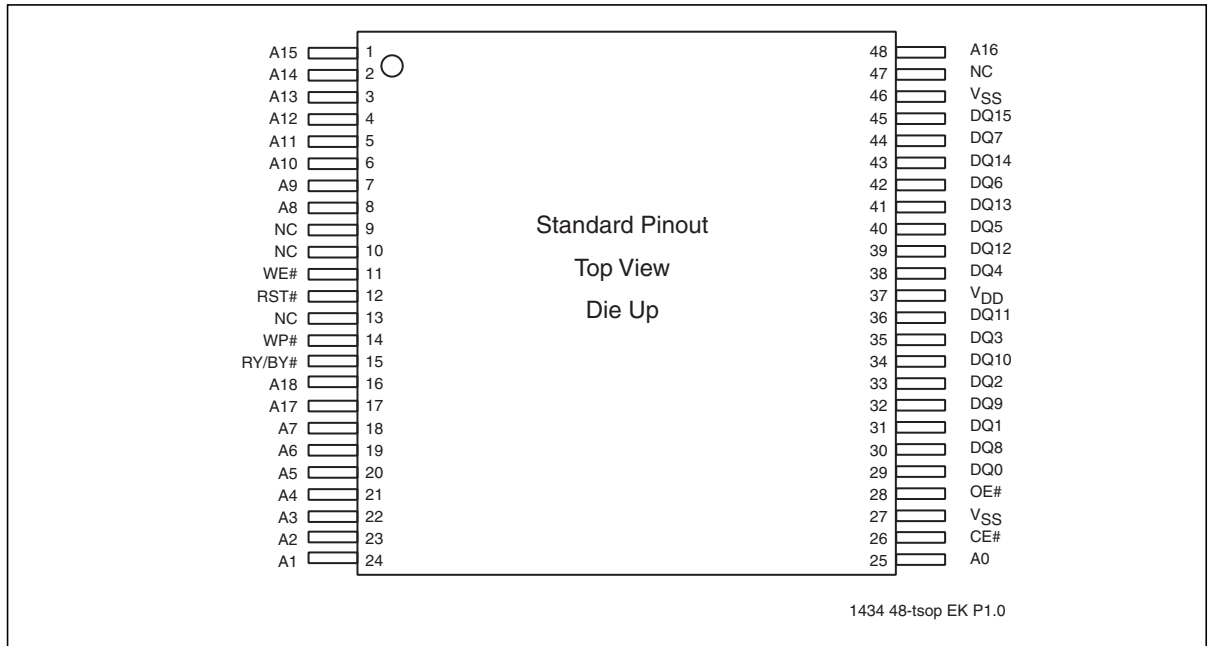

Figure 2: Pin Assignments for 48-Lead TSOP

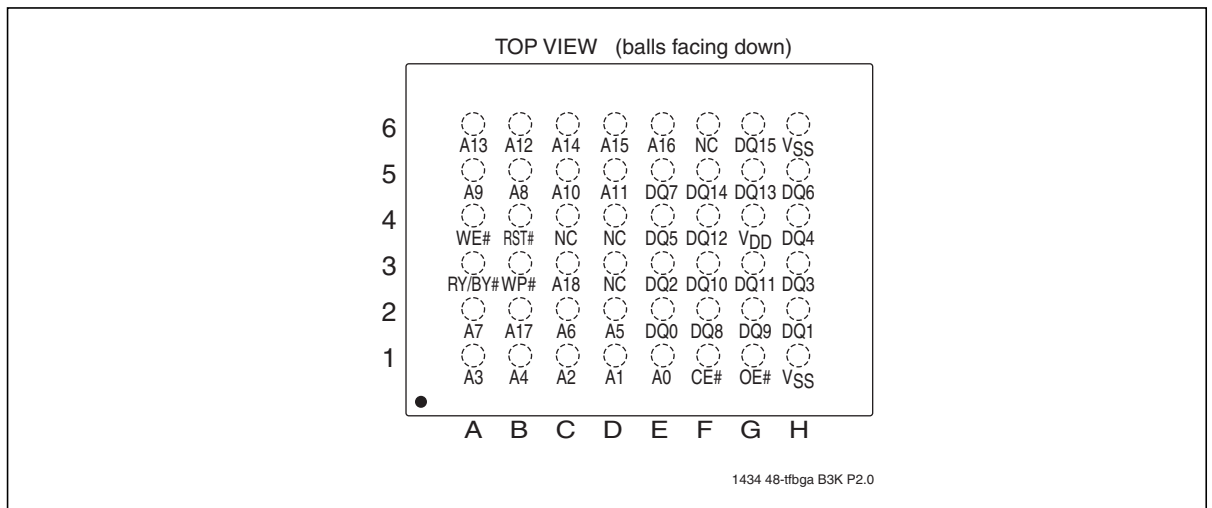

Figure 3: Pin Assignments for 48-Ball TFBGA

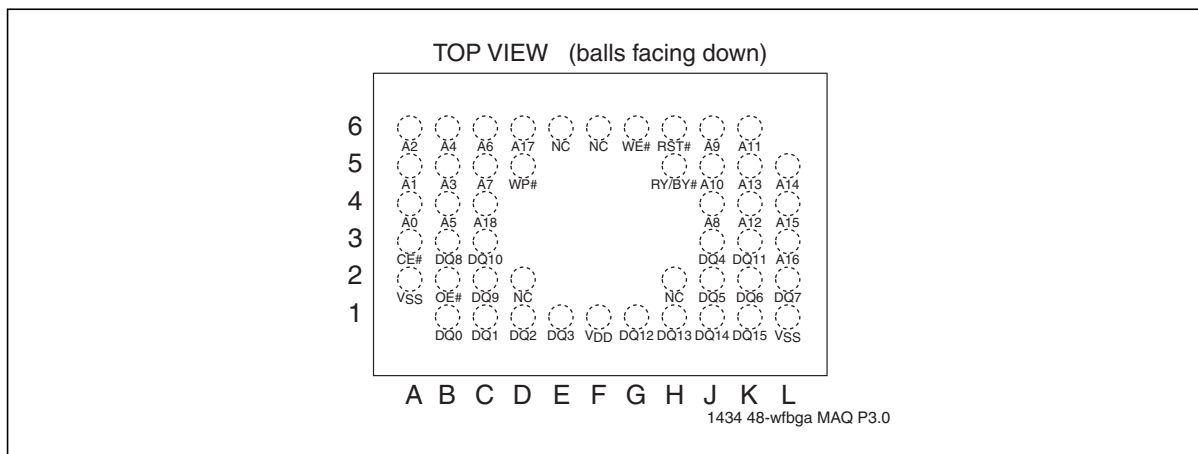

Figure 4: Pin Assignments for 48-Ball WFBGA

Table 1: Pin Description

Symbol	Pin Name	Functions
A_{MS}^1 -A ₀	Address Inputs	To provide memory addresses. During Sector-Erase A_{MS} -A ₁₁ address lines will select the sector. During Block-Erase A_{MS} -A ₁₅ address lines will select the block.
DQ ₁₅ -DQ ₀	Data Input/output	To output data during Read cycles and receive input data during Write cycles. Data is internally latched during a Write cycle. The outputs are in tri-state when OE# or CE# is high.
WP#	Write Protect	To protect the top/bottom boot block from Erase/Program operation when grounded.
RST#	Reset	To reset and return the device to Read mode.
CE#	Chip Enable	To activate the device when CE# is low.
OE#	Output Enable	To gate the data output buffers.
WE#	Write Enable	To control the Write operations.
V _{DD}	Power Supply	To provide power supply voltage: 2.7-3.6V
V _{SS}	Ground	
NC	No Connection	Unconnected pins.
RY/BY#	Ready/Busy#	To output the status of a Program or Erase operation RY/BY# is an open drain output, so a 10KΩ - 100KΩ pull-up resistor is required to allow RY/BY# to transition high indicating the device is ready to read.

T1.2.25041

1. A_{MS} = Most significant address
 A_{MS} = A₁₈



8 Mbit (x16) Multi-Purpose Flash Plus

SST39VF801C / SST39VF802C / SST39LF801C / SST39LF802C

Table 2: Top / Bottom Boot Block Address

Top Boot Block Address SST39VF802C/SST39LF802C		
#	Size (KWord)	Address Range
18	8	7E000H-7FFFFH
17	4	7D000H-7DFFFH
16	4	7C000H-7CFFFH
15	16	78000H-7BFFFH
14	32	70000H-77FFFH
13	32	68000H-6FFFFH
12	32	60000H-67FFFH
11	32	58000H-5FFFFH
10	32	50000H-57FFFH
9	32	48000H-47FFFH
8	32	40000H-47FFFH
7	32	38000H-3FFFFH
6	32	30000H-37FFFH
5	32	28000H-2FFFFH
4	32	20000H-27FFFH
3	32	18000H-1FFFFH
2	32	10000H-17FFFH
1	32	08000H-0FFFFH
0	32	00000H-07FFFH

Bottom Boot Block Address SST39VF801C/SST39LF801C		
#	Size (KWord)	Address Range
18	32	78000H-7FFFFH
17	32	70000H-77FFFH
16	32	68000H-6FFFFH
15	32	60000H-67FFFH
14	32	58000H-5FFFFH
13	32	50000H-57FFFH
12	32	48000H-47FFFH
11	32	40000H-47FFFH
10	32	38000H-3FFFFH
9	32	30000H-37FFFH
8	32	28000H-2FFFFH
7	32	20000H-27FFFH
6	32	18000H-1FFFFH
5	32	10000H-17FFFH
4	32	08000H-0FFFFH
3	16	04000H-07FFFH
2	4	03000H-03FFFH
1	4	02000H-02FFFH
0	8	00000H-01FFFH

T2.25041



Device Operation

Commands are used to initiate the memory operation functions of the device. Commands are written to the device using standard microprocessor write sequences. A command is written by asserting WE# low while keeping CE# low. The address bus is latched on the falling edge of WE# or CE#, whichever occurs last. The data bus is latched on the rising edge of WE# or CE#, whichever occurs first.

The SST39VF801C/802C and SST39LF801C/802C also have the Auto Low Power mode which puts the device in a near standby mode after data has been accessed with a valid Read operation. This reduces the I_{DD} active read current from typically 5 mA to typically 3 μ A. The Auto Low Power mode reduces the typical I_{DD} active read current to the range of 2 mA/MHz of Read cycle time. The device exits the Auto Low Power mode with any address transition or control signal transition used to initiate another Read cycle, with no access time penalty. Note that the device does not enter Auto-Low Power mode after power-up with CE# held steadily low, until the first address transition or CE# is driven high.

Read

The Read operation of the SST39VF801C/802C and SST39LF801C/802C is controlled by CE# and OE#, both have to be low for the system to obtain data from the outputs. CE# is used for device selection. When CE# is high, the chip is deselected and only standby power is consumed. OE# is the output control and is used to gate data from the output pins. The data bus is in high impedance state when either CE# or OE# is high. Refer to the Read cycle timing diagram for further details (Figure 6).

Word-Program Operation

The SST39VF801C/802C and SST39LF801C/802C are programmed on a word-by-word basis. Before programming, the sector where the word exists must be fully erased. The Program operation is accomplished in three steps. The first step is the three-byte load sequence for Software Data Protection. The second step is to load word address and word data. During the Word-Program operation, the addresses are latched on the falling edge of either CE# or WE#, whichever occurs last. The data is latched on the rising edge of either CE# or WE#, whichever occurs first. The third step is the internal Program operation which is initiated after the rising edge of the fourth WE# or CE#, whichever occurs first. The Program operation, once initiated, will be completed within 10 μ s. See Figures 7 and 8 for WE# and CE# controlled Program operation timing diagrams and Figure 22 for flowcharts. During the Program operation, the only valid reads are Data# Polling and Toggle Bit. During the internal Program operation, the host is free to perform additional tasks. Any commands issued during the internal Program operation are ignored. During the command sequence, WP# should be statically held high or low.

Sector/Block-Erase Operation

The Sector- (or Block-) Erase operation allows the system to erase the device on a sector-by-sector (or block-by-block) basis. The SST39VF801C/802C and SST39LF801C/802C offer both Sector-Erase and Block-Erase mode.

The sector architecture is based on a uniform sector size of 2 KWord. The Block-Erase mode is based on non-uniform block sizes—fifteen 32 KWord, one 16 KWord, two 4 KWord, and one 8 KWord blocks. See Figure 2 for top and bottom boot device block addresses. The Sector-Erase operation is initiated by executing a six-byte command sequence with Sector-Erase command (50H) and sector address (SA) in the last bus cycle. The Block-Erase operation is initiated by executing a six-byte command sequence with Block-Erase command (30H) and block address (BA) in the last bus cycle. The sector or block address is latched on the falling edge of the sixth WE# pulse, while the command (30H or 50H) is latched on the rising edge of the sixth WE# pulse. The internal Erase operation begins after the



sixth WE# pulse. The End-of-Erase operation can be determined using either Data# Polling or Toggle Bit methods. See Figures 12 and 13 for timing waveforms and Figure 26 for the flowchart. Any commands issued during the Sector- or Block-Erase operation are ignored. When WP# is low, any attempt to Sector- (Block-) Erase the protected block will be ignored. During the command sequence, WP# should be statically held high or low.

Erase-Suspend/Erase-Resume Commands

The Erase-Suspend operation temporarily suspends a Sector- or Block-Erase operation thus allowing data to be read from any memory location, or program data into any sector/block that is not suspended for an Erase operation. The operation is executed by issuing one byte command sequence with Erase-Suspend command (B0H). The device automatically enters read mode typically within 20 μ s after the Erase-Suspend command had been issued. Valid data can be read from any sector or block that is not suspended from an Erase operation. Reading at address location within erase-suspended sectors/blocks will output DQ₂ toggling and DQ₆ at '1'. While in Erase-Suspend mode, a Word-Program operation is allowed except for the sector or block selected for Erase-Suspend.

To resume Sector-Erase or Block-Erase operation which has been suspended the system must issue Erase Resume command. The operation is executed by issuing one byte command sequence with Erase Resume command (30H) at any address in the last Byte sequence.

Chip-Erase Operation

The SST39VF801C/802C and SST39LF801C/802C provide a Chip-Erase operation, which allows the user to erase the entire memory array to the '1' state. This is useful when the entire device must be quickly erased.

The Chip-Erase operation is initiated by executing a six-byte command sequence with Chip-Erase command (10H) at address 555H in the last byte sequence. The Erase operation begins with the rising edge of the sixth WE# or CE#, whichever occurs first. During the Erase operation, the only valid read is Toggle Bit or Data# Polling. See Table 7 for the command sequence, Figure 11 for timing diagram, and Figure 26 for the flowchart. Any commands issued during the Chip-Erase operation are ignored. When WP# is low, any attempt to Chip-Erase will be ignored. During the command sequence, WP# should be statically held high or low.

Write Operation Status Detection

The SST39VF801C/802C and SST39LF801C/802C provide two software means to detect the completion of a Write (Program or Erase) cycle, in order to optimize the system write cycle time. The software detection includes two status bits: Data# Polling (DQ₇) and Toggle Bit (DQ₆). The End-of-Write detection mode is enabled after the rising edge of WE#, which initiates the internal Program or Erase operation.

The actual completion of the nonvolatile write is asynchronous with the system; therefore, either a Data# Polling or Toggle Bit read may be simultaneous with the completion of the write cycle. If this occurs, the system may possibly get an erroneous result, i.e., valid data may appear to conflict with either DQ₇ or DQ₆. In order to prevent spurious rejection, if an erroneous result occurs, the software routine should include a loop to read the accessed location an additional two (2) times. If both reads are valid, then the device has completed the Write cycle, otherwise the rejection is valid.



Ready/Busy# (RY/BY#)

The devices include a Ready/Busy# (RY/BY#) output signal. RY/BY# is an open drain output pin that indicates whether an Erase or Program operation is in progress. Since RY/BY# is an open drain output, it allows several devices to be tied in parallel to V_{DD} via an external pull-up resistor. After the rising edge of the final WE# pulse in the command sequence, the RY/BY# status is valid.

When RY/BY# is actively pulled low, it indicates that an Erase or Program operation is in progress. When RY/BY# is high (Ready), the devices may be read or left in standby mode.

Data# Polling (DQ₇)

When the SST39VF801C/802C and SST39LF801C/802C are in the internal Program operation, any attempt to read DQ₇ will produce the complement of the true data. Once the Program operation is completed, DQ₇ will produce true data. Note that even though DQ₇ may have valid data immediately following the completion of an internal Write operation, the remaining data outputs may still be invalid: valid data on the entire data bus will appear in subsequent successive Read cycles after an interval of 1 μ s. During internal Erase operation, any attempt to read DQ₇ will produce a '0'. Once the internal Erase operation is completed, DQ₇ will produce a '1'. The Data# Polling is valid after the rising edge of fourth WE# (or CE#) pulse for Program operation. For Sector-, Block- or Chip-Erase, the Data# Polling is valid after the rising edge of sixth WE# (or CE#) pulse. See Figure 9 for Data# Polling timing diagram and Figure 23 for a flowchart.

Toggle Bits (DQ₆ and DQ₂)

During the internal Program or Erase operation, any consecutive attempts to read DQ₆ will produce alternating '1's and '0's, i.e., toggling between 1 and 0. When the internal Program or Erase operation is completed, the DQ₆ bit will stop toggling. The device is then ready for the next operation. For Sector-, Block-, or Chip-Erase, the toggle bit (DQ₆) is valid after the rising edge of sixth WE# (or CE#) pulse. DQ₆ will be set to '1' if a Read operation is attempted on an Erase-Suspended Sector/Block. If Program operation is initiated in a sector/block not selected in Erase-Suspend mode, DQ₆ will toggle.

An additional Toggle Bit is available on DQ₂, which can be used in conjunction with DQ₆ to check whether a particular sector is being actively erased or erase-suspended. Table 3 shows detailed status bits information. The Toggle Bit (DQ₂) is valid after the rising edge of the last WE# (or CE#) pulse of Write operation. See Figure 10 for Toggle Bit timing diagram and Figure 23 for a flowchart.

Table 3: Write Operation Status

Status		DQ ₇	DQ ₆	DQ ₂	RY/BY#
Normal Operation	Standard Program	DQ ₇ #	Toggle	No Toggle	0
	Standard Erase	0	Toggle	Toggle	0
Erase-Suspend Mode	Read from Erase-Suspended Sector/Block	1	1	Toggle	1
	Read from Non-Erase-Suspended Sector/Block	Data	Data	Data	1
	Program	DQ ₇ #	Toggle	N/A	0

T3.0 25041

Note: DQ₇ and DQ₂ require a valid address when reading status information.



Data Protection

The SST39VF801C/802C and SST39LF801C/802C provide both hardware and software features to protect nonvolatile data from inadvertent writes.

Hardware Data Protection

Noise/Glitch Protection: A WE# or CE# pulse of less than 5 ns will not initiate a write cycle.

V_{DD} Power Up/Down Detection: The Write operation is inhibited when V_{DD} is less than 1.5V.

Write Inhibit Mode: Forcing OE# low, CE# high, or WE# high will inhibit the Write operation. This prevents inadvertent writes during power-up or power-down.

Hardware Block Protection

The SST39VF802C/SST39LF802C support top hardware block protection, which protects the top 8 KWord block of the device. The SST39VF801C/SST39LF801C support bottom hardware block protection, which protects the bottom 8KWord block of the device. The Boot Block address ranges are described in Table 4. Program and Erase operations are prevented on the 8 KWord when WP# is low. If WP# is left floating, it is internally held high via a pull-up resistor, and the Boot Block is unprotected, enabling Program and Erase operations on that block.

Table 4: Boot Block Address Ranges

Product	Address Range
Bottom Boot Block SST39VF801C/SST39LF801C	00000H - 01FFFFH
Top Boot Block SST39VF802C/SST39LF802C	7E000H - 7FFFFFFH

T4.0 25041

Hardware Reset (RST#)

The RST# pin provides a hardware method of resetting the device to read array data. When the RST# pin is held low for at least T_{RP}, any in-progress operation will terminate and return to Read mode. When no internal Program/Erase operation is in progress, a minimum period of T_{RHR} is required after RST# is driven high before a valid Read can take place (see Figure 18).

The Erase or Program operation that has been interrupted needs to be re-initiated after the device resumes normal operation mode to ensure data integrity.

Software Data Protection (SDP)

The SST39VF801C/802C and SST39LF801C/802C provide the JEDEC approved Software Data Protection scheme for all data alteration operations, i.e., Program and Erase. Any Program operation requires the inclusion of the three-byte sequence. The three-byte load sequence is used to initiate the Program operation, providing optimal protection from inadvertent Write operations, e.g., during the system power-up or power-down. Any Erase operation requires the inclusion of six-byte sequence. These devices are shipped with the Software Data Protection permanently enabled. See Table 7 for



the specific software command codes. During SDP command sequence, invalid commands will abort the device to read mode within T_{RC} . The contents of DQ_{15} - DQ_8 can be V_{IL} or V_{IH} , but no other value, during any SDP command sequence.

Common Flash Memory Interface (CFI)

The SST39VF801C/802C and SST39LF801C/802C also contain the CFI information to describe the characteristics of the device. In order to enter the CFI Query mode, the system writes a three-byte sequence, same as product ID entry command with 98H (CFI Query command) to address 555H in the last byte sequence. Additionally, the system can use the one-byte sequence with 55H on the Address and 89H on the Data Bus to enter the CFI Query mode. Once the device enters the CFI Query mode, the system can read CFI data at the addresses given in Tables 8 through 10. The system must write the CFI Exit command to return to Read mode from the CFI Query mode.

Product Identification

The Product Identification mode identifies the devices as the SST39VF801C / SST39VF802C / SST39LF801C / SST39LF802C, and manufacturer as SST. This mode may be accessed software operations. Users may use the Software Product Identification operation to identify the part (i.e., using the device ID) when using multiple manufacturers in the same socket. For details, see Table 7 for software operation, Figure 14 for the Software ID Entry and Read timing diagram and Figure 24 for the Software ID Entry command sequence flowchart.

Table 5: Product Identification

	Address	Data
Manufacturer's ID	0000H	BFH
Device ID		
SST39VF801C/SST39LF801C	0001H	233BH
SST39VF802C/SST39LF802C	0001H	233AH

T5.2 25041

Product Identification Mode Exit/CFI Mode Exit

In order to return to the standard Read mode, the Software Product Identification mode must be exited. Exit is accomplished by issuing the Software ID Exit command sequence, which returns the device to the Read mode. This command may also be used to reset the device to the Read mode after any inadvertent transient condition that apparently causes the device to behave abnormally, e.g., not read correctly. Please note that the Software ID Exit/CFI Exit command is ignored during an internal Program or Erase operation. See Table 7 for software command codes, Figure 16 for timing waveform, and Figure 25 for flowcharts.



Security ID

The SST39VF801C/802C and SST39LF801C/802C devices offer a 136 Word Security ID space. The Secure ID space is divided into two segments—one factory programmed segment and one user programmed segment. The first segment is programmed and locked at SST with a random 128-bit number. The user segment, with a 128 word space, is left un-programmed for the customer to program as desired.

To program the user segment of the Security ID, the user must use the Security ID Word-Program command. To detect end-of-write for the SEC ID, read the toggle bits. Do not use Data# Polling. Once this is complete, the Sec ID should be locked using the User Sec ID Program Lock-Out. This disables any future corruption of this space. Note that regardless of whether or not the Sec ID is locked, neither Sec ID segment can be erased.

The Secure ID space can be queried by executing a three-byte command sequence with Enter Sec ID command (88H) at address 555H in the last byte sequence. To exit this mode, the Exit Sec ID command should be executed. Refer to Table 7 for more details.



Operations

Table 6: Operation Modes Selection

Mode	CE#	OE#	WE#	DQ	Address
Read	V _{IL}	V _{IL}	V _{IH}	D _{OUT}	A _{IN}
Program	V _{IL}	V _{IH}	V _{IL}	D _{IN}	A _{IN}
Erase	V _{IL}	V _{IH}	V _{IL}	X ¹	Sector or block address, XXH for Chip-Erase
Standby	V _{IH}	X	X	High Z	X
Write Inhibit	X	V _{IL}	X	High Z/ D _{OUT}	X
	X	X	V _{IH}	High Z/ D _{OUT}	X
Product Identification					
Software Mode	V _{IL}	V _{IL}	V _{IH}		See Table 7

T6.0 25041

1. X can be V_{IL} or V_{IH}, but no other value.

Table 7: Software Command Sequence

Command Sequence	1st Bus Write Cycle		2nd Bus Write Cycle		3rd Bus Write Cycle		4th Bus Write Cycle		5th Bus Write Cycle		6th Bus Write Cycle	
	Addr ¹	Data ²	Addr ¹	Data ²	Addr ¹	Data ²	Addr ¹	Data ²	Addr ¹	Data ²	Addr ¹	Data ²
Word-Program	555H	AAH	2AAH	55H	555H	A0H	WA ³	Data				
Sector-Erase	555H	AAH	2AAH	55H	555H	80H	555H	AAH	2AAH	55H	SA _X ⁴	50H
Block-Erase	555H	AAH	2AAH	55H	555H	80H	555H	AAH	2AAH	55H	BA _X ⁴	30H
Chip-Erase	555H	AAH	2AAH	55H	555H	80H	555H	AAH	2AAH	55H	555H	10H
Erase-Suspend	XXXH	B0H										
Erase-Resume	XXXH	30H										
Query Sec ID ⁵	555H	AAH	2AAH	55H	555H	88H						
User Security ID Word-Program	555H	AAH	2AAH	55H	555H	A5H	WA ⁶	Data				
User Security ID Program Lock-Out	555H	AAH	2AAH	55H	555H	85H	XXH ⁶	0000 H				
Software ID Entry ^{7,8}	555H	AAH	2AAH	55H	555H	90H						
CFI Query Entry	555H	AAH	2AAH	55H	555H	98H						
CFI Query Entry	55H	98H										
Software ID Exit ^{9,10} /CFI Exit/Sec ID Exit	555H	AAH	2AAH	55H	555H	F0H						
Software ID Exit ^{9,10} /CFI Exit/Sec ID Exit	XXH	F0H										

T7.6 25041

1. Address format A₁₀-A₀ (Hex). Addresses A₁₁-A₁₈ can be V_{IL} or V_{IH}, but no other value, for Command sequence.
2. DQ₁₅-DQ₈ can be V_{IL} or V_{IH}, but no other value, for Command sequence
3. WA = Program Word address
4. SA_X for Sector-Erase; uses A_{MS}-A₁₁ address lines
BA_X, for Block-Erase; uses A_{MS}-A₁₅ address lines
A_{MS} = Most significant address; A_{MS} = A₁₈



8 Mbit (x16) Multi-Purpose Flash Plus

SST39VF801C / SST39VF802C / SST39LF801C / SST39LF802C

5. With $A_{MS}-A_4 = 0$; Sec ID is read with A_3-A_0 ,
 SST ID is read with $A_3 = 0$ (Address range = 000000H to 000007H),
 User ID is read with $A_3 = 1$ (Address range = 000008H to 000007H).
 Lock Status is read with $A_7-A_0 = 0000FFH$. Unlocked: $DQ_3 = 1$ / Locked: $DQ_3 = 0$.
6. Valid Word-Addresses for Sec ID are from 000000H-000007H and 000008H-000007H.
7. The device does not remain in Software Product ID Mode if powered down.
8. With $A_{MS}-A_1 = 0$; SST Manufacturer ID = 00BFH, is read with $A_0 = 0$,
 SST39VF801C/SST39LF801C Device ID = 233BH, is read with $A_0 = 1$, SST39VF802C/SST39LF802C Device ID =
 233AH, is read with $A_0 = 1$,
 A_{MS} = Most significant address; $A_{MS} = A_{18}$
9. Both Software ID Exit operations are equivalent
10. If users never lock after programming, Sec ID can be programmed over the previously unprogrammed bits (data=1) using the Sec ID mode again (the programmed '0' bits cannot be reversed to '1'). Valid Word-Addresses for Sec ID are from 000000H-000007H and 000008H-000007H.

Table 8: CFI Query Identification String¹

Address	Data	Data
10H	0051H	Query Unique ASCII string "QRY"
11H	0052H	
12H	0059H	
13H	0002H	Primary OEM command set
14H	0000H	
15H	0000H	Address for Primary Extended Table
16H	0000H	
17H	0000H	Alternate OEM command set (00H = none exists)
18H	0000H	
19H	0000H	Address for Alternate OEM extended Table (00H = none exists)
1AH	0000H	

T8.1 25041

1. Refer to CFI publication 100 for more details.

Table 9: System Interface Information

Address	Data	Data
1BH	0027H	V_{DD} Min (Program/Erase) DQ_7-DQ_4 : Volts, DQ_3-DQ_0 : 100 millivolts
1CH	0036H	V_{DD} Max (Program/Erase) DQ_7-DQ_4 : Volts, DQ_3-DQ_0 : 100 millivolts
1DH	0000H	V_{PP} min. (00H = no V_{PP} pin)
1EH	0000H	V_{PP} max. (00H = no V_{PP} pin)
1FH	0003H	Typical time out for Word-Program $2^N \mu s$ ($2^3 = 8 \mu s$)
20H	0000H	Typical time out for min. size buffer program $2^N \mu s$ (00H = not supported)
21H	0004H	Typical time out for individual Sector/Block-Erase $2^N ms$ ($2^4 = 16 ms$)
22H	0005H	Typical time out for Chip-Erase $2^N ms$ ($2^5 = 32 ms$)
23H	0001H	Maximum time out for Word-Program 2^N times typical ($2^1 \times 2^3 = 16 \mu s$)
24H	0000H	Maximum time out for buffer program 2^N times typical
25H	0001H	Maximum time out for individual Sector/Block-Erase 2^N times typical ($2^1 \times 2^4 = 32 ms$)
26H	0001H	Maximum time out for Chip-Erase 2^N times typical ($2^1 \times 2^5 = 64 ms$)

T9.3 25041



8 Mbit (x16) Multi-Purpose Flash Plus

SST39VF801C / SST39VF802C / SST39LF801C / SST39LF802C

Table 10: Device Geometry Information

Address	Data	Data
27H	0014H	Device size = 2 ^N Bytes (14H = 20; 2 ²⁰ = 1 MByte)
28H	0001H	Flash Device Interface description; 0001H = x16-only asynchronous interface
29H	0000H	
2AH	0000H	Maximum number of byte in multi-byte write = 2 ^N (00H = not supported)
2BH	0000H	
2CH	0005H	Number of Erase Sector/Block sizes supported by device
2DH	0000H	Erase Block Region 1 Information (Refer to the CFI specification or CFI publication 100)
2EH	0000H	
2FH	0040H	
30H	0000H	
31H	0001H	Erase Block Region 2 Information
32H	0000H	
33H	0020H	
34H	0000H	
35H	0000H	Erase Block Region 3 Information
36H	0000H	
37H	0080H	
38H	0000H	
39H	000FH	Erase Block Region 4 Information
3AH	0000H	
3BH	0000H	
3CH	0001H	

T10.0 25041



Electrical Specifications

Absolute Maximum Stress Ratings (Applied conditions greater than those listed under “Absolute Maximum Stress Ratings” may cause permanent damage to the device. This is a stress rating only and functional operation of the device at these conditions or conditions greater than those defined in the operational sections of this data sheet is not implied. Exposure to absolute maximum stress rating conditions may affect device reliability.)

- Temperature Under Bias -55°C to +125°C
- Storage Temperature -65°C to +150°C
- D. C. Voltage on Any Pin to Ground Potential -0.5V to V_{DD}+0.5V
- Transient Voltage (<20 ns) on Any Pin to Ground Potential -2.0V to V_{DD}+2.0V
- Voltage on A₉ Pin to Ground Potential -0.5V to 13.2V
- Package Power Dissipation Capability (T_A = 25°C) 1.0W
- Surface Mount Solder Reflow 260°C for 10 seconds
- Output Short Circuit Current¹ 50 mA

1. Outputs shorted for no more than one second. No more than one output shorted at a time.

Table 11: Operating Range

Range	Ambient Temp	V _{DD}
Commercial	0°C to +70°C	2.7-3.6V
Industrial	-40°C to +85°C	2.7-3.6V

T11.0 25041

Table 12: AC Conditions of Test¹

Input Rise/Fall Time	Output Load
5ns	C _L = 30 pF

T12.1 25041

1. See Figures 20 and 21



Power Up Specifications

All functionalities and DC specifications are specified for a V_{DD} ramp rate of greater than 1V per 100 ms (0V to 3V in less than 300 ms). If the V_{DD} ramp rate is slower than 1V per 100 ms, a hardware reset is required. The recommended V_{DD} power-up to RESET# high time should be greater than 100 μ s to ensure a proper reset.

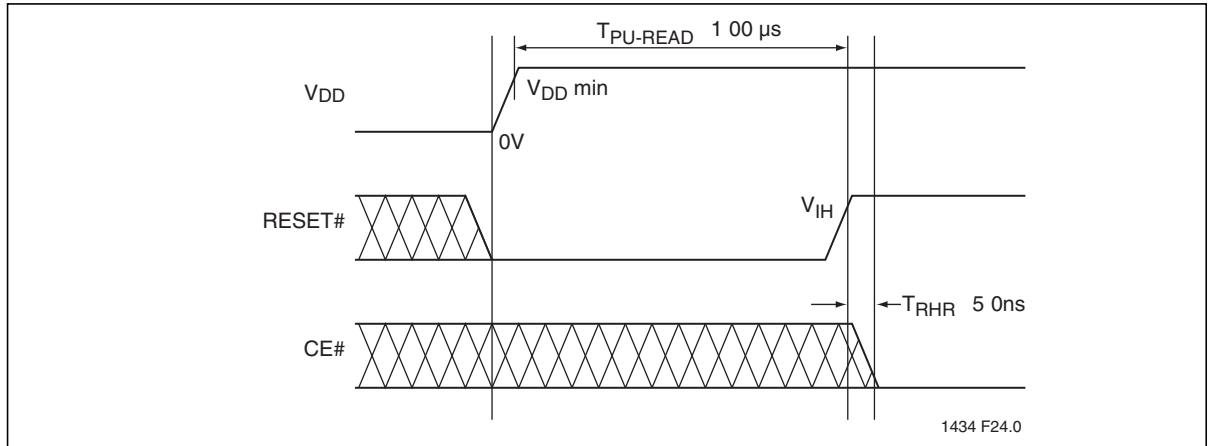

Figure 5: Power-Up Diagram

Table 13: DC Operating Characteristics $V_{DD} = 2.7-3.6V^1$

Symbol	Parameter	Limits			Test Conditions
		Min	Max	Units	
I_{DD}	Power Supply Current				Address input= V_{ILT}/V_{IHT}^2 , at f=5 MHz, $V_{DD}=V_{DD} \text{ Max}$
	Read ³		18	mA	$CE\#=V_{IL}$, $OE\#=WE\#=V_{IH}$, all I/Os open
	Program and Erase		30	mA	$CE\#=WE\#=V_{IL}$, $OE\#=V_{IH}$
I_{SB}	Standby V_{DD} Current		20	μ A	$CE\#=V_{IHC}$, $V_{DD}=V_{DD} \text{ Max}$ $RST\#=V_{DD}\pm 0.3$, $WP\#=V_{DD}\pm 0.3$, $WE\#=V_{DD}\pm 0.3$
I_{ALP}	Auto Low Power		20	μ A	$CE\#=V_{ILC}$, $V_{DD}=V_{DD} \text{ Max}$ All inputs= V_{SS} or V_{DD} , $WE\#=V_{IHC}$
I_{LI}	Input Leakage Current		1	μ A	$V_{IN}=\text{GND to } V_{DD}$, $V_{DD}=V_{DD} \text{ Max}$
I_{LIW}	Input Leakage Current on WP# pin and RST#		10	μ A	$WP\#=\text{GND to } V_{DD}$ or $RST\#=\text{GND to } V_{DD}$
I_{LO}	Output Leakage Current		10	μ A	$V_{OUT}=\text{GND to } V_{DD}$, $V_{DD}=V_{DD} \text{ Max}$
V_{IL}	Input Low Voltage		0.8	V	$V_{DD}=V_{DD} \text{ Min}$
V_{ILC}	Input Low Voltage (CMOS)		0.3	V	$V_{DD}=V_{DD} \text{ Max}$
V_{IH}	Input High Voltage	$0.7V_{DD}$	$V_{DD}+0.3$	V	$V_{DD}=V_{DD} \text{ Max}$
V_{IHC}	Input High Voltage (CMOS)	$V_{DD}-0.3$	$V_{DD}+0.3$	V	$V_{DD}=V_{DD} \text{ Max}$
V_{OL}	Output Low Voltage		0.2	V	$I_{OL}=100 \mu\text{A}$, $V_{DD}=V_{DD} \text{ Min}$
V_{OH}	Output High Voltage	$V_{DD}-0.2$		V	$I_{OH}=-100 \mu\text{A}$, $V_{DD}=V_{DD} \text{ Min}$

T13.8 25041

1. Typical conditions for the Active Current shown on the front page of the data sheet are average values at 25°C (room temperature), and $V_{DD} = 3V$. Not 100% tested.
2. See Figure 20
3. The I_{DD} current listed is typically less than 2mA/MHz, with OE# at V_{IH} . Typical V_{DD} is 3V.



8 Mbit (x16) Multi-Purpose Flash Plus

SST39VF801C / SST39VF802C / SST39LF801C / SST39LF802C

Table 14: Recommended System Power-up Timings

Symbol	Parameter	Minimum	Units
$T_{PU-READ}^1$	Power-up to Read Operation	100	μ s
$T_{PU-WRITE}^1$	Power-up to Program/Erase Operation	100	μ s

T14.0 25041

1. This parameter is measured only for initial qualification and after a design or process change that could affect this parameter.

Table 15: Capacitance ($T_A = 25^\circ\text{C}$, $f=1$ Mhz, other pins open)

Parameter	Description	Test Condition	Maximum
$C_{I/O}^1$	I/O Pin Capacitance	$V_{I/O} = 0V$	12 pF
C_{IN}^1	Input Capacitance	$V_{IN} = 0V$	6 pF

T15.0 25041

1. This parameter is measured only for initial qualification and after a design or process change that could affect this parameter.

Table 16: Reliability Characteristics

Symbol	Parameter	Minimum Specification	Units	Test Method
$N_{END}^{1,2}$	Endurance	10,000	Cycles	JEDEC Standard A117
T_{DR}^1	Data Retention	100	Years	JEDEC Standard A103
I_{LTH}^1	Latch Up	$100 + I_{DD}$	mA	JEDEC Standard 78

T16.2 25041

1. This parameter is measured only for initial qualification and after a design or process change that could affect this parameter.
2. N_{END} endurance rating is qualified as a 10,000 cycle minimum for the whole device. A sector- or block-level rating would result in a higher minimum specification.



AC Characteristics

Table 17: Read Cycle Timing Parameters $V_{DD} = 2.7-3.6V$

Symbol	Parameter	SST39VF801C/802C		SST39LF801C/802C		Units
		Min	Max	Min	Max	
T_{RC}	Read Cycle Time	70		55		ns
T_{CE}	Chip Enable Access Time		70		55	ns
T_{AA}	Address Access Time		70		55	ns
T_{OE}	Output Enable Access Time		35		30	ns
T_{CLZ}^1	CE# Low to Active Output	0		0		ns
T_{OLZ}^1	OE# Low to Active Output	0		0		ns
T_{CHZ}^1	CE# High to High-Z Output		20		15	ns
T_{OHZ}^1	OE# High to High-Z Output		20		15	ns
T_{OH}^1	Output Hold from Address Change	0		0		ns
T_{RP}^1	RST# Pulse Width	500		500		ns
T_{RHR}^1	RST# High before Read	50		50		ns
$T_{RY}^{1,2}$	RST# Pin Low to Read Mode		20		20	μs

T17.3 25041

1. This parameter is measured only for initial qualification and after a design or process change that could affect this parameter.
2. This parameter applies to Sector-Erase, Block-Erase and Program operations.
This parameter does not apply to Chip-Erase operations.

Table 18: Program/Erase Cycle Timing Parameters

Symbol	Parameter	Min	Max	Units
T_{BP}	Word-Program Time		10	μs
T_{AS}	Address Setup Time	0		ns
T_{AH}	Address Hold Time	30		ns
T_{CS}	WE# and CE# Setup Time	0		ns
T_{CH}	WE# and CE# Hold Time	0		ns
T_{OES}	OE# High Setup Time	0		ns
T_{OEH}	OE# High Hold Time	10		ns
T_{CP}	CE# Pulse Width	40		ns
T_{WP}	WE# Pulse Width	40		ns
T_{WPH}^1	WE# Pulse Width High	30		ns
T_{CPH}^1	CE# Pulse Width High	30		ns
T_{DS}	Data Setup Time	30		ns
T_{DH}^1	Data Hold Time	0		ns
T_{IDA}^1	Software ID Access and Exit Time		150	ns
T_{SE}	Sector-Erase		25	ms
T_{BE}	Block-Erase		25	ms
T_{SCE}	Chip-Erase		50	ms
$T_{BY}^{1,2}$	RY/BY# Delay Time		90	ns
T_{BR}^1	Bus Recovery Time		0	μs

T18.1 25041

1. This parameter is measured only for initial qualification and after a design or process change that could affect this parameter.
2. This parameter applies to Sector-Erase, Block-Erase, and Program operations.



8 Mbit (x16) Multi-Purpose Flash Plus

SST39VF801C / SST39VF802C / SST39LF801C / SST39LF802C

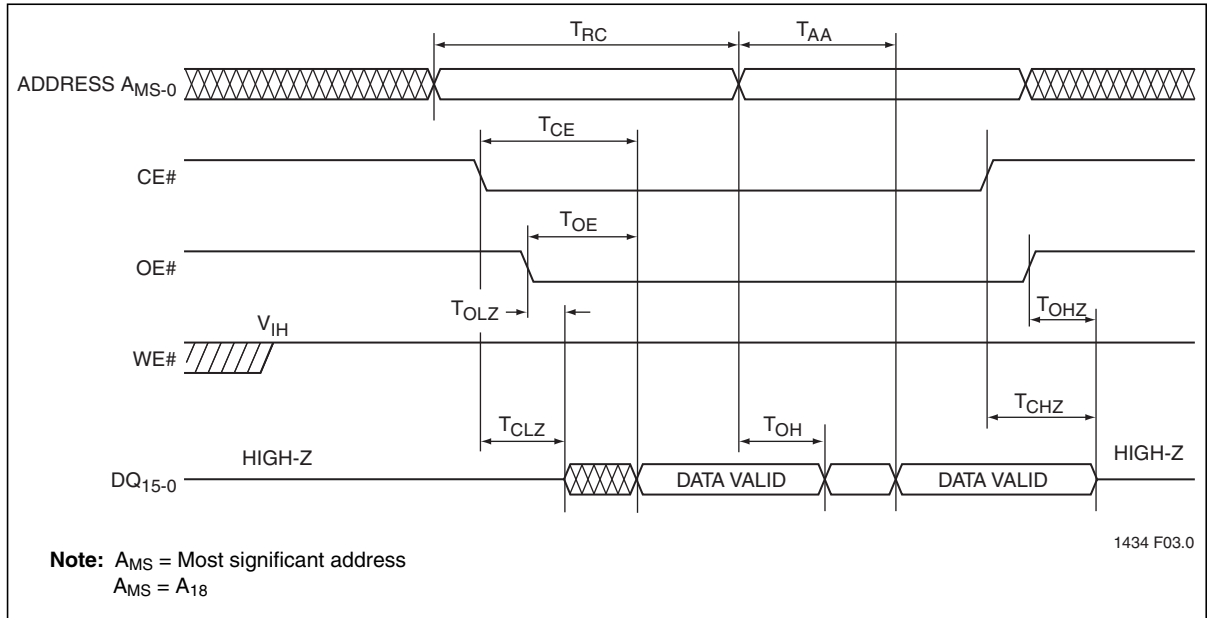

Figure 6: Read Cycle Timing Diagram

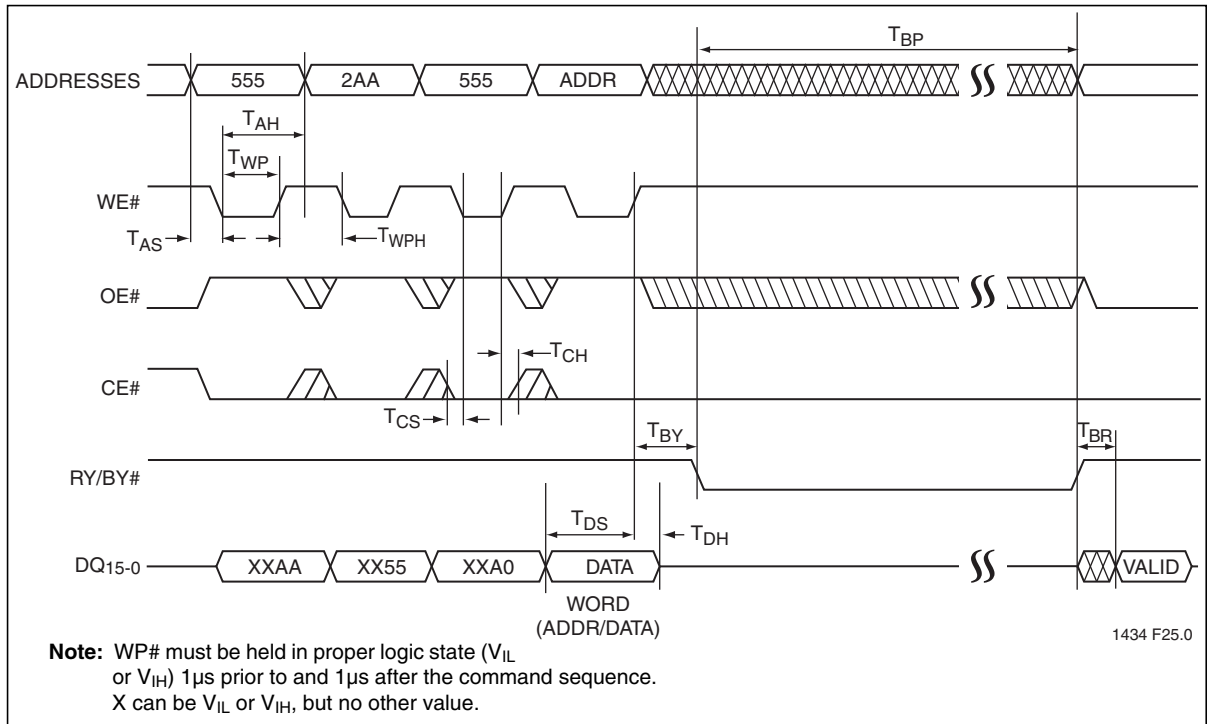

Figure 7: WE# Controlled Program Cycle Timing Diagram

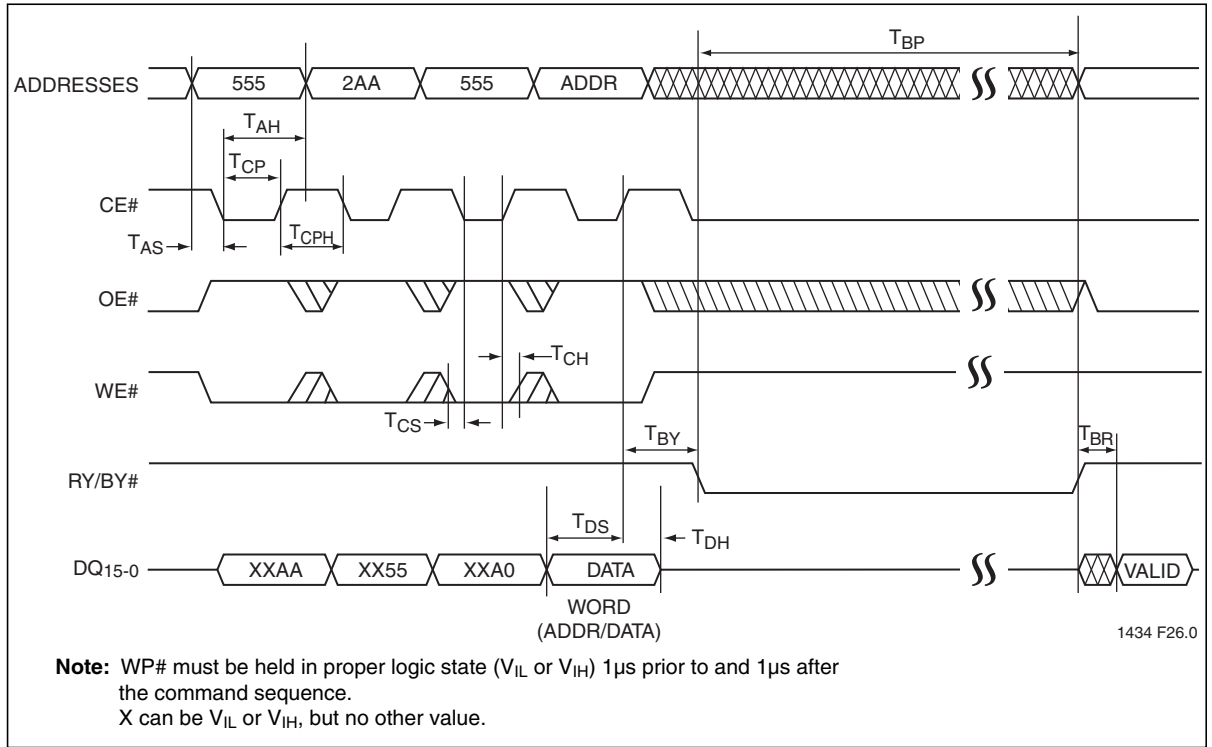

Figure 8: CE# Controlled Program Cycle Timing Diagram

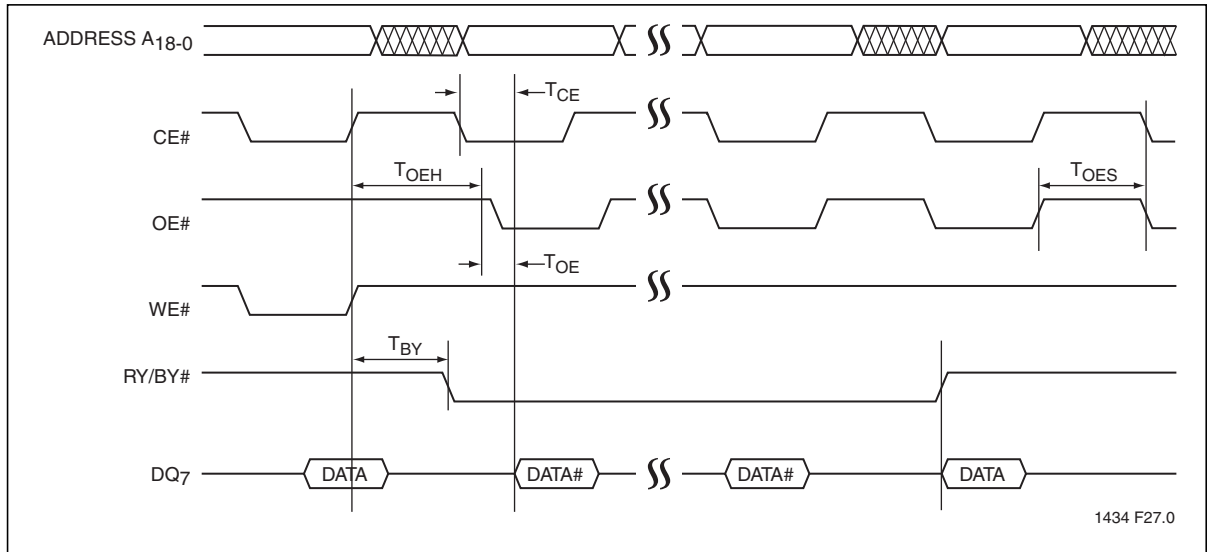

Figure 9: Data# Polling Timing Diagram

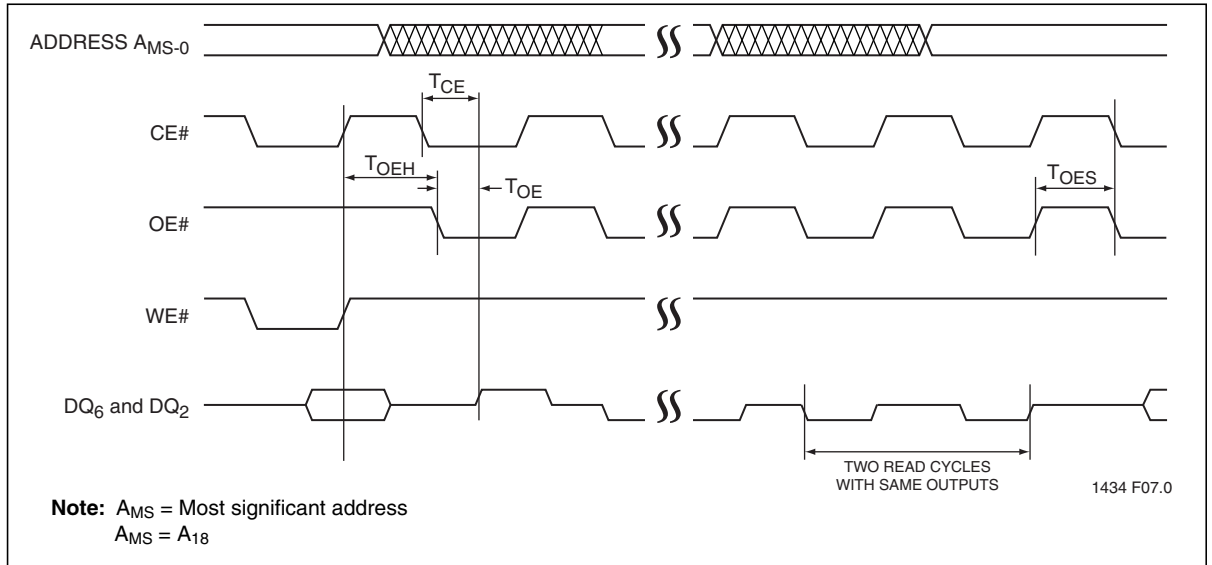

Figure 10: Toggle Bits Timing Diagram

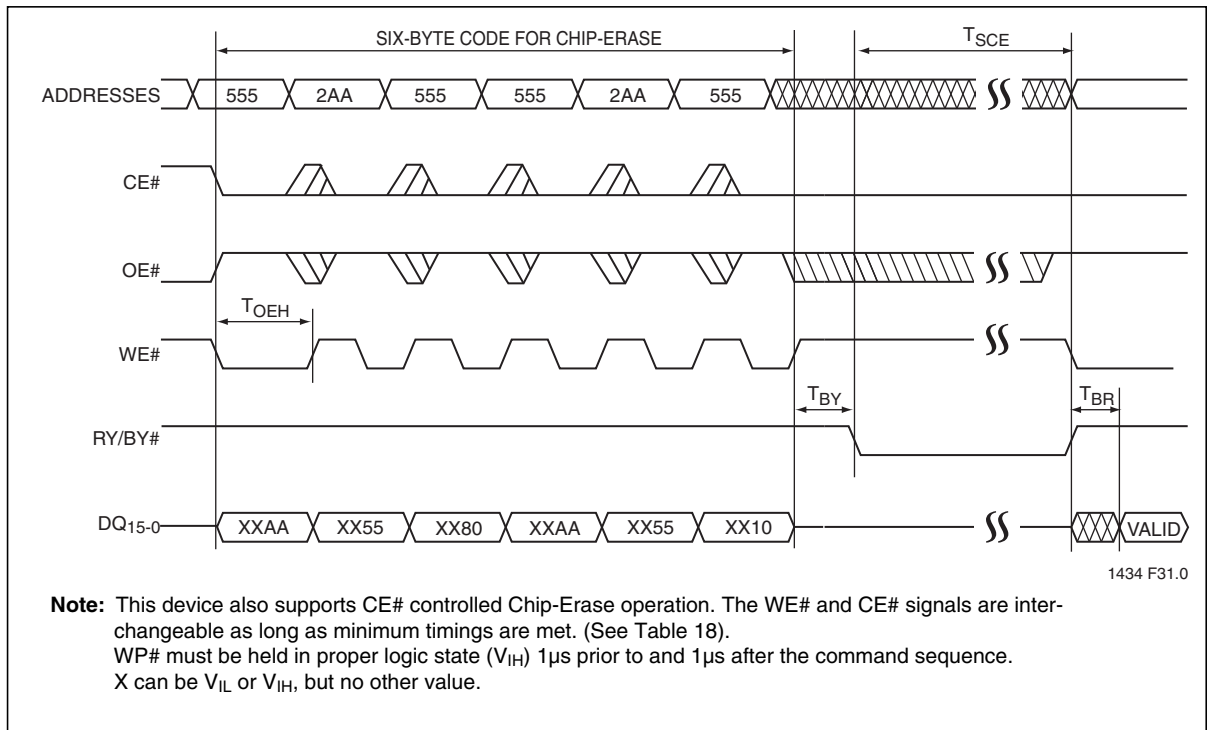

Figure 11: WE# Controlled Chip-Erase Timing Diagram



8 Mbit (x16) Multi-Purpose Flash Plus

SST39VF801C / SST39VF802C / SST39LF801C / SST39LF802C

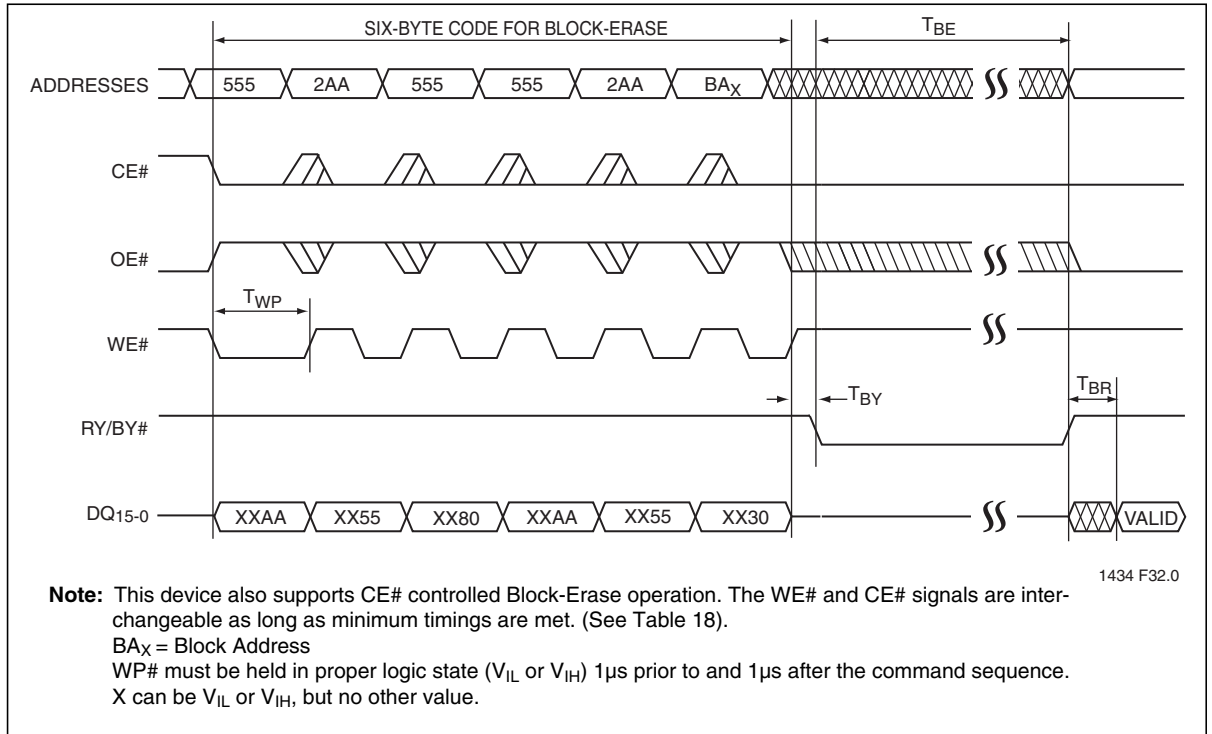

Figure 12:WE# Controlled Block-Erase Timing Diagram

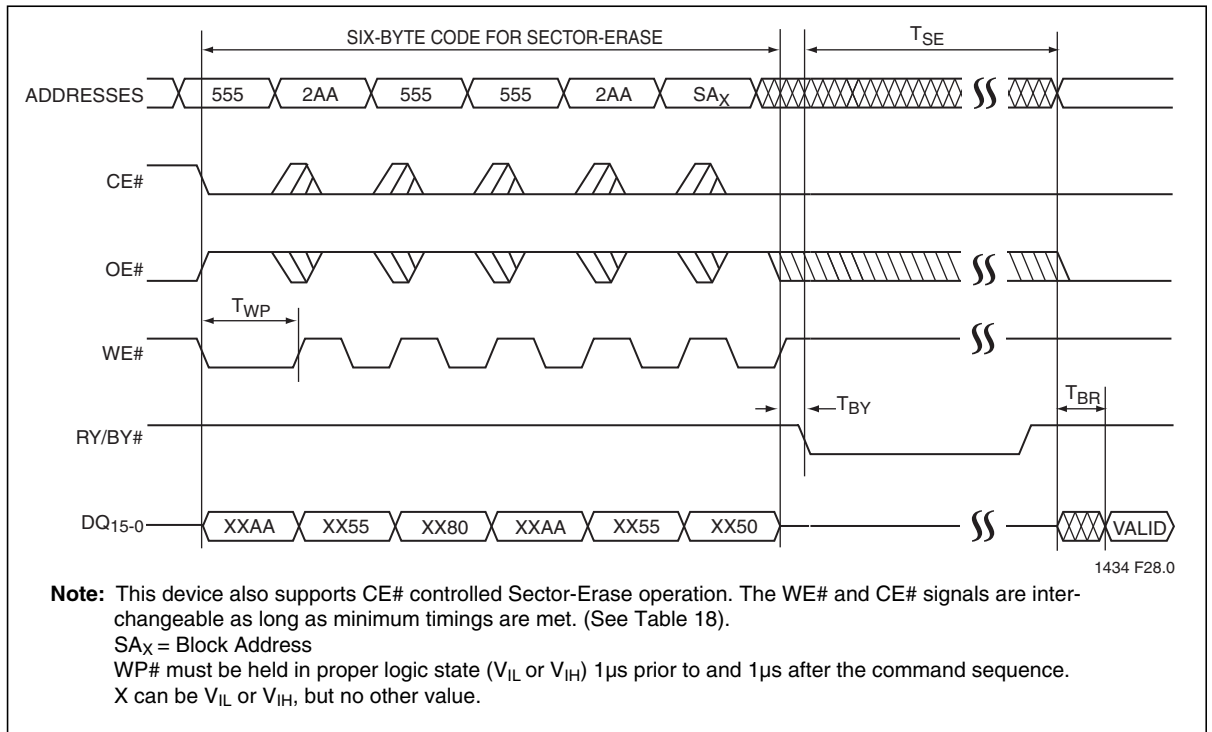

Figure 13:WE# Controlled Sector-Erase Timing Diagram

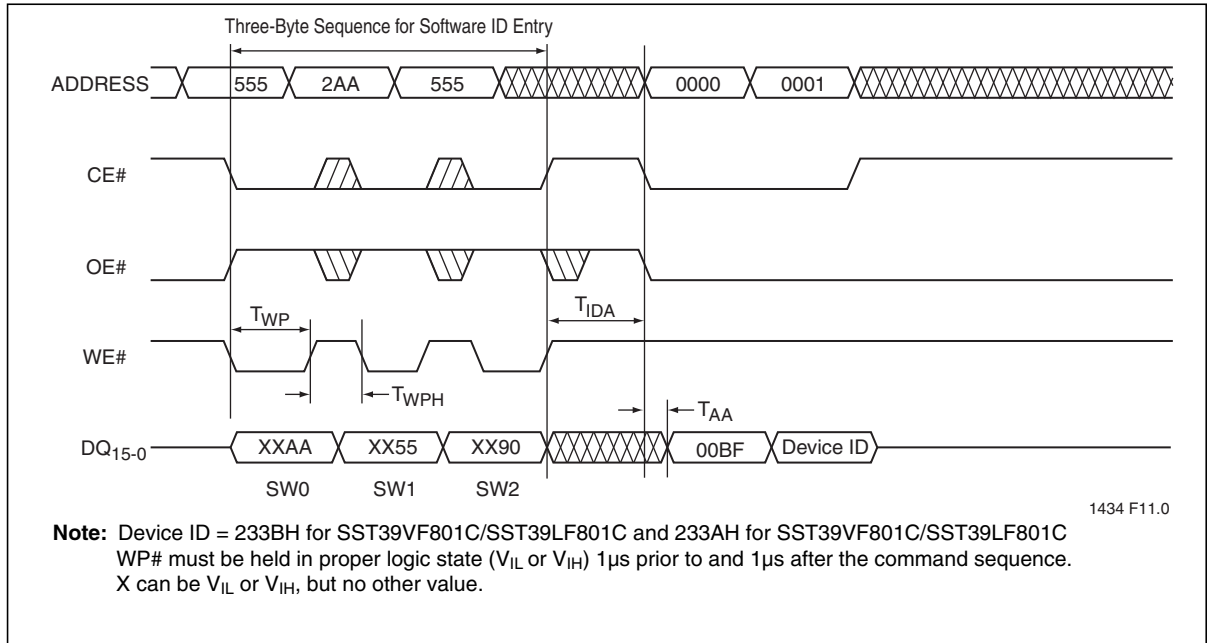

Figure 14: Software ID Entry and Read

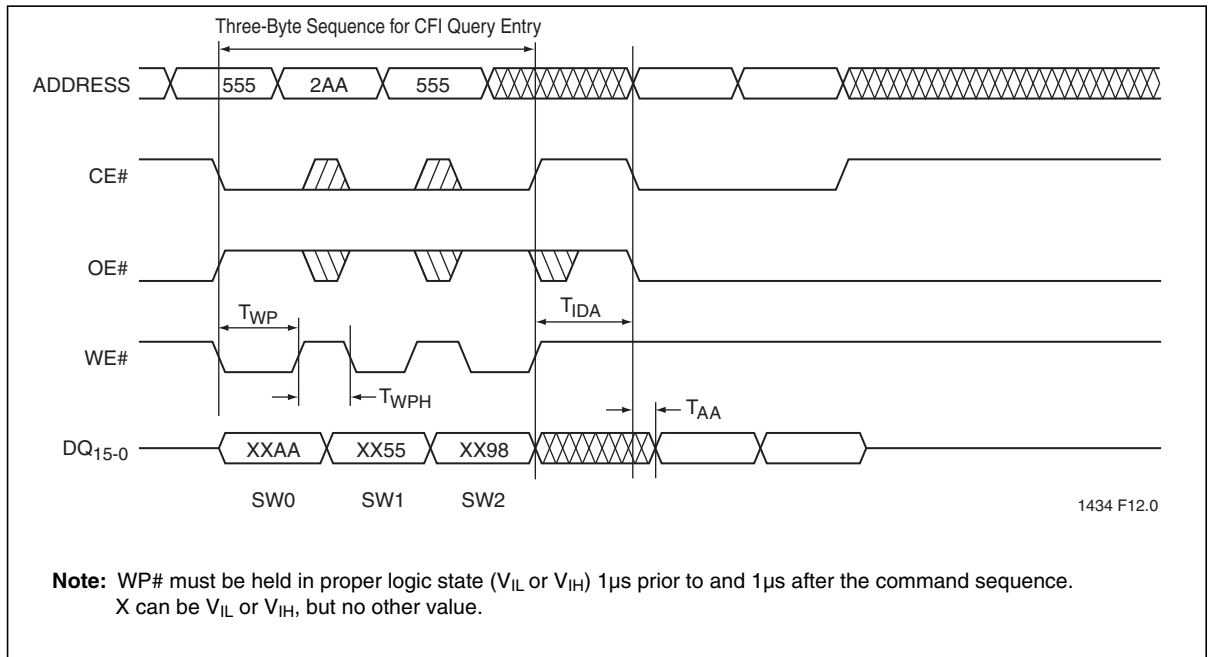

Figure 15: CFI Query Entry and Read

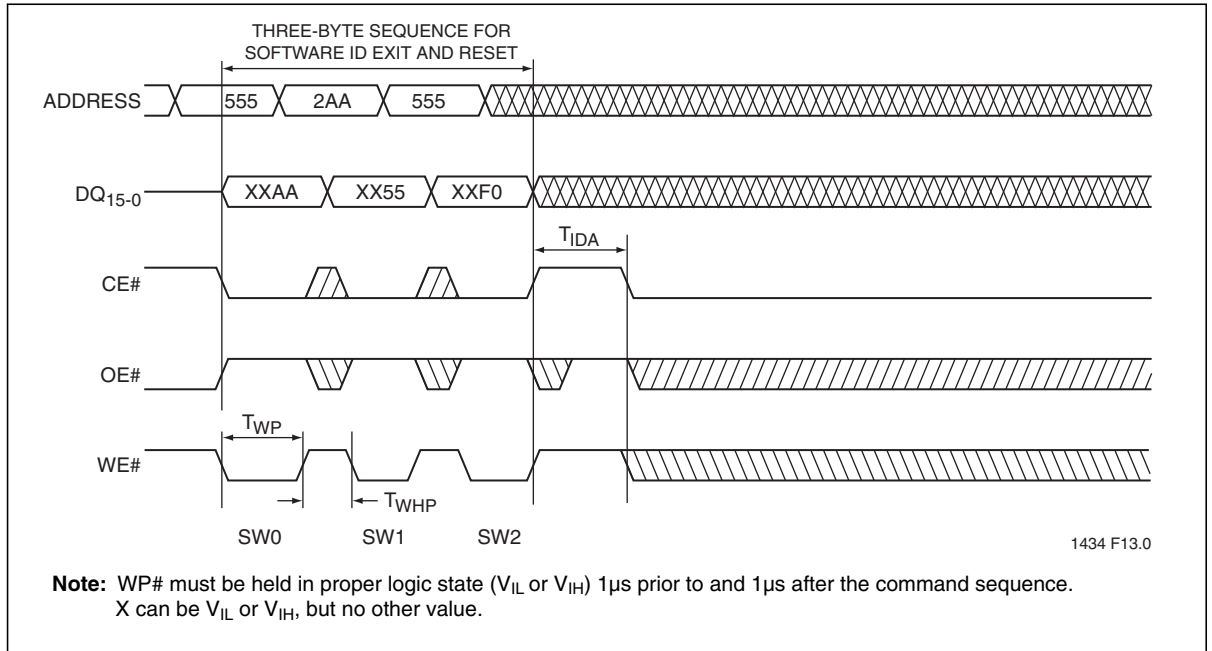

Figure 16: Software ID Exit/CFI Exit

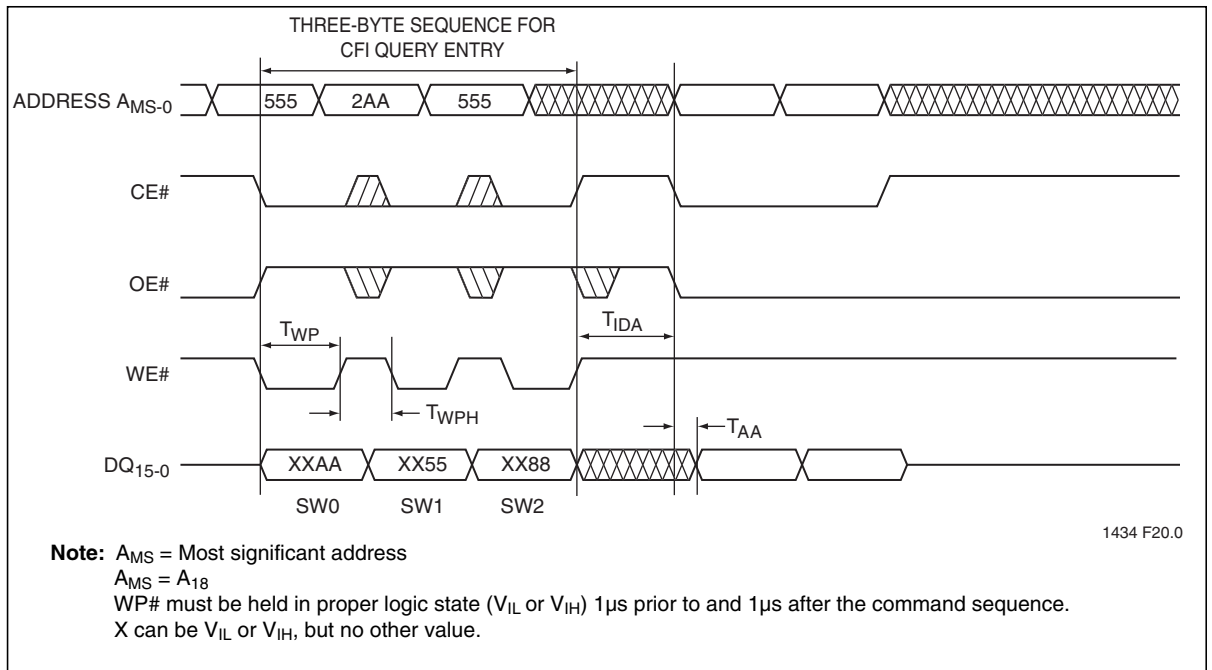

Figure 17: Sec ID Entry

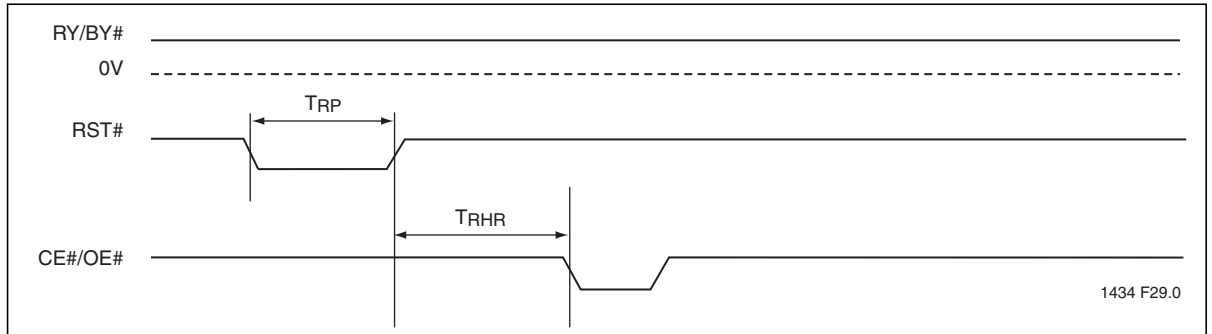

Figure 18:RST# Timing Diagram (When no internal operation is in progress)

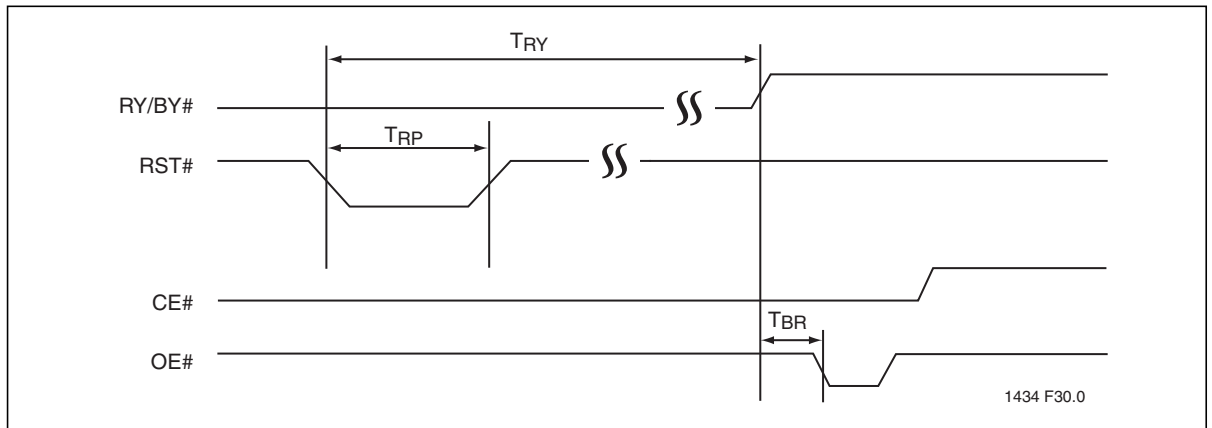

Figure 19:RST# Timing Diagram (During Program or Erase operation)

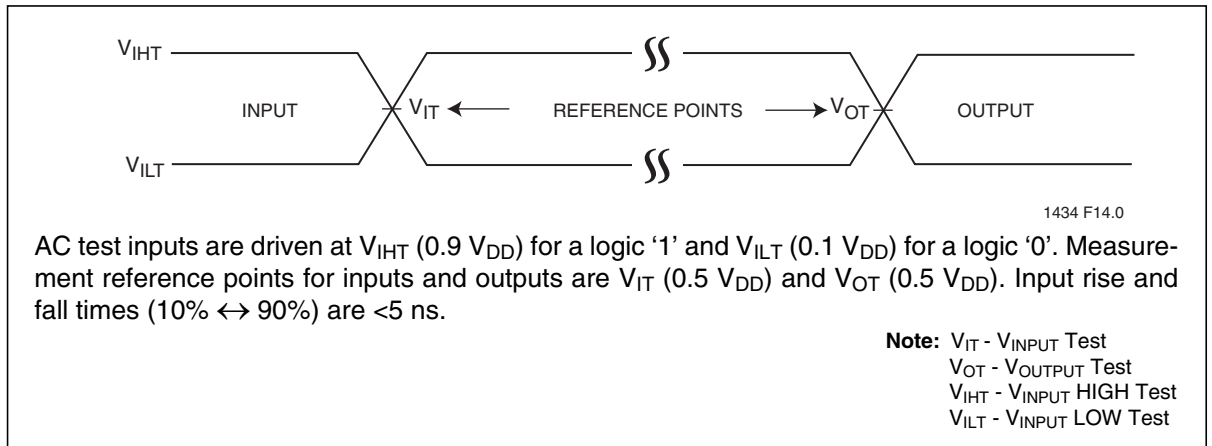

Figure 20:AC Input/Output Reference Waveforms



A Microchip Technology Company

8 Mbit (x16) Multi-Purpose Flash Plus

SST39VF801C / SST39VF802C / SST39LF801C / SST39LF802C

Data Sheet

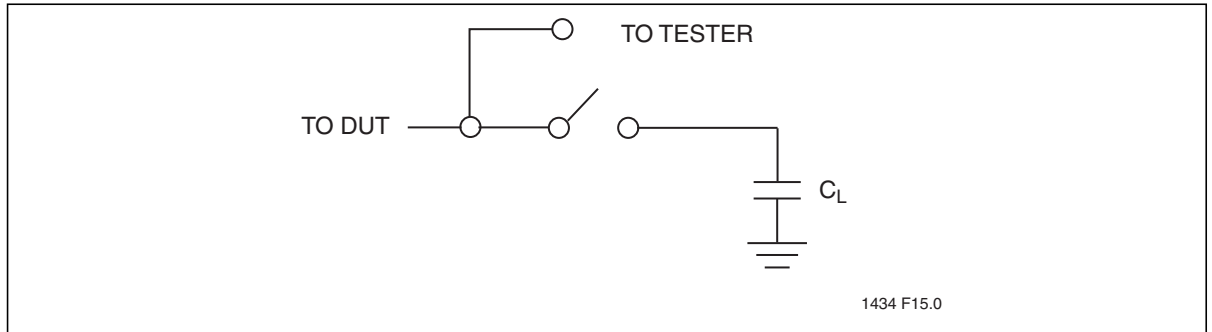

Figure 21:A Test Load Example

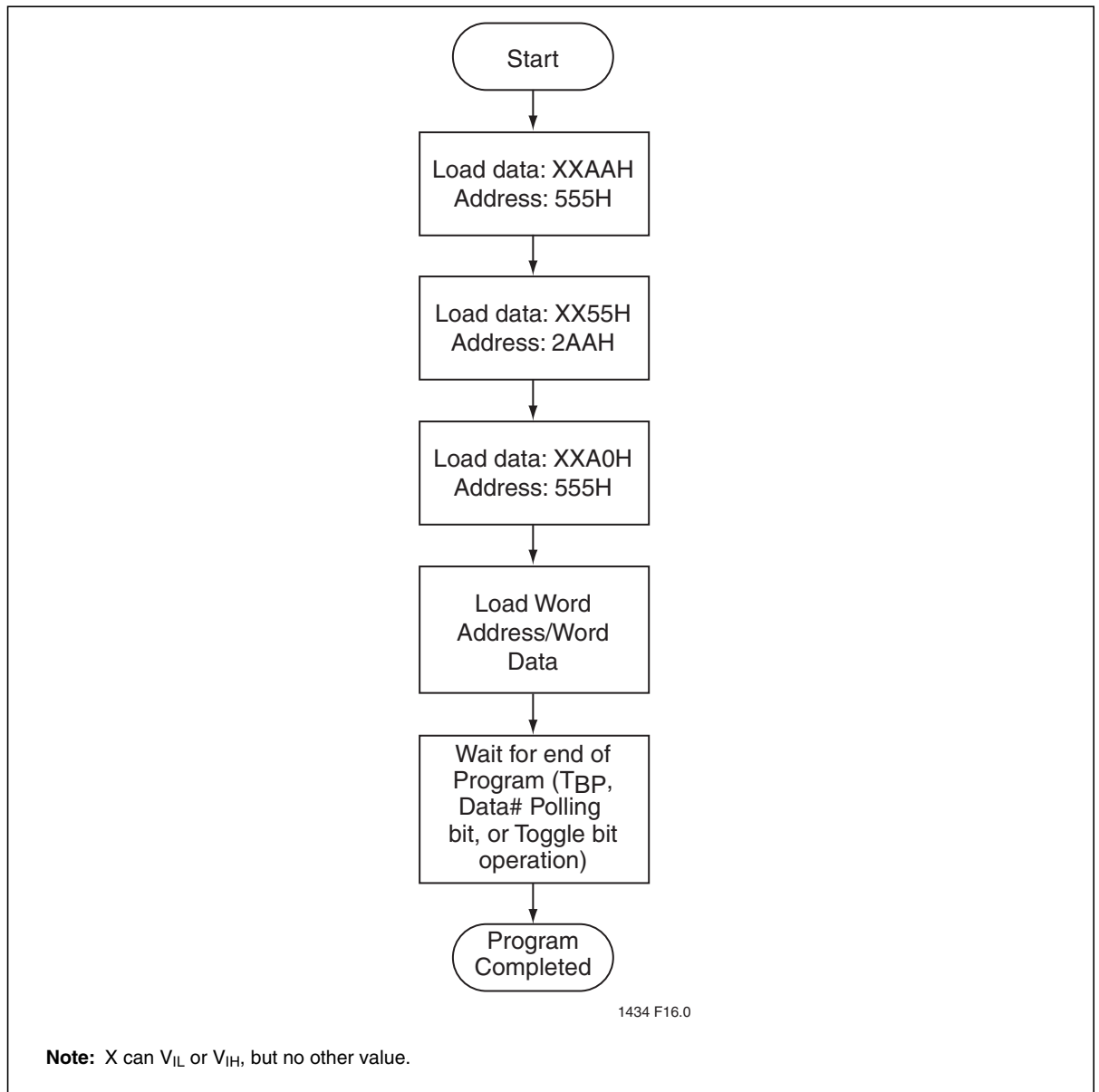

Figure 22: Word-Program Algorithm



8 Mbit (x16) Multi-Purpose Flash Plus

SST39VF801C / SST39VF802C / SST39LF801C / SST39LF802C

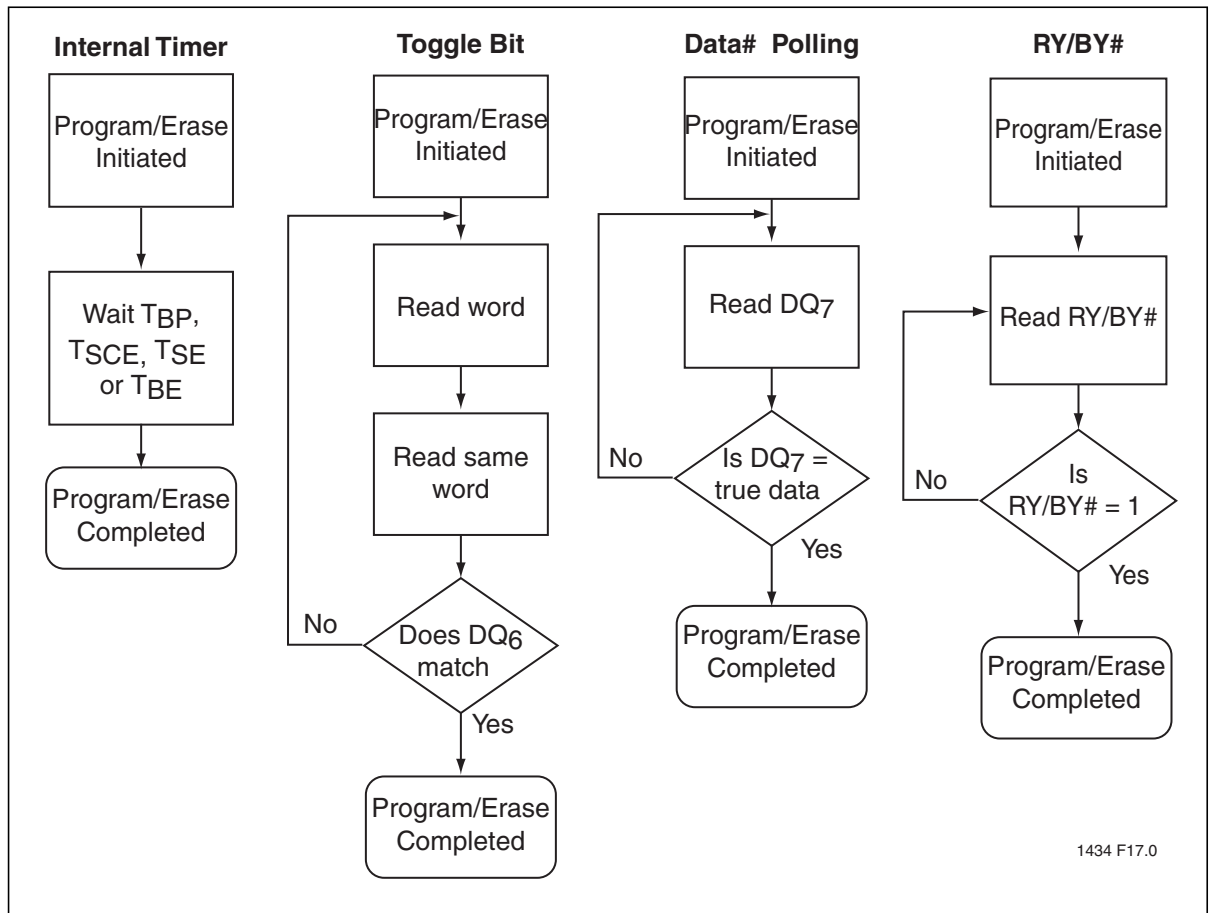

Figure 23: Wait Options

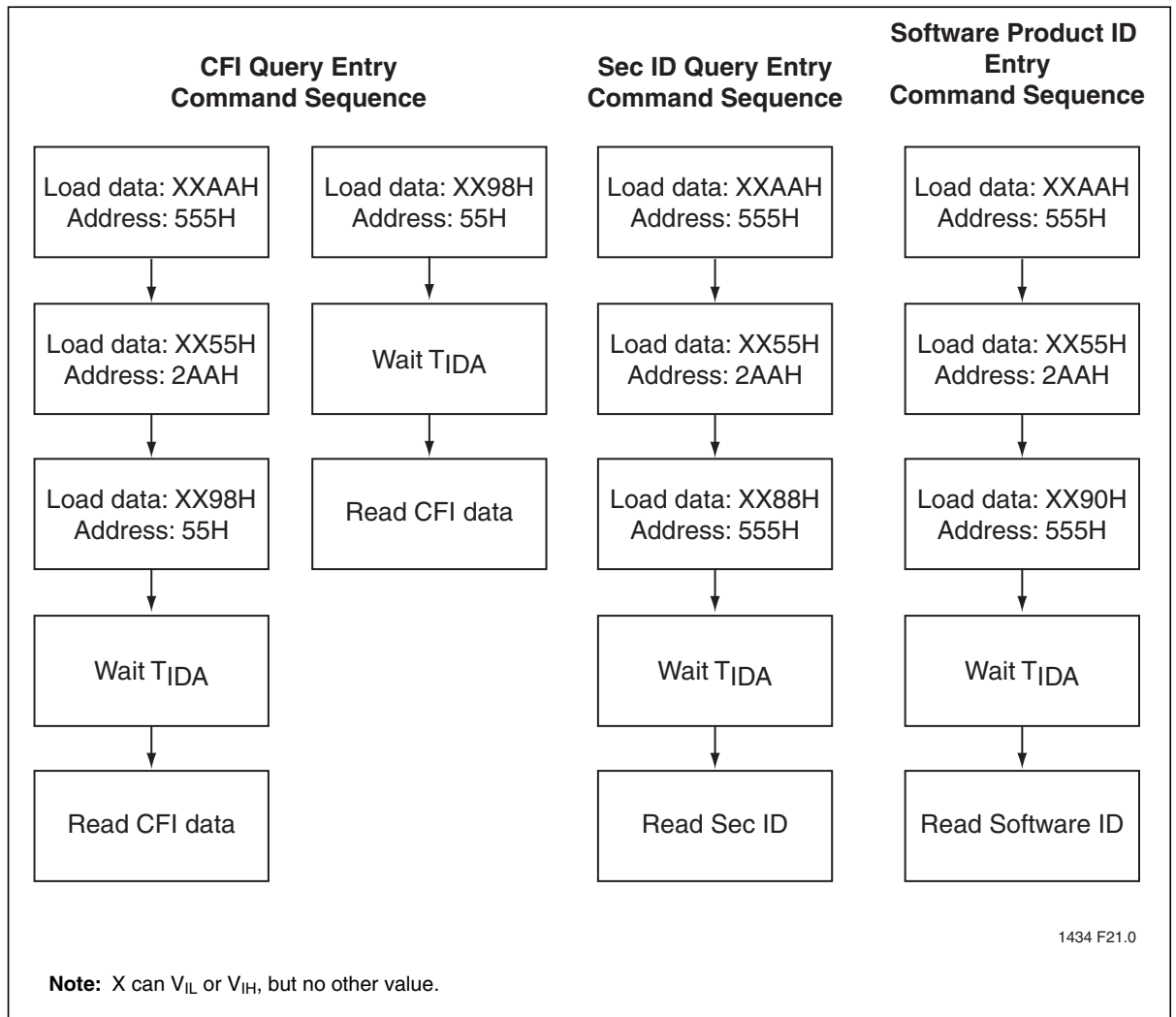

Figure 24: Software ID/CFI Entry Command Flowcharts

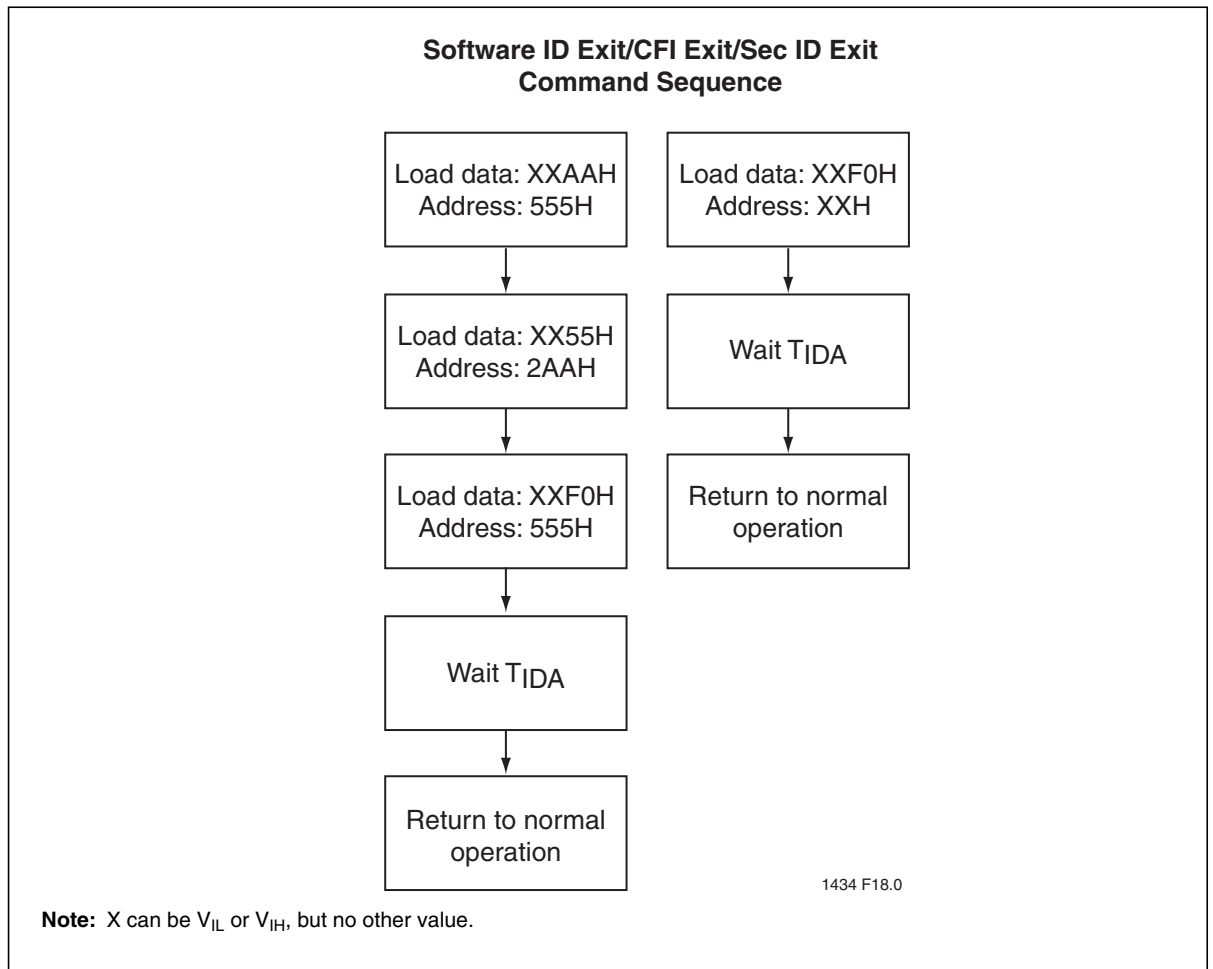

Figure 25: Software ID/CFI Exit Command Flowcharts

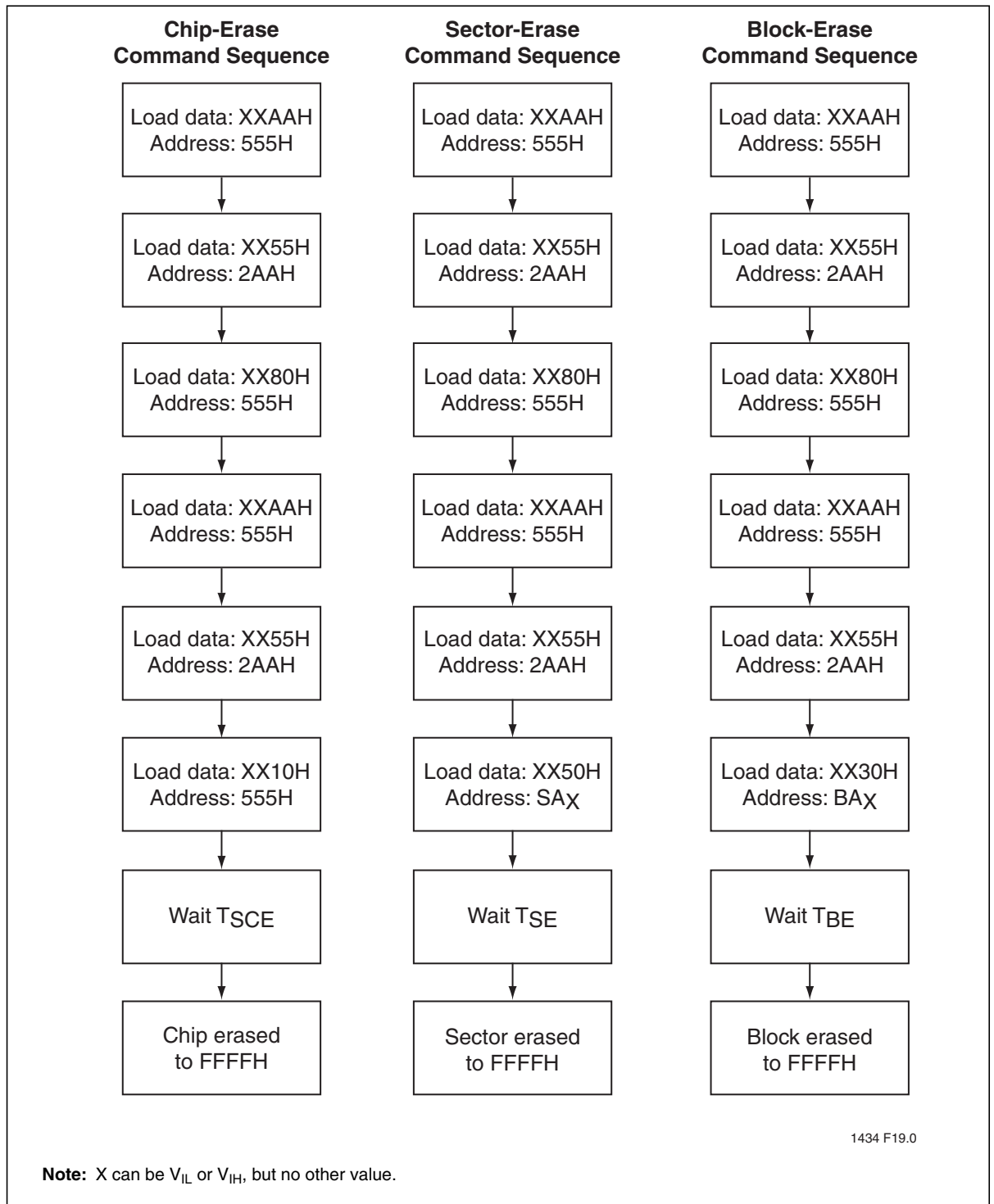

Figure 26: Erase Command Sequence



A Microchip Technology Company

8 Mbit (x16) Multi-Purpose Flash Plus

SST39VF801C / SST39VF802C / SST39LF801C / SST39LF802C

Data Sheet

Valid Combinations for SST39VF801C

SST39VF801C-70-4C-EKE	SST39VF801C-70-4C-B3KE	SST39VF801C-70-4C-MAQE
SST39VF801C-70-4I-EKE	SST39VF801C-70-4I-B3KE	SST39VF801C-70-4I-MAQE

Valid Combinations for SST39VF802C

SST39VF802C-70-4C-EKE	SST39VF802C-70-4C-B3KE	SST39VF802C-70-4C-MAQE
SST39VF802C-70-4I-EKE	SST39VF802C-70-4I-B3KE	SST39VF802C-70-4I-MAQE

Valid Combinations for SST39LF801C

SST39LF801C-55-4C-EKE	SST39LF801C-55-4C-B3KE	SST39LF801C-55-4C-MAQE
-----------------------	------------------------	------------------------

Valid Combinations for SST39LF802C

SST39LF802C-55-4C-EKE	SST39LF802C-55-4C-B3KE	SST39LF802C-55-4C-MAQE
-----------------------	------------------------	------------------------

Note: Valid combinations are those products in mass production or will be in mass production. Consult your SST sales representative to confirm availability of valid combinations and to determine availability of new combinations.



Packaging Diagrams

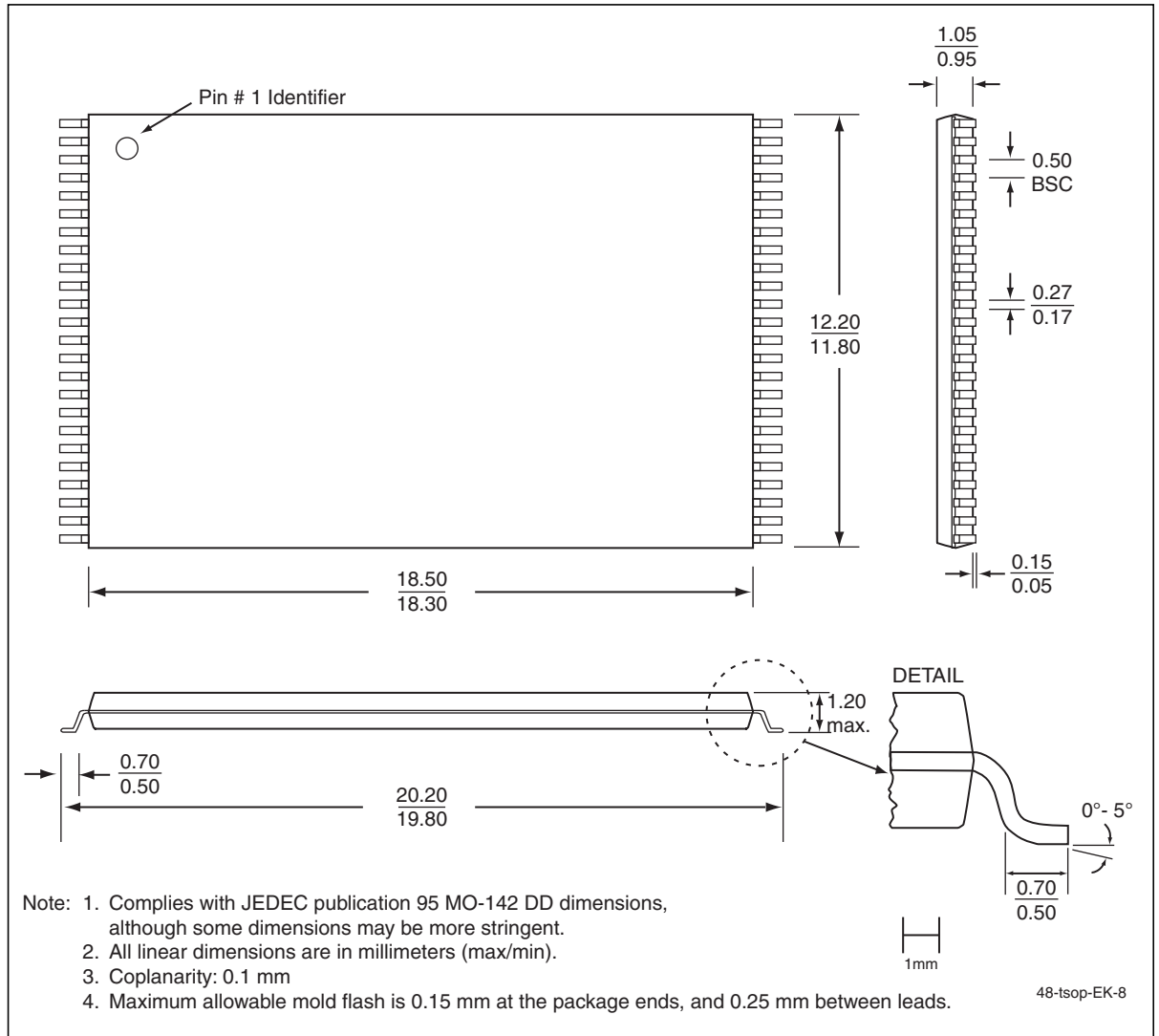

Figure 27:48-lead Thin Small Outline Package (TSOP) 12mm x 20mm
SST Package Code: EK



8 Mbit (x16) Multi-Purpose Flash Plus

SST39VF801C / SST39VF802C / SST39LF801C / SST39LF802C

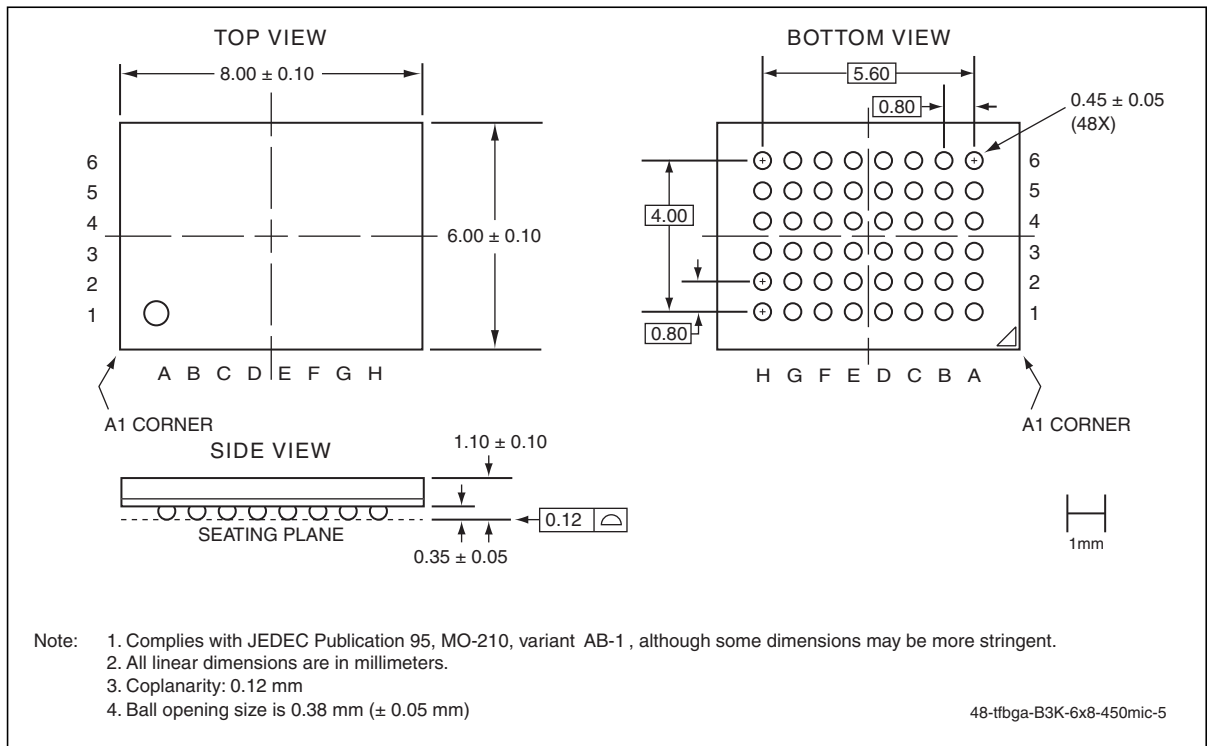

Figure 28: 48-ball Thin-profile, Fine-pitch Ball Grid Array (TFBGA) 6mm x 8mm
 SST Package Code: B3K



8 Mbit (x16) Multi-Purpose Flash Plus SST39VF801C / SST39VF802C / SST39LF801C / SST39LF802C

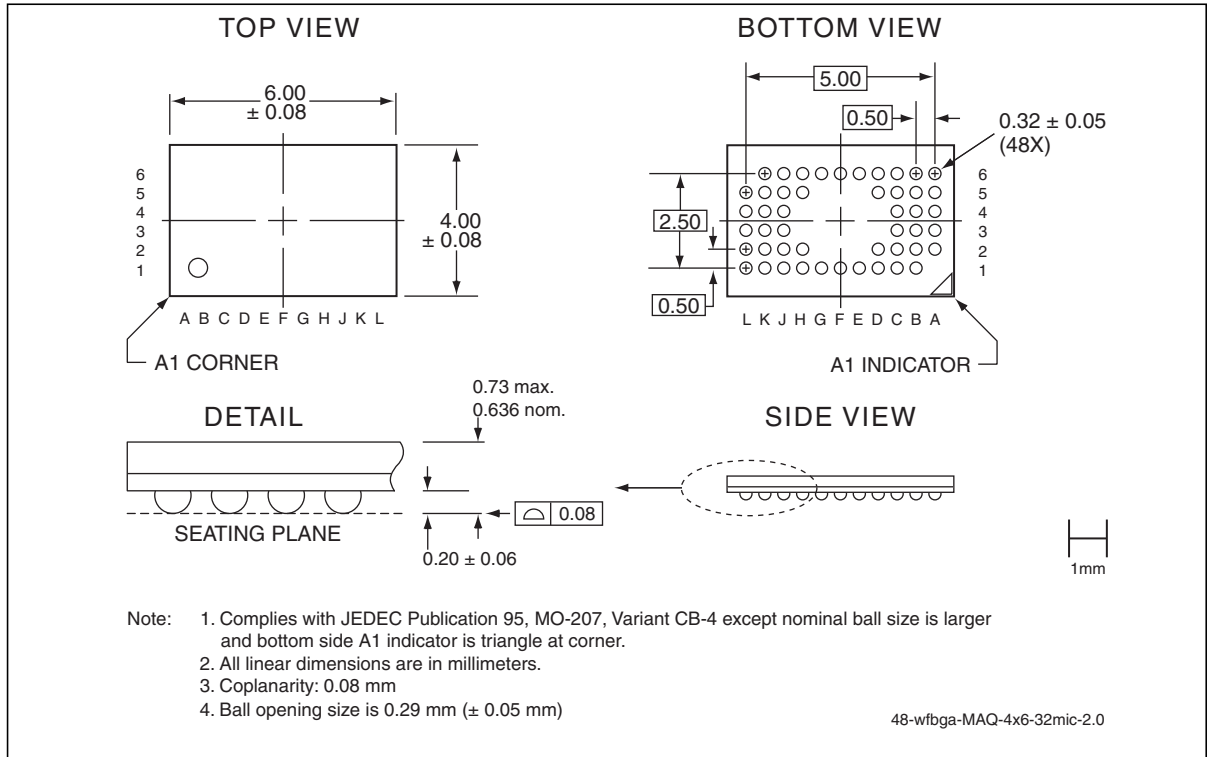

Figure 29:48-ball Very, Very Thin-profile, Fine-pitch Ball Grid Array (WFBGA) 4mm x 6mm
SST Package Code: MAQ



A Microchip Technology Company

8 Mbit (x16) Multi-Purpose Flash Plus

SST39VF801C / SST39VF802C / SST39LF801C / SST39LF802C

Data Sheet

Table 19: Revision History

Number	Description	Date
A	• Initial release	May 2011

ISBN: 978-1-61341-197-1

© 2011 Silicon Storage Technology, Inc—a Microchip Technology Company. All rights reserved.

SST, Silicon Storage Technology, the SST logo, SuperFlash, MTP, and FlashFlex are registered trademarks of Silicon Storage Technology, Inc. MPF, SQI, Serial Quad I/O, and Z-Scale are trademarks of Silicon Storage Technology, Inc. All other trademarks and registered trademarks mentioned herein are the property of their respective owners.

Specifications are subject to change without notice. Refer to www.microchip.com for the most recent documentation. For the most current package drawings, please see the Packaging Specification located at <http://www.microchip.com/packaging>.

Memory sizes denote raw storage capacity; actual usable capacity may be less.

SST makes no warranty for the use of its products other than those expressly contained in the Standard Terms and Conditions of Sale.

For sales office(s) location and information, please see www.microchip.com.

Silicon Storage Technology, Inc.
A Microchip Technology Company
www.microchip.com

Данный компонент на территории Российской Федерации

Вы можете приобрести в компании MosChip.

Для оперативного оформления запроса Вам необходимо перейти по данной ссылке:

<http://moschip.ru/get-element>

Вы можете разместить у нас заказ для любого Вашего проекта, будь то серийное производство или разработка единичного прибора.

В нашем ассортименте представлены ведущие мировые производители активных и пассивных электронных компонентов.

Нашей специализацией является поставка электронной компонентной базы двойного назначения, продукции таких производителей как XILINX, Intel (ex.ALTERA), Vicor, Microchip, Texas Instruments, Analog Devices, Mini-Circuits, Amphenol, Glenair.

Сотрудничество с глобальными дистрибьюторами электронных компонентов, предоставляет возможность заказывать и получать с международных складов практически любой перечень компонентов в оптимальные для Вас сроки.

На всех этапах разработки и производства наши партнеры могут получить квалифицированную поддержку опытных инженеров.

Система менеджмента качества компании отвечает требованиям в соответствии с ГОСТ Р ИСО 9001, ГОСТ РВ 0015-002 и ЭС РД 009

Офис по работе с юридическими лицами:

105318, г.Москва, ул.Щербаковская д.3, офис 1107, 1118, ДЦ «Щербаковский»

Телефон: +7 495 668-12-70 (многоканальный)

Факс: +7 495 668-12-70 (доб.304)

E-mail: info@moschip.ru

Skype отдела продаж:

moschip.ru

moschip.ru_4

moschip.ru_6

moschip.ru_9