

Color Mark Sensors

E3S-DC/E3NX-CA Series

Color Mark Detection on Any Type of Packaging

Color Mark Photoelectric Sensor
E3S-DC

 IO-Link

Color Fiber Amplifier Unit
E3NX-CA

EtherCAT 

- Able to handle glossy materials
- Able to detect subtle color differences
- Stable even when lots change



Food/
Beverage/
Personal Care
Industries

Packaging Comes in a Variety of Designs and Materials

Recently, packaging materials and designs have grown much more diverse, such as aluminum vapor deposition material to prevent oxidation, or very colorful packages to attract the attention of consumers.



Highly-reflective glossy packaging, such as aluminum vapor deposition material



Colorful packaging where there is little difference in color between the mark and background



Low-reflection packaging, such as film with fine asperities



Business Challenge

If we respond to packaging trends, the number of false detection with color mark sensors will increase, reducing productivity...

More and more people working with color mark detection in the field are calling for the following:

"I want stable detection of aluminum vapor deposition material and other glossy packaging."

"I want stable detection of colorful packaging with little color difference."

"I want stable detection of packaging even if the lot changes."



NEW

Color Mark Photoelectric Sensor
E3S-DC

 **IO-Link**



OMRON's New Color Mark Sensors

Offer Stable Detection of Both Glossy and Colorful Packaging.

It therefore does not reduce the operation rates of production facilities.

The Sensors can accurately detect color marks on glossy and colorful packaging, which have been troublesome for conventional systems.

They also help reduce the number of troubleshooting requests made to packaging machine manufacturers—without any decrease in the operation rate due to equipment stoppages caused by false detection.

NEW

Color Fiber Amplifier Unit
E3NX-CA

EtherCAT 





“I want stable detection of aluminum vapor deposition material and other glossy packaging.”

Existing challenges

The intensity of the light received by the sensor from highly-reflective glossy packaging is too strong, so there is not enough difference in incident levels to perform color mark detection (i.e. saturation, Fig. 1).

The angle needs to be finely adjusted to avoid saturation and allow the sensor to detect the mark. However, if the sensor is tilted too much, detection will become unstable as the incident level decreases (Fig. 2).

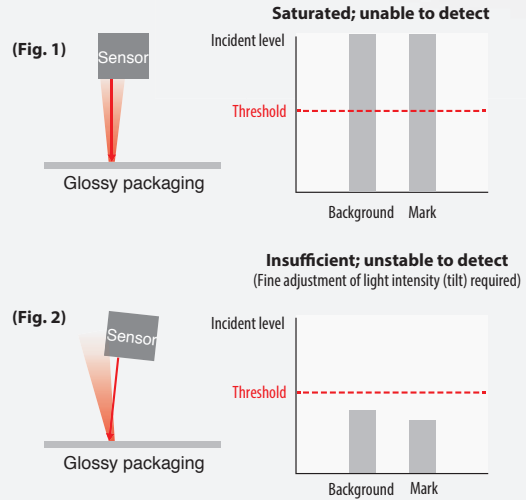
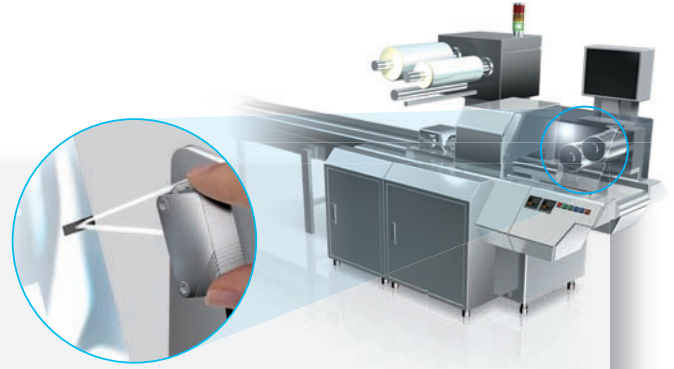

E3S-DC/E3NX-CA

Light Is Received over a Wide Range: Enough Even for Glossy Packaging

This allows for the stable detection of glossy aluminum vapor deposition packaging—simply install the Sensor directly above

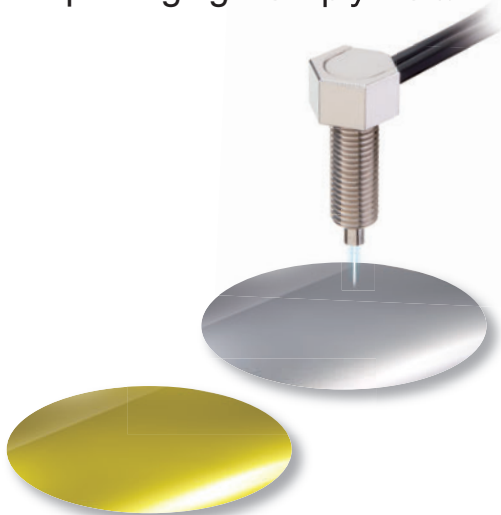

Follow along to see how the technology works.



No Saturation Even with 99% Reflective Optical Mirrors

High Dynamic Range (Wide Incident Light Range)

Color Mark Photoelectric Sensor (E3S-DC):

The incident light range in which no saturation occurs—no adjustment required

The included high luminance RGB three-color LED light emitting element drastically improves the light intensity. Meanwhile, Smart Noise Reduction technology in the Fiber Sensor is applied to reduce the amount of noise, resulting in a high dynamic range where the Sensor is not saturated even when detecting a mirror surface—without having to make any light intensity adjustments.

Color Fiber Amplifier Unit (E3NX-CA):

The optimal light intensity—with just two button presses

The high luminance white LED and Smart Noise Reduction technology work together to increase the light intensity and reduce the amount of noise. These have made it possible to expand the light intensity adjustment range for the emitter and receiver to 1/100x and 1/3x respectively, resulting in a high dynamic range four times that of conventional products. You can automatically adjust the optimal intensity by just pressing a button once with a mark and once without it.

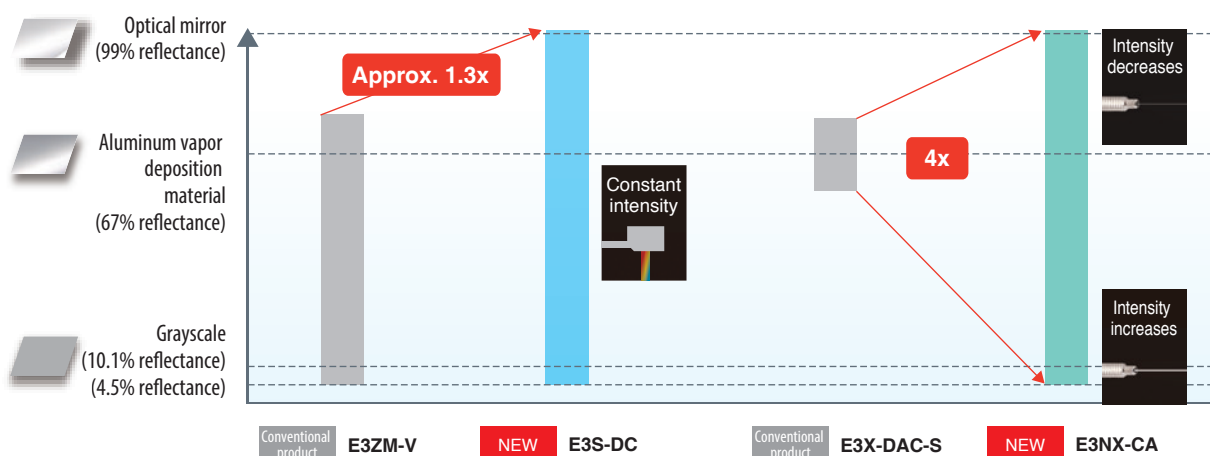

* Optical mirror and aluminum vapor deposition material measured at the distance with maximum incident level (13 mm); grayscale measured at the distance with minimum incident level (7 mm or 13 mm).

Further Information



Stable Detection Even of Tilted Workpieces

Thin and soft wrapping paper tends to be difficult to detect stably due to shifting angles. E3S-DC that has OMRON's original narrow beam and large optical system and E3NX-CA used with the coaxial Fiber Unit make stable detection possible.

Color Mark Photoelectric Sensor:

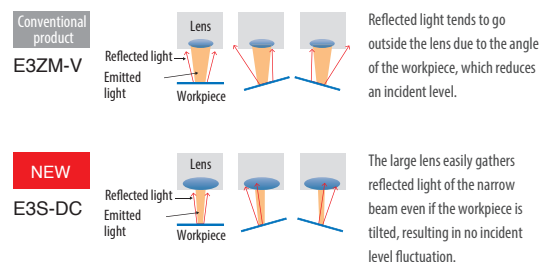

Color Fiber Amplifier Unit:

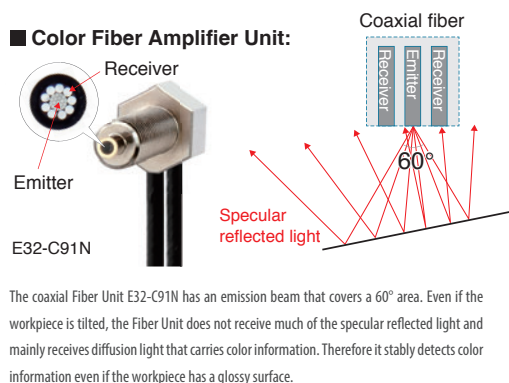



“I want stable detection of colorful packaging with little color difference.”

Existing challenges

With designs becoming more colorful, there are times where there is little difference in color between the color mark and the design elements (background). When color differences are subtle, the S/N ratio*1 required for detection cannot be obtained, and the color mark cannot be detected (Fig. 1).

*1 The ratio of incident levels at which a workpiece is and is not detected. For example, if this is 1,000 when detecting the workpiece and 100 when not detecting the workpiece, the S/N ratio is 10:1. The higher the S/N ratio is, the more stable the detection becomes.

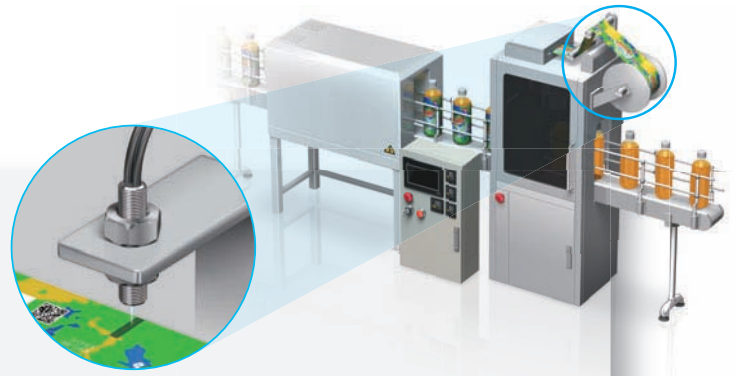

(Fig. 1)

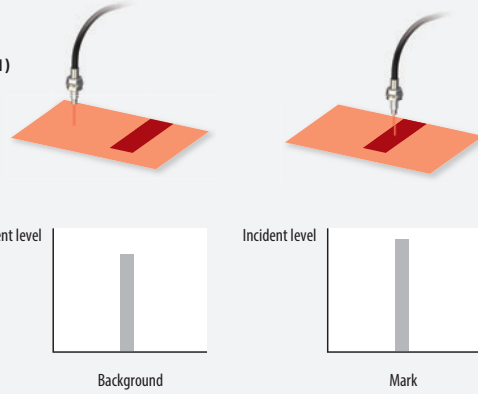

E3S-DC/E3NX-CA

Provides a High S/N Ratio to Detect Subtle Color Differences

Stable detection even of similar colors with only minor differences



Follow along to see how the technology works.



Identifies Even Minor Color Differences

High S/N Ratio System Design

Three N-Smart Technologies Work Together to Obtain a High S/N Ratio

The high luminance white LED of the Fiber Amplifier Unit, and the high luminance RGB three-color LEDs and high efficiency optical system design of the Photoelectric Sensor deliver high power. "Smart Noise Reduction" (a light reception algorithm) and "N-Core" (a high-speed, high-precision IC) work together to dramatically reduce the effect of noise. Increasing the incident level and decreasing noise make it possible to obtain a high S/N ratio even when color differences are subtle.

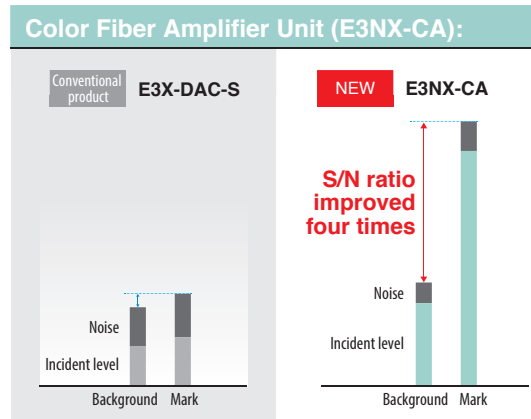
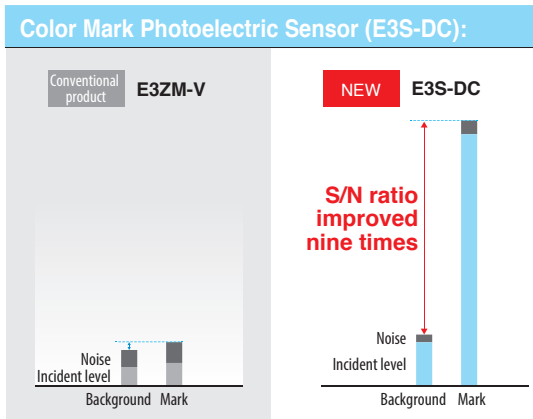
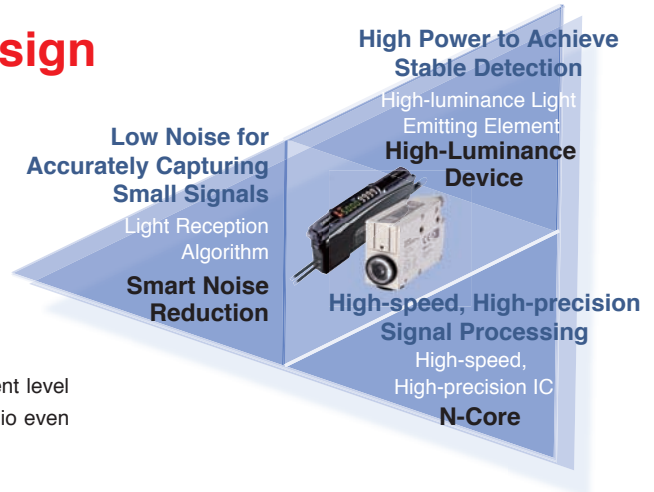

Further Information

From Single Wavelengths to Color Sensing

The wavelength ranges for red, green, and blue are narrow, and combinations with other colors cannot be detected with RGB single-color light source sensors (Fig. 2). For the new Color Mark Sensors, the Photoelectric Sensor uses RGB three-color LEDs as the light source, and the Fiber Sensor uses a white LED that has a broad wavelength range. Color sensing makes stable detection possible—even for those color combinations that would be difficult using single wavelengths.

(Fig. 2) Spectral Sensitivity Characteristics for Red, Green, Blue and White

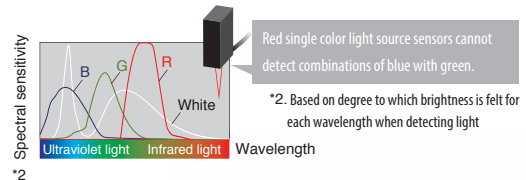

Color Mark Photoelectric Sensor (E3S-DC):

Three light sources (R, G, and B) in a single device

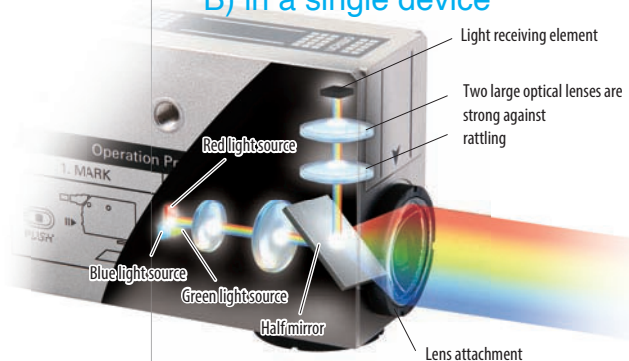

Color Fiber Amplifier Unit (E3NX-CA):

White LED light emitting element & RGB matrix light receiving element

High luminance white LED light emitting element

LEDs with narrow light emitting regions improve the efficiency of optical coupling with fiber.

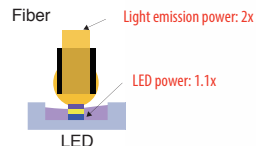

Patented Highly sensitive RGB matrix light receiving element

Detects all RGB wavelengths included in light reflected from the workpiece.

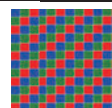



“I want stable detection of packaging even if the lot changes.”

Existing challenges

There are cases where colors of packaging materials vary from lot to lot. If the parameters are not changed, this could result in equipment stoppage caused by false detection. In such a case it can be difficult to determine the cause of the problem—resulting in time lost due to troubleshooting and a notable decrease in productivity.

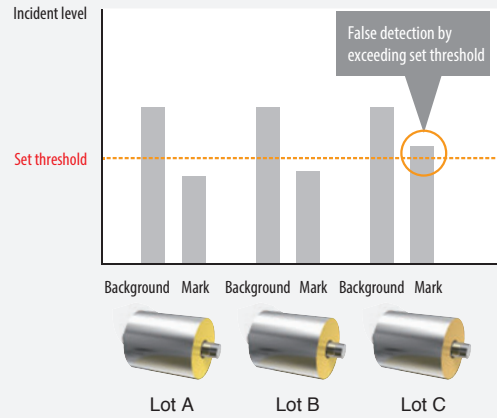
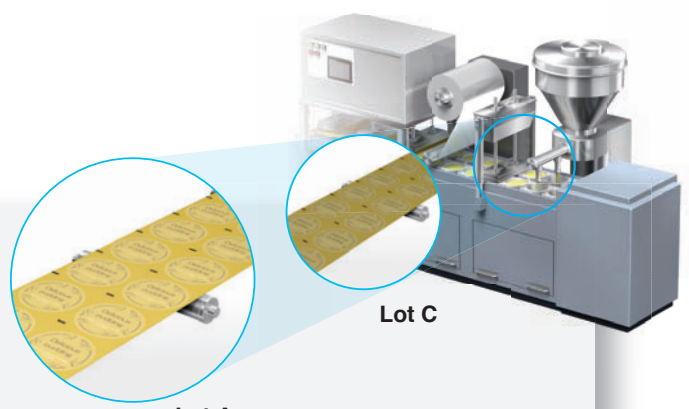

E3S-DC/E3NX-CA

Visualization of Variation in Colors Printed on Packaging Makes Troubleshooting Easier

Allowing support of packaging printing color variation, and helping to reduce downtime

R: 1780
G: 1570
B: 580

R: 2350
G: 2080
B: 830

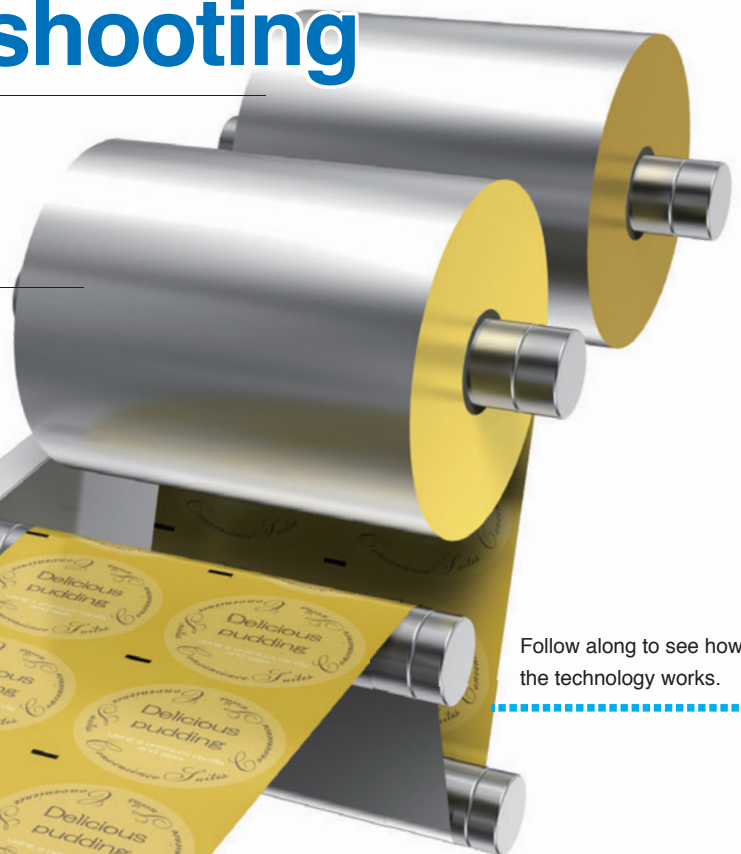

Follow along to see how the technology works.



Visualization of Color Variation

RGB Data Transmission Function

RGB information for color marks and backgrounds for each lot is transmitted to a host and quantified. This information is then managed in a database, making it possible to set optimal thresholds and identify causes quickly if a problem occurs.

During commissioning Until now, setting the threshold during commissioning required the knowledge of an expert. Now it is possible to get the optimal setting just by registering the RGB ratio of the packaging.

During maintenance When the Sensor makes false detection, values can be checked to determine whether color variation from lot to lot in packaging material has occurred, making it easy to identify what has caused a problem and to then resolve it.

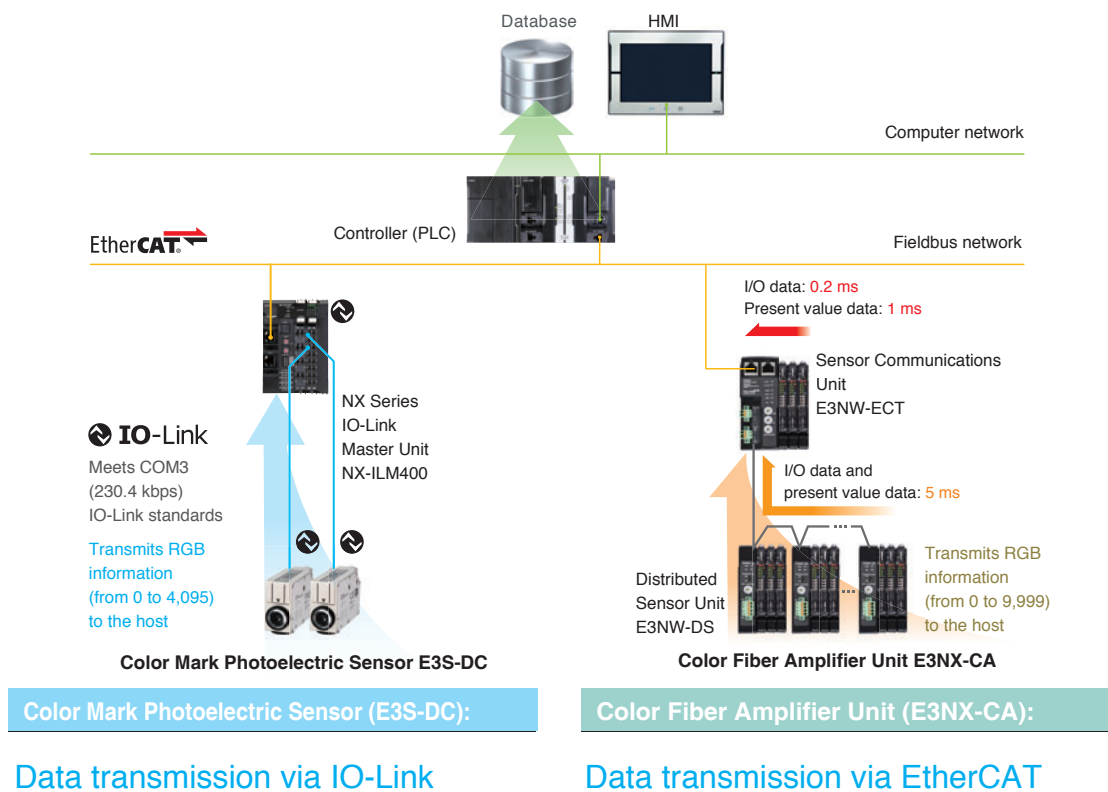

Further Information



Test Parameter Support Function *1

The test parameter support function allows users to determine whether or not detection is possible for designs in the prototyping stage. Package designers and production engineers use quantified RGB digital data to discuss the designs, which allows them to reach a quick decision on which design to use—and helps shorten lead times from design to production line commissioning.

Examine values that can be detected based on RGB data, then provide feedback on the design.

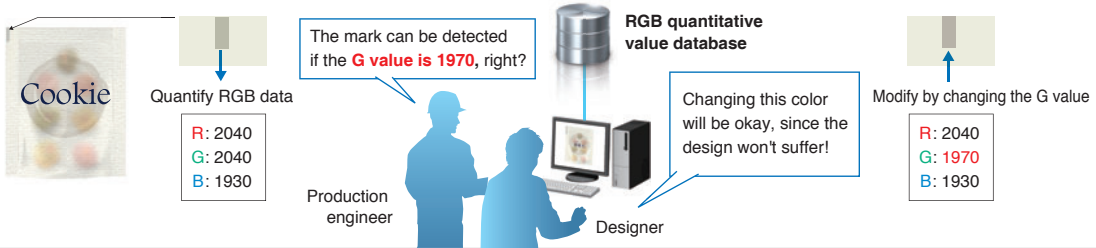

*1 Made possible through using a function that transmits RGB data via IO-Link (for E3S-DS) or EtherCAT (for E3NX-CA) to build a system that covers everything from Sensors to the computer network.

Color Mark Photoelectric Sensor

E3S-DC

Color Mark Detection on Any Type of Packaging.

Narrow Beam and Large Lens for Stable Detection of Workpieces Tilted at Various Angles.



For the most recent information on models that have been certified for safety standards, refer to your OMRON website.

- Detects subtle color differences.
High luminance, three-element (RGB) LED light source for greater light intensity. Highly efficient optics technology provides high power and enables stable detection even of subtle color differences.
- Handles glossy workpieces.
Thorough noise reduction.
High dynamic range covers everything from black to mirror surfaces.
- IoT compatible.
Models that support IO-Link also available.
Sends RGB information to host with high-speed IO-Link communications.
Optimum threshold set to reduce false detection.

Refer to *Safety Precautions* on page 16.

Ordering Information

Sensors (Refer to *Dimensions* on page 17.)

Red light, Green light, Blue light

Sensing method	Appearance	Connection method	Sensing distance	Output	Model	IO-Link baud rate *
Diffuse-reflective (mark detection)		M12 connector	10±3 mm	Push-pull	E3S-DCP21-IL2	COM2 (38.4 kbps)
					E3S-DCP21-IL3	COM3 (230.4 kbps)
				NPN	E3S-DCN21	Not supported

Note: Please contact your OMRON sales representative regarding the IO-Link setup file (IODD file).
* Refer to *Ratings and Specifications* on page 12 for the baud rate.

Accessories (Sold Separately)

Sensor I/O Connectors (Required for a Sensor with a connector.)

Connectors are not provided with the Sensors. Be sure to order a Connector separately.

Size	Type	Appearance	Cable length	Model
M12	Socket on one cable end	Straight	2 m	XS2F-D421-D80-F
			5 m	XS2F-D421-G80-F
		L-shape *2	2 m	XS2F-D422-D80-F
			5 m	XS2F-D422-G80-F
	Socket and plug on cable ends *1	Smartclick connector Straight/straight	2 m	XS5W-D421-D81-F
			5 m	XS5W-D421-G81-F
Smartclick connector L-shape/L-shape *2		2 m	XS5W-D422-D81-F	
		5 m	XS5W-D422-G81-F	

Note: 1. Refer to *Sensor I/O Connectors/Sensor Controllers* on your OMRON website for details.
The XS2W (Socket and Plug on Cable Ends) and XS5F (Socket on One Cable End) are also available.
2. The connectors will not rotate after they are connected.

*1. There are also straight type/L-shape type combinations available.
*2. The cable is fixed at an angle of 180° from the sensor emitter/receiver surface.

Ratings and Specifications

Item	Sensing method Output Model	Diffuse-reflective (mark detection)		
		Push-pull		NPN
		E3S-DCP21-IL2	E3S-DCP21-IL3	E3S-DCN21
Sensing distance	10 ±3 mm (White paper 10 ×10 mm)			
Spot size (reference value)	1 × 4 mm			
Light source (wavelength)	Red LED (635 nm), Green LED (525 nm), Blue LED (465 nm)			
Power supply voltage	10 to 30 VDC±10% (Ripple (p-p) 10% max.)			
Power consumption	960 mW max. (Reference: Power supply voltage 24 V, Current consumption 40 mA max.)			
Control output	Load current: 100 mA max. (30 VDC max.)			
Indications	Operation indicator (orange), RUN indicator (green), 7-segment indicator (white), Key lock indicator (white), Timer indicator (white), 1-point teaching mode indicator (white)			
Operation mode	High when mark is detected.		ON when mark is detected.	
Protection circuits	Power supply reverse polarity protection, output short-circuit protection and output incorrect connection protection			
Response time	Operate or reset: 50 μs max. for each (2-point teaching mode) Operate or reset: 150 μs max. for each (1-point teaching mode)			
Sensitivity adjustment	Teaching method			
Ambient illumination	Incandescent lamp: 3,000 lx max.			
Ambient temperature range	Operating: -10 to 55°C; Storage: -25 to 70°C (with no icing or condensation)			
Ambient humidity range	Operation: 35% to 85%, Storage: 35% to 95% (with no condensation)			
Insulation resistance	20 MΩ min. (at 500 VDC)			
Dielectric strength	1,000 VAC, 50/60 Hz for 1 min			
Vibration resistance	Destruction: 10 to 55 Hz with double amplitude of 1.5 mm for 2 hours each in X, Y, and Z directions			
Shock resistance	Destruction: 500 m/s ² 3 times each in X, Y, and Z directions			
Degree of protection	IEC 60529 IP67			
Connection method	M12, 4-pin connector			
Weight (packed state/Sensor only)	Model with connector	Approx. 370 g/approx. 320 g		
Materials	Case	Diecast zinc (nickel-plated brass)		
	Lens	Methacrylic resin (PMMA)		
	Indicators	ABS		
	Buttons	Elastomers		
	Connector	Diecast zinc (nickel-plated brass)		
Main IO-Link functions	<ul style="list-style-type: none"> • Operation mode switching between NO and NC • Timer function of the control output and timer time selecting function (Select a function from disabled, ON delay, OFF delay, one-shot or ON/OFF delay.) (Select a timer time of 1-5000 ms.) • Selecting function of ON delay timer time for instability (0 (disabled)-1000 ms) • Monitor output function (PD output indicating a relative detection quantity) • Energizing time read-out function (unit: h) • Initialize the settings function "Restore the factory settings" 		---	
Communication specifications	IO-Link specification	Version 1.1		
	Baud rate	E3S-DCP21-IL3: COM3 (230.4 kbps), E3S-DCP21-IL2: COM2 (38.4 kbps)		
	Data length	PD size: 8 bytes, OD size: 1 byte (M-sequence type: TYPE_2_2)		
	Minimum cycle time	E3S-DCP21-IL3 (COM3): 1.5 ms, E3S-DCP21-IL2 (COM2): 4.8 ms		
Accessories	Instruction manual			

* Standard Sensing Object for the Mark Sensor

Color	Munsell code
White	N9.5
Red	4R 4.5/12.0
Yellow-red	4YR 6.0/11.5
Yellow	5Y 8.5/11.0
Yellow-green	3GY 6.5/10.0
Green	3G 6.5/9.0
Blue-green	5BG 4.5/10.0
Blue	3PB 5.0/10.0
Blue-purple	9PB 5.0/10.0
Purple	7P 5.0/10.0
Red-purple	6RP 4.5/12.5
(Black)	(N2.0)

Engineering Data (Reference Value)

Color vs. Detection Capability

E3S-DC

Teaching Capabilities

	White	Red	Yellow-red	Yellow	Yellow-green	Green	Blue-green	Blue	Blue-purple	Purple	Red-purple	Black
White	○	○	○	○	○	○	○	○	○	○	○	○
Red	○	○	○	○	○	○	○	○	○	○	○	○
Yellow-red	○	○	○	○	○	○	○	○	○	○	○	○
Yellow	○	○	○	○	○	○	○	○	○	○	○	○
Yellow-green	○	○	○	○	○	○	○	○	○	○	○	○
Green	○	○	○	○	○	○	○	○	○	○	○	○
Blue-green	○	○	○	○	○	○	○	○	○	○	○	○
Blue	○	○	○	○	○	○	○	○	○	○	○	○
Blue-purple	○	○	○	○	○	○	○	○	○	○	○	○
Purple	○	○	○	○	○	○	○	○	○	○	○	○
Red-purple	○	○	○	○	○	○	○	○	○	○	○	○
Black	○	○	○	○	○	○	○	○	○	○	○	○

Note: The above chart shows the combinations of colors for which teaching is possible at a sensing distance of 10 mm.

Detectable Ranges

E3S-DC

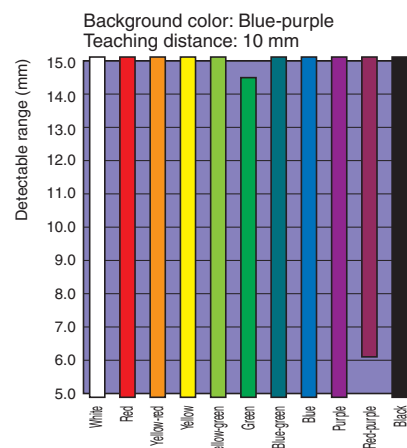
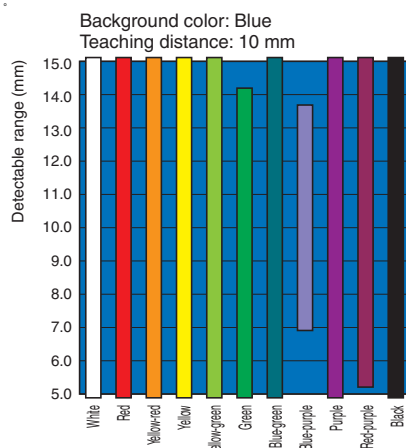
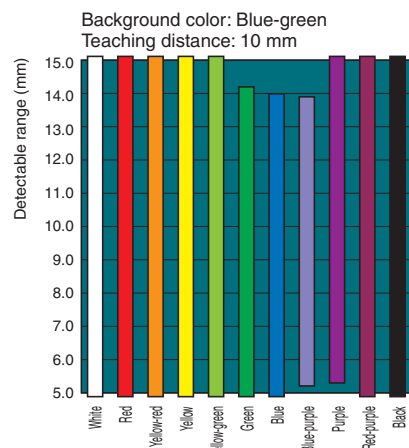
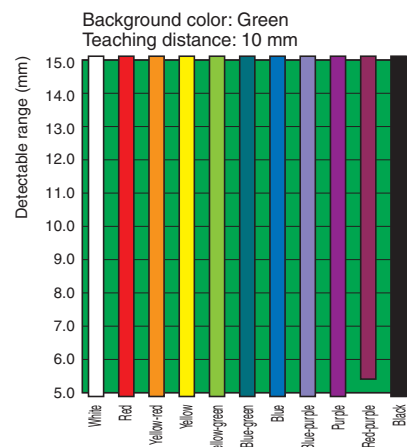
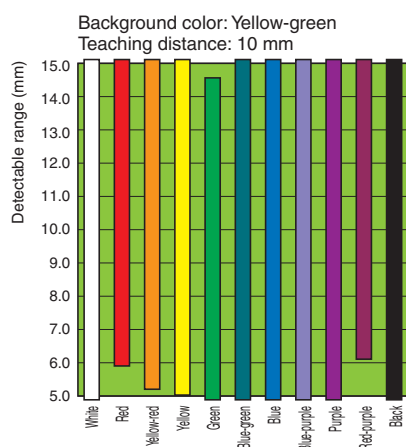
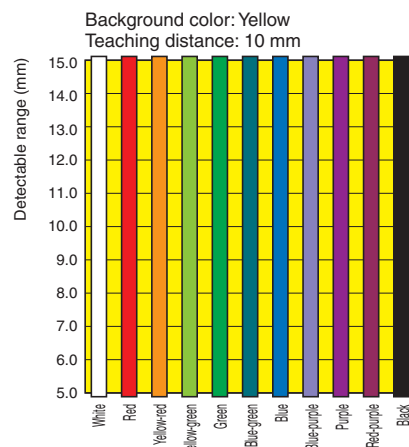
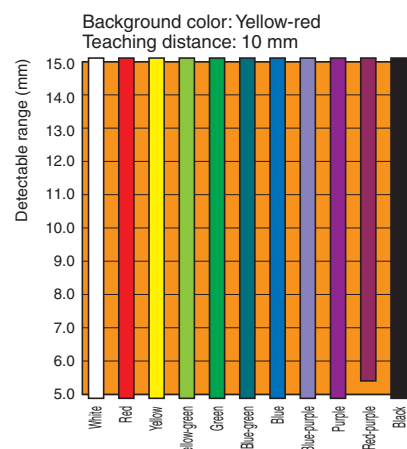
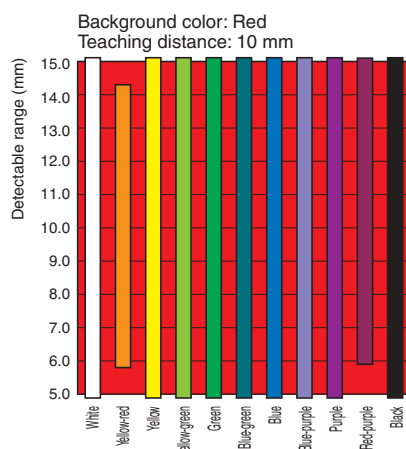
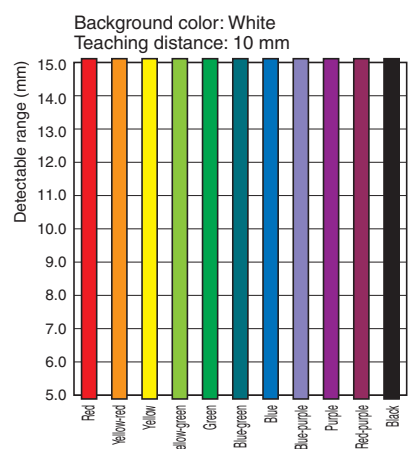

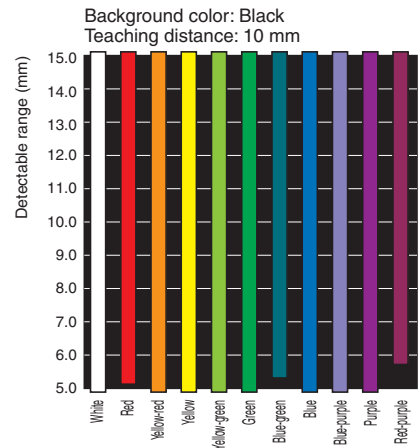
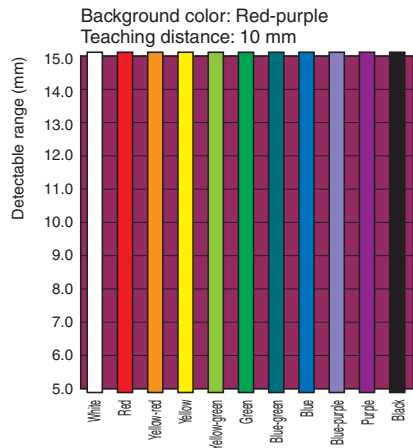
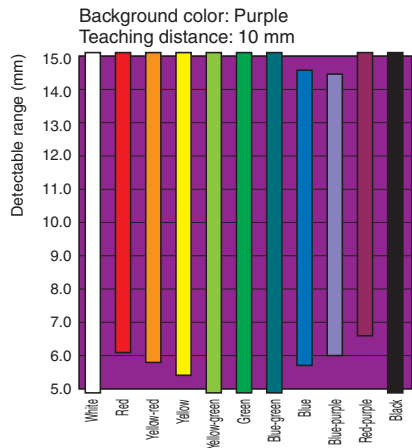

Excess Gain vs. Distance

E3S-DC

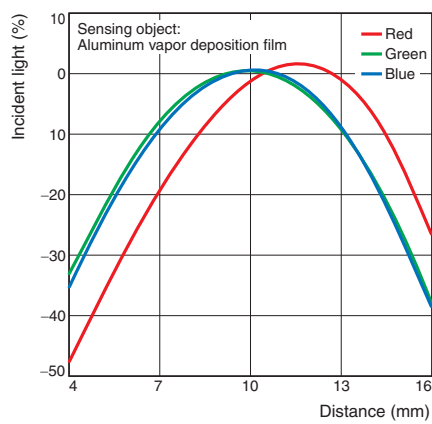
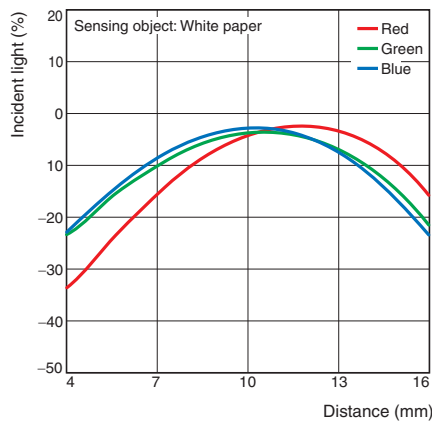

Angle vs. Incident Characteristics

E3S-DC

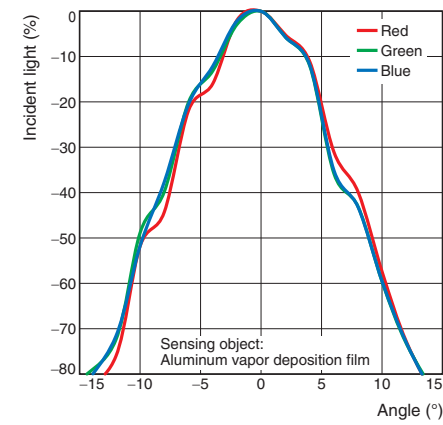
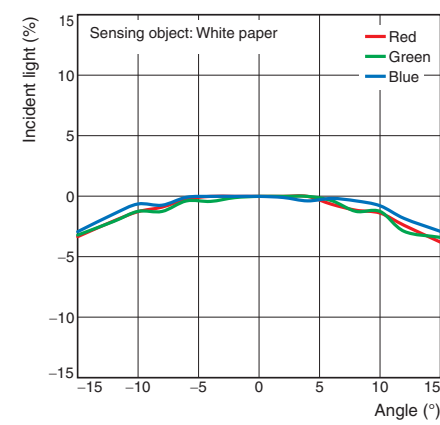

I/O Circuit Diagrams

Push-Pull Output

Model	Output mode	NO/NC setting *4	Timing chart	Output circuit
E3S-DCP21-IL2 E3S-DCP21-IL3	Standard I/O mode (SIO mode) (Pin 2 Output Settings)	NO *5		<p>Using Pin 2 as an external input *1 (enabled by default)</p>
		NC		<p>Using Pin 2 with a control output *1 (set for IO-Link)</p>
	IO-Link mode (Pin 2 Output Settings)	NO *5		<p>IO-Link Master</p>
		NC		

*1. Pin 2 input/output can be switched with the IO-Link communication command "Switchpoint Pin 2".

*2. In case of NPN connection, please connect the load between Pin 1 and Pin 4.

*3. In case of PNP connection, please connect the load between Pin 1 and Pin 4.

*4. It can be switched in IO-Link.

*5. Factory default

Note: 1. You can use IO-Link communications to reverse the operation logic, set an output delay, and change between an input and output.
2. Please contact your OMRON sales representative regarding assignment of data.

NPN Output

Model	Timing chart	Output circuit
E3S-DCN21		

Plugs (Sensor I/O Connectors)

M12, 4-pin Connector

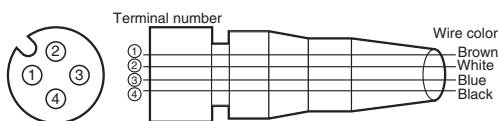

Classification	Wire color	Connector pin No.	Application	
			E3S-DCP21-IL2 E3S-DCP21-IL3	E3S-DCN21
DC	Brown	①	Power supply (+V)	Power supply (+V)
	White	②	External input *	External input
	Blue	③	Power supply (0 V)	Power supply (0 V)
	Black	④	Output C/Q	Control output

* It can be set as the control output with IO-Link.

Nomenclature

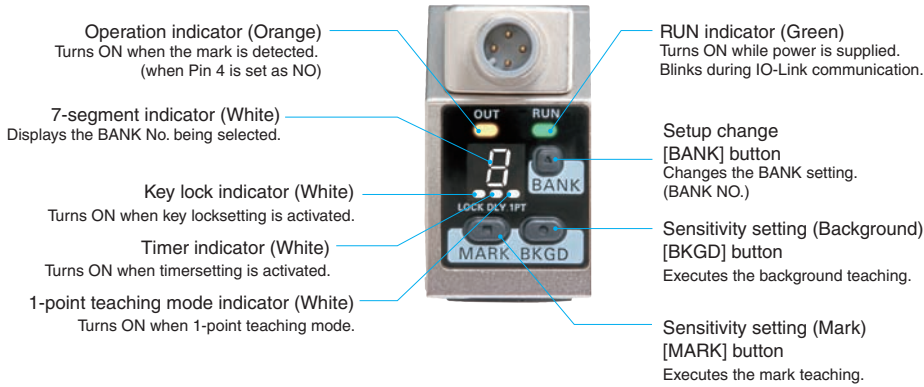

Safety Precautions

Be sure to read the precautions for all models in the website at: <http://www.ia.omron.com/>.

Warning Indications

	Warning level Indicates a potentially hazardous situation which, if not avoided, will result in minor or moderate injury, or may result in serious injury or death. Additionally, there may be significant property damage.
Precautions for Safe Use	Supplementary comments on what to do or avoid doing, to use the product safely.
Precautions for Correct Use	Supplementary comments on what to do or avoid doing, to prevent failure to operate, malfunction or undesirable effect on product performance.

Meaning of Product Safety Symbols

	General prohibition Indicates the instructions of unspecified prohibited action.
	Caution, explosion Indicates the possibility of explosion under specific conditions.
	Caution, fire Indicates the possibility of fire under specific conditions.
	General caution Indicates unspecified general alert.

⚠ WARNING

This product is not designed or rated for ensuring safety of persons either directly or indirectly. Do not use it for such purpose.

Never use the product with an AC power supply. Otherwise, explosion may result.

Do not use the product with voltage in excess of the rated voltage. Excess voltage may result in malfunction or fire.

Be sure to tighten the external lens until it reaches the chassis.

Precautions for Safe Use

The following precautions must be observed to ensure safe operation of the product.

1. Do not install the product in the following locations.
 - Locations subject to direct sunlight
 - Locations subject to condensation due to high humidity
 - Locations subject to corrosive gas
 - In the place where vibration or shock is directly transmitted to the product.
2. Do not use the product in environments subject to flammable or explosive gases.
3. Do not use the product in any atmosphere or environment that exceeds the ratings.
4. Do not pull on the cable with excessive strength.
5. Do not attempt to disassemble, repair, or modify the product in any way.
6. Do not use the product with the main unit damaged.
7. Be sure that before making supply the supply voltage is less than the maximum rated supply voltage (30 VDC).
8. Do not apply any load exceeding the ratings.
9. Do not short the load. Otherwise damage or fire may result.
10. Connect the load correctly.
11. Do not use the product under a chemical or an oil environment without prior evaluation.
12. Though this is type IP67, do not use in the water, rain or outdoors.
13. Do not use thinner, alcohol, or other organic solvents. Otherwise, the optical properties and degree of protection may be degraded.
14. When disposing of the product, treat it as industrial waste.
15. These Sensors are certificated for the UL standard on the assumption of usage in a Class 2 circuit. Use them with Class 2 power supplies in the United States or Canada. Use the OMRON XS2F-D4-series or XS5F-D4-series Cables. Cables that have wires less than AWG24 (0.2 mm²) are for connection to terminal blocks and are not for field splicing. External overcurrent protection of 1 A for AWG26, 2 A for AWG24, or 3 A for AWG22 wire must be provided for cable protection.

Precautions for Correct Use

1. Note that the water-resistant function is impaired if installing the Photoelectric Sensor by hitting it with a hammer and so on.
2. Be sure to tighten the external lens until it reaches the chassis.
3. If the Sensor wiring is placed in the same conduits or ducts as high-voltage or high-power lines, inductive noise may cause malfunction or damage. Wire the cables separately or use a shielded cable.
4. To extend a cable in the standard I/O mode, use a cable of 0.3 mm² or more and keep the length 100 m or less. Keep the length 20 m or less if using the Sensor in the IO-Link mode.
5. Apply a screw tightening torque of 2.0 N·m or less.

6. If a commercial switching regulator is used, ground the FG (frame ground) terminal.
7. The Sensor will be able to detect objects 100 ms after the power supply is tuned ON. Start using the Sensor 100 ms or more after turning ON the power supply. If the load and the Sensor are connected to separate power supplies, be sure to turn ON the Sensor first.
8. Do not press the button with anything sharp such as a screwdriver because it might be damaged.
9. Output pulses may occur when the power supply is turned OFF. We recommend that you turn OFF the power supply to the load or load line first.

Dimensions

(Unit: mm)
Tolerance class IT16 applies to dimensions in this data sheet unless otherwise specified.

Sensors

Diffuse-reflective Models

- E3S-DCP21-IL2
- E3S-DCP21-IL3
- E3S-DCN21

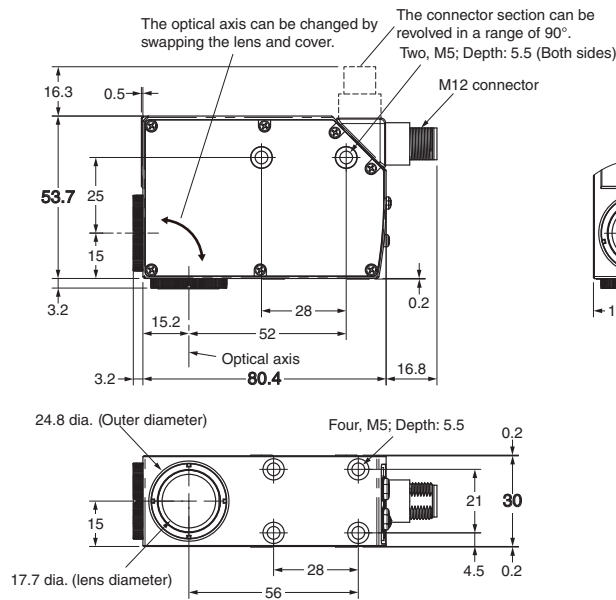

- Note:**
1. Apply a screw tightening torque of 2.0 N·m or less.
 2. Be sure to tighten the external lens or cover until it reaches the chassis.

Color Fiber Amplifier Unit E3NX-CA

**Smart Fiber Amplifier Units with White LEDs.
High Color Discrimination Capability with the Same
Easy Operation as Previous Fiber Amplifier Units.
Existing General-purpose Fiber Units Can Be
Connected.**



- Detects subtle color differences.
The new white LED optic system increases the light intensity and the low-noise circuit in the Smart Fiber Amplifier Unit provides a surprising detection capability.
- Handles glossy workpieces.
Smart Tuning lets you set the optimum sensitivity for detection with one simple operation.
- IoT compatible.
The detected RGB data can be displayed on the Amplifier Unit, and the Amplifier Unit for communications can transfer this data to the host in realtime.



For the most recent information on models that have been certified for safety standards, refer to your OMRON website.

Refer to *Safety Precautions* on page 30.

Ordering Information

Fiber Amplifier Units (Refer to *Dimensions* on pages 31 and 32.)

Type	Appearance	Connecting method	Inputs/outputs	Model	
				NPN output	PNP output
Standard models		Pre-wired (2 m)	1 output	E3NX-CA11 2M	E3NX-CA41 2M
		Wire-saving Connector	1 output	E3NX-CA6	E3NX-CA8
Advanced models		Pre-wired (2 m)	2 outputs + 1 input	E3NX-CA21 2M	E3NX-CA51 2M
Model for Sensor Communications Unit *		Connector for Sensor Communications Unit	---	E3NX-CA0	

* A Sensor Communications Unit is required if you want to use the Fiber Amplifier Unit on a network.
Note: Refer to your OMRON website for details on models with wire-saving connectors.

Fiber Units (Refer to *Dimensions* on page 32.)

Sensing method	Appearance	Sensing direction	Size	Model
Reflective		Right-angle	M6	E32-C91N 2M
Through-beam (Grooved type)		Array	10 mm	E32-G16 2M

Note: Refer to *Fiber Units* on your OMRON website or to the *Fiber Sensor Best Selection Catalog* (Cat. No. E418-E1) for details on Fiber Units.

Accessories (Sold Separately)

Wire-saving Connectors (Required for models for Wire-saving Connectors.) (Refer to Dimensions on page 33.)

Connectors are not provided with the Fiber Amplifier Unit and must be ordered separately. *Protective stickers are provided.

Type	Appearance	Cable length	No. of conductors	Model	Applicable Fiber Amplifier Units
Master Connector		2 m	3	E3X-CN11	E3NX-CA6 E3NX-CA8
Slave Connector			1	E3X-CN12	

Note: Models are also available with a 5-m cable. The model names have the suffix 5M. Ask your OMRON representative for delivery times.

Mounting Bracket (Refer to Dimensions on page 33.)

A Mounting Bracket is not provided with the Fiber Amplifier Unit. It must be ordered separately as required.

Appearance	Model	Quantity
	E39-L143	1

DIN Tracks (Refer to Dimensions on page 34.)

A DIN Track is not provided with the Fiber Amplifier Unit. It must be ordered separately as required.

Appearance	Type	Model	Quantity
	Shallow type, total length: 1 m	PFP-100N	1
	Shallow type, total length: 0.5 m	PFP-50N	
	Deep type, total length: 1 m	PFP-100N2	

Note: Refer to PFP-□ on your OMRON website for details.

End Plate (Refer to Dimensions on page 34.)

Two End Plates are provided with the Sensor Communications Unit.



End Plates are not provided with the Fiber Amplifier Unit. They must be ordered separately as required.

Appearance	Model	Quantity
	PFP-M	1

Note: Refer to PFP-M on your OMRON website for details.

Related Products

Sensor Communications Units

Type	Appearance	Model
Sensor Communications Unit for EtherCAT		E3NW-ECT
Distributed Sensor Unit		E3NW-DS

Note: Refer to your OMRON website for details.

EtherCAT® is a registered trademark and patented technology, licensed by Beckhoff Automation GmbH, Germany.

Ratings and Specifications

Item	Type	Standard models		Advanced models	Model for Sensor Communications Unit *1	
		NPN output	E3NX-CA11	E3NX-CA6	E3NX-CA21	E3NX-CA0
		PNP output	E3NX-CA41	E3NX-CA8	E3NX-CA51	
Connecting method		Pre-wired	Wire-saving Connector	Pre-wired	Connector for Sensor Communications Unit	
I/O	Outputs	1 output		2 outputs	--- *3	
	External input	---		1 input *2		
Light source (wavelength)		White LED (420 to 700 nm)				
Supply voltage		10 to 30 VDC, including 10% ripple (p-p)			Supplied from the connector through the Sensor Communications Unit.	
Power consumption *4		At Power Supply Voltage of 24 VDC Normal mode: 960 mW max. (Current consumption: 40 mA max.) Eco function ON: 720 mW max. (Current consumption: 30 mA max.) Eco function LO: 800 mW max. (Current consumption: 33 mA max.)				
Control output		Load power supply voltage: 30 VDC max., open-collector output Load current: Groups of 1 to 3 Amplifiers: 100 mA max., Groups of 4 to 30 Amplifiers: 20 mA max. (Residual voltage: At load current of less than 10 mA: 1 V max.) At load current of 10 to 100 mA: 2 V max.) OFF current: 0.1 mA max.			---	
Indications		7-segment displays (Sub digital display: green, Main digital display: white) Display direction: Switchable between normal and reversed. OUT indicator (orange), NO/NC indicator (orange), Smart Tuning indicator (blue), and OUT selection indicator (orange, only on models with 2 outputs)				
Protection circuits		Power supply reverse polarity protection, output short-circuit protection, and output reverse polarity protection			Power supply reverse polarity protection	
Sensing method		Contrast Mode: Light intensity discrimination for RGB (initial state/after 2-point tuning) (R+G+B light intensity discrimination for 1-point tuning) Color Mode: RGB ratio discrimination				
Response time	Super-high-speed Mode (SHS) *5	Operate or reset: 50 μs (only in Contrast Mode)				
	High-speed Mode (HS)	Operate or reset: 250 μs				
	Standard Mode (Stnd)	Operate or reset: 1 ms				
	Giga-power Mode (GIGA)	Operate or reset: 16 ms				
Sensitivity adjustment		Smart Tuning (2-point tuning, full autotuning, or 1-point tuning (1% to 99%)) or manual adjustment				
Maximum connectable Units		30 Units			30 Units (When connected to OMRON NJ-series Unit)	
No. of Units for mutual interference prevention *6	Super-high-speed Mode (SHS) *5	---				
	High-speed Mode (HS)	10 Units				
	Standard Mode (Stnd)	10 Units				
	Giga-power Mode (GIGA)	10 Units				

*1. The E3NW-ECT Sensor Communications Unit can be used, but the E3NW-CRT/CCL, E3X-DRT21-S, and E3X-CRT/ECT Sensor Communications Units cannot be used.

*2. The following details apply to the input.

	Contact input (relay or switch)	Non-contact input (transistor)
NPN	ON: Shorted to 0 V (Sourcing current: 2 mA max.). OFF: Open or shorted to Vcc.	ON: 1.5 V max. (Sourcing current: 2 mA max.) OFF: Vcc - 1.5 V to Vcc (Leakage current: 0.1 mA max.)
PNP	ON: Shorted to Vcc (Sinking current: 3 mA max.). OFF: Open or shorted to 0 V.	ON: Vcc - 1.5 V to Vcc (sinking current: 3 mA max.) OFF: 1.5 V max. (Leakage current: 0.1 mA max.)

*3. Two sensor outputs are allocated in the programmable logic controller (PLC) I/O table.

PLC operation via Communications Unit enables reading detected values and changing settings.

*4. Power consumption

At Power Supply Voltage of 10 to 30 VDC

Normal mode: 1,080 mW max. (Current consumption: 36 mA max. at 30 VDC, 74 mA max. at 10 VDC)

Eco function ON: 840 mW max. (Current consumption: 28 mA max. at 30 VDC, 50 mA max. at 10 VDC)

Eco function LO: 930 mW max. (Current consumption: 31 mA max. at 30 VDC, 55 mA max. at 10 VDC)

*5. The mutual interference prevention function is disabled if the detection mode is set to Super-high-speed Mode.

*6. The tuning will not change the number of units.

The least unit count among the mutual interference prevention units of E3NX and E3NC.

Check the mutual interference prevention unit count and response speed of each model.

E3NX-CA

Item	Type	Standard models		Advanced models	Model for Sensor Communications Unit *1
	NPN output	E3NX-CA11	E3NX-CA6	E3NX-CA21	E3NX-CA0
	PNP output	E3NX-CA41	E3NX-CA8	E3NX-CA51	
Connecting method	Pre-wired	Wire-saving Connector	Pre-wired	Connector for Sensor Communications Unit	
Functions	Operation mode	Contrast Mode: NO (Light-ON) or NC (Dark-ON) Color Mode: NO (ON for match: ON for same color as registered color) or NC (ON for mismatch: ON for different color from registered color)			
	Timer	Select from timer disabled, OFF-delay, ON-delay, one-shot, or ON-delay + OFF-delay timer (Counted by 0.1 s in a range of 0.1 to 0.5 ms, by 0.5 ms for 0.5 to 5 ms, and by 1 ms for 5 to 9999 ms. Default: 10 ms, Error: 0.1 ms)			
	Zero reset	Contrast Mode only Negative values can be displayed. (Threshold level is shifted.)			
	Resetting settings *7	Select from initial reset (factory defaults), user reset (saved settings), or bank reset.			
	Eco mode	Select from OFF (digital display lit), Eco ON (digital display not lit), and Eco LO (digital display dimmed).			
	Bank switching	Select from banks 1 to 8.			
	Power tuning level	Set from 100 to 9,999. (The RGB maximum incident level at Smart Tuning is adjusted to the power tuning level.)			
	Output 2	---	Normal, error output, AND output, or OR output		---
	External input	---	Select from input OFF, tuning, full-auto tuning, emission OFF, bank 1 and 2 switching, bank 1 through 8 switching, or zero reset.		---
Changing the displays	Threshold level and incident level, channel number and incident level, RGB display and incident level, or bank display and incident level				
Ambient illumination (Receiver side)	Incandescent lamp: 20,000 lx max., Sunlight: 30,000 lx max.				
Ambient temperature range	Operating: Groups of 1 or 2 Amplifier Units: -25 to 55°C, Groups of 3 to 10 Amplifier Units: -25 to 50°C, Groups of 11 to 16 Amplifier Units: -25 to 45°C, Groups of 17 to 30 Amplifier Units: -25 to 40°C Storage: -30 to 70°C (with no icing or condensation)			Operating: Groups of 1 or 2 Amplifier Units: 0 to 55°C, Groups of 3 to 10 Amplifier Units: 0 to 50°C, Groups of 11 to 16 Amplifier Units: 0 to 45°C, Groups of 17 to 30 Amplifier Units: 0 to 40°C Storage: -30 to 70°C (with no icing or condensation)	
Ambient humidity range	Operating and storage: 35% to 85% (with no condensation) within the surrounding air temperature range shown above				
Installation environment	Pollution degree 3 (as per IEC 60947-1)				
Insulation resistance	20 MΩ min. (at 500 VDC)				
Dielectric strength	1,000 VAC at 50/60 Hz for 1 minute				
Vibration resistance	10 to 55 Hz with a 1.5-mm double amplitude for 2 hours each in X, Y, and Z directions				
Shock resistance (destruction)	500 m/s ² for 3 times each in X, Y, and Z directions			150 m/s ² for 3 times each in X, Y, and Z directions	
Weight (packed state/Sensor only)	Approx. 115 g/ approx. 75 g	Approx. 60g/ approx. 20g	Approx. 115 g/approx. 75 g		Approx. 65 g/approx. 25 g
Materials	Case	Polycarbonate (PC)			
	Cover	Polycarbonate (PC)			
	Cable covering	Polyvinyl chloride (PVC)			---
Accessories	Instruction manual				

*7. The bank is not reset by the user reset function or saved by the user save function.

Sensing Distances

Specifications

Hex-shaped Models

Type			Appearance (mm)	Bending radius of cable (mm)	Sensing distance (mm)								Model
Sensing method	Size	Aperture angle			White paper				12-color discrimination				
			GIGA	ST	HS	SHS	GIGA	ST	HS	SHS			
Reflective	M6	60°		Flexible, R4	90	45	30	13	18	9	6	4	E32-C91N 2M

Through-beam Models (Grooved Type)

Type	Sensing width	Appearance (mm)	Bending radius of cable (mm)	Sensing distance (mm)								Model
				Opaque object				Translucent object				
				GIGA	ST	HS	SHS	GIGA	ST	HS	SHS	
Array	10 mm		R5	10								E32-G16 2M

Installation Information

Model	Installation			Cable						Weight (packed state)
	Ambient temperature	Tightening torque	Mounting hole	Bending radius (mm)	Unbendable length (mm)	Tensile strength	Sheath material	Core material	Emitter/receiver differentiation	
E32-C91N 2M	-40 to 70°C	0.98 N·m	6.2 ^{+0.5} ₀ dia.	R4	0	29.4 N	Polyethylene	Plastic	White line on emitter cable	36 g
E32-G16 2M	-40 to 70°C	0.53 N·m	---	R5	0*	29.4 N	Polyethylene	Plastic	---	51 g

* The bending radius of the protective cover (PVC, 25 mm) is 10 mm min.

Hex-shaped Models

Sensing method	Size	Aperture angle	Model	Sensing distance (mm)							
				Reflective: White paper, Through-beam: Opaque object				Reflective: 12-color discrimination, Through-beam: Translucent object *1			
				GIGA	Standard	High-speed	Super-high-speed	GIGA	Standard	High-speed	Super-high-speed *2
Through-beam	M4	15°	E32-LT11N 2M (Built-in Lens)	980	510	350	140	190	100	70	44
			E32-T11N 2M	300	150	100	45	60	31	21	13
Reflective	M3	60°	E32-C21N 2M	54	27	18	7	10	5	3.6	2.6
			E32-D21N 2M	90	45	30	13	18	9	6	4
	M6	15°	E32-LD11N 2M (Built-in Lens)	88	44	29	13	17	8	5	4
			M3	60°	E32-C31N 2M	12	6	4	1.8	2.4	1.2
					E32-C11N 2M	90	45	30	13	18	9
Retro-reflective for transparent object detection	M6	15°	E32-LR11NP 2M (Built-in Lens) + E39-RP1 (Reflector, sold separately)	370	180	120	55	75	37	25	16

*1. These sensing distances are recommended to make the most of the detection capabilities of the Sensor.

*2. The Super-high-speed Mode for 12-color discrimination with a Reflective Sensor or for detection of translucent objects with a Through-beam Sensor can be set only in Contrast Mode. The Super-high-speed Mode can not be set in Color Mode.

Threaded Models

Sensing method	Size	Aperture angle	Model	Sensing distance (mm)							
				Reflective: White paper, Through-beam: Opaque object				Reflective: 12-color discrimination, Through-beam: Translucent object *1			
				GIGA	Standard	High-speed	Super-high-speed	GIGA	Standard	High-speed	Super-high-speed *2
Through-beam	M4	60°	E32-T11R 2M	300	150	100	45	60	31	21	13
			E32-LT11 2M (Built-in Lens)	1,150	600	410	170	230	120	82	52
			E32-LT11R 2M (Built-in Lens)	980	510	350	140	190	100	70	44
Reflective	M6	15°	E32-LD11 2M (Built-in Lens)	92	46	30	13	18	9	6	4
			E32-LD11R 2M (Built-in Lens)	88	44	29	13	17	8	5	4
	M3	60°	E32-C31 2M	37	18	12	5	7	3.8	2.5	1.8
			E32-D11R 2M	90	45	30	13	18	9	6	4
			E32-CC200 2M	150	75	50	22	30	15	10	7

Cylindrical Models

Sensing method	Sensing direction	Size	Model	Sensing distance (mm)							
				Reflective: White paper, Through-beam: Opaque object				Reflective: 12-color discrimination, Through-beam: Translucent object *1			
				GIGA	Standard	High-speed	Super-high-speed	GIGA	Standard	High-speed	Super-high-speed *2
Through-beam	Top-view	1.5 dia.	E32-T22B 2M	110	64	37	16	22	12	7	5
		3 dia.	E32-T12R 2M	300	150	100	45	60	31	21	13
	Side-view		E32-T14LR 2M	190	100	68	29	38	20	13	8
Reflective	Top-view	1.5 dia.	E32-D22B 2M	17	8	6	2.4	3	2	1.2	0.7
		3 dia.	E32-D221B 2M	38	20	13	5	7	4	3	1.7
			E32-D32L 2M	85	44	30	12	17	8	6	3.7

Flat Models

Sensing method	Sensing direction	Model	Sensing distance (mm)							
			Reflective: White paper, Through-beam: Opaque object				Reflective: 12-color discrimination, Through-beam: Translucent object *1			
			GIGA	Standard	High-speed	Super-high-speed	GIGA	Standard	High-speed	Super-high-speed *2
Through-beam	Flat-view	E32-LT35Z 2M (Built-in Lens)	360	190	130	55	73	38	26	16
	Top-view	E32-T15XR 2M	300	150	100	45	60	31	21	13
	Side-view	E32-T15YR 2M	190	100	68	29	38	20	13	8
	Flat-view	E32-T15ZR 2M	190	100	68	29	38	20	13	8
Reflective	Top-view	E32-D15XR 2M	90	45	30	13	18	9	6	4
	Side-view	E32-D15YR 2M	21	10	7	3.1	4.2	2.1	1.4	1
	Flat-view	E32-D15ZR 2M	21	10	7	3.1	4.2	2.1	1.4	1

Sleeve Models

Sensing method	Sensing direction	Model	Sensing distance (mm)							
			Reflective: White paper, Through-beam: Opaque object				Reflective: 12-color discrimination, Through-beam: Translucent object *1			
			GIGA	Standard	High-speed	Super-high-speed	GIGA	Standard	High-speed	Super-high-speed *2
Through-beam	Top-view	E32-TC200BR 2M	300	150	100	45	60	31	21	13
Reflective		E32-DC200BR 2M	90	45	30	13	18	9	6	4

*1. These sensing distances are recommended to make the most of the detection capabilities of the Sensor.

*2. The Super-high-speed Mode for 12-color discrimination with a Reflective Sensor or for detection of translucent objects with a Through-beam Sensor can be set only in Contrast Mode. The Super-high-speed Mode can not be set in Color Mode.

Small-spot, Reflective Models

Sensing method	Type	Spot diameter	Center distance (mm)	Model	Sensing distance (mm)							
					Reflective: White paper, Through-beam: Opaque object				Reflective: 12-color discrimination, Through-beam: Translucent object *1			
					GIGA	Standard	High-speed	Super-high-speed	GIGA	Standard	High-speed	Super-high-speed *2
Reflective	Integrated lens, long-distance, small-spot	6 dia.	50	E32-L15 2M	Spot diameter of 6 mm at 50 mm. Sensing distance of 40 to 100 mm.				Spot diameter of 6 mm at 50 mm. Sensing distance of 40 to 85 mm.		Spot diameter of 6 mm at 50 mm. Sensing distance of 40 to 60 mm.	
	Parallel light	4 dia.	0 to 20	E32-C31 2M + E39-F3C	Spot diameter of 4 mm at 0 to 20 mm.				Spot diameter of 4 mm at 1 to 9 mm. *3		---	
	Small-spot	0.5 dia.	7	E32-C31 2M + E39-F3A-5	Spot diameter of 0.5 mm at 7 mm.		---		Spot diameter of 0.5 mm at 7 mm. *3		---	
			17	E32-C31 2M + E39-F3B	Spot diameter of 0.5 mm at 17 mm.		---		---		---	
		3 dia.	50	E32-CC200 2M + E39-F18	Spot diameter of 3 mm at 50 mm.		---		Spot diameter of 3 mm at 50 mm. *3		---	

High-power Beam Models

Sensing method	Sensing direction	Aperture angle	Model	Sensing distance (mm)							
				Reflective: White paper, Through-beam: Opaque object				Reflective: 12-color discrimination, Through-beam: Translucent object *1			
				GIGA	Standard	High-speed	Super-high-speed	GIGA	Standard	High-speed	Super-high-speed *2
Through-beam	Top-view	10°	E32-T17L 10M	8,570	200	130	59	1,710	40	27	17
	Side-view	30°	E32-T14 2M	1,910	990	680	290	380	190	130	87
	Right-angle	12°	E32-T11N 2M + E39-F1	1,470	760	520	220	290	150	100	66
	Top-view	12°	E32-T11R 2M + E39-F1	1,470	760	520	220	290	150	100	66
	Side-view	60°	E32-T11R 2M + E39-F2	180	98	67	28	37	19	13	8
	Top-view	12°	E32-T11 2M + E39-F1	2,430	1,260	860	360	480	250	170	110
	Side-view	60°	E32-T11 2M + E39-F2	310	160	110	47	62	32	22	14
	Top-view	12°	E32-T61-S 2M + E39-F1	1,080	560	380	160	210	110	76	49
Side-view	60°	E32-T61-S 2M + E39-F2	130	72	49	21	27	14	9	6	

Narrow View Models

Sensing method	Sensing direction	Aperture angle	Model	Sensing distance (mm)							
				Reflective: White paper, Through-beam: Opaque object				Reflective: 12-color discrimination, Through-beam: Translucent object *1			
				GIGA	Standard	High-speed	Super-high-speed	GIGA	Standard	High-speed	Super-high-speed *2
Through-beam	Side-view	4°	E32-T24S 2M	750	380	260	110	150	77	53	34
			E32-T22S 2M	1,070	550	380	160	210	110	76	48

Chemical-resistant, Oil-resistant Models

Sensing method	Type	Sensing direction	Model	Sensing distance (mm)							
				Reflective: White paper, Through-beam: Opaque object				Reflective: 12-color discrimination, Through-beam: Translucent object *1			
				GIGA	Standard	High-speed	Super-high-speed	GIGA	Standard	High-speed	Super-high-speed *2
Through-beam	Chemical/oil resistant	Top-view	E32-T12F 2M	1,710	880	600	260	340	170	120	78
			E32-T11F 2M	250	130	91	39	51	26	18	11
		Side-view	E32-T14F 2M	210	110	76	32	42	22	15	9
	Chemical/oil-resistant at 150°C	Top-view	E32-T51F 2M	770	400	270	110	150	80	54	35
Reflective	Chemical/oil resistant	Top-view	E32-D12F 2M	49	24	16	7	9	5	3	2.4
	Chemical-resistant cable		E32-D11U 2M	90	45	30	13	18	9	6	4

*1. These sensing distances are recommended to make the most of the detection capabilities of the Sensor.

*2. The Super-high-speed Mode for 12-color discrimination with a Reflective Sensor or for detection of translucent objects with a Through-beam Sensor can be set only in Contrast Mode. The Super-high-speed Mode can not be set in Color Mode.

*3. The sensing distances are given for Contrast Mode. The sensing distance cannot be set in Color Mode.

Bending-resistant Models

Sensing method	Size	Model	Sensing distance (mm)							
			Reflective: White paper, Through-beam: Opaque object				Reflective: 12-color discrimination, Through-beam: Translucent object *1			
			GIGA	Standard	High-speed	Super-high-speed	GIGA	Standard	High-speed	Super-high-speed *2
Through-beam	1.5 dia.	E32-T22B 2M	110	64	37	16	22	12	7	5
	M3	E32-T21 2M	100	57	33	14	20	11	6	4
	M4	E32-T11 2M	380	200	130	58	77	40	27	17
	Square	E32-T25XB 2M	77	43	25	10	15	8	5	3.3
Reflective	1.5 dia.	E32-D22B 2M	17	8	6	2.4	3	2	1.2	0.7
	M3	E32-D21 2M	17	8	6	2.4	3.4	1.8	1.2	0.7
	3 dia.	E32-D221B 2M	38	20	13	5	7	4	3	1.7
	M4	E32-D21B 2M	38	20	13	5	7	4	2.7	1.7
	M6	E32-D11 2M	90	45	30	13	18	9	6	4
	Square	E32-D25XB 2M	27	14	9	3.9	5	3	2	1.2

Heat-resistant Models

Sensing method	Heat-resistant temperature	Model	Sensing distance (mm)							
			Reflective: White paper, Through-beam: Opaque object				Reflective: 12-color discrimination, Through-beam: Translucent object *1			
			GIGA	Standard	High-speed	Super-high-speed	GIGA	Standard	High-speed	Super-high-speed *2
Through-beam	150°	E32-T51 2M	420	220	150	65	85	44	30	19
	200°	E32-T81R-S 2M	150	80	54	23	30	16	10	7
	350°	E32-T61-S 2M	250	130	91	39	51	26	18	11
Reflective	150°	E32-D51 2M	120	60	40	17	24	12	8	5
	200°	E32-D81R-S 2M	42	21	14	6	8	4.3	2.9	1.9
	350°	E32-D61-S 2M	42	21	14	6	8	4	2.9	1.9
	400°	E32-D73-S 2M	28	14	9	4	5	2.9	1.9	1.3

Area Detection Models

Sensing method	Type	Sensing width	Model	Sensing distance (mm)							
				Reflective: White paper, Through-beam: Opaque object				Reflective: 12-color discrimination, Through-beam: Translucent object *1			
				GIGA	Standard	High-speed	Super-high-speed	GIGA	Standard	High-speed	Super-high-speed *2
Through-beam	Area	11 mm	E32-T16PR 2M	480	250	170	73	96	50	34	21
			E32-T16JR 2M	410	210	140	63	83	43	29	19
		30 mm	E32-T16WR 2M	730	210	140	63	140	43	29	19
Reflective	Array	11 mm	E32-D36P1 2M	75	37	25	11	15	7	5	3.3

Vacuum-resistant Models

Sensing method	Type	Heat-resistant temperature	Model	Sensing distance (mm)							
				Reflective: White paper, Through-beam: Opaque object				Reflective: 12-color discrimination, Through-beam: Translucent object *1			
				GIGA	Standard	High-speed	Super-high-speed	GIGA	Standard	High-speed	Super-high-speed *2
Through-beam	Vacuum side	120°	E32-T51V 1M	110	57	39	16	22	11	7	5
			E32-T51V 1M+E39-F1V	170	90	61	26	34	18	12	7
		200°	E32-T84SV 1M	270	140	97	41	54	28	19	12

*1. These sensing distances are recommended to make the most of the detection capabilities of the Sensor.

*2. The Super-high-speed Mode for 12-color discrimination with a Reflective Sensor or for detection of translucent objects with a Through-beam Sensor can be set only in Contrast Mode. The Super-high-speed Mode can not be set in Color Mode.

Engineering Data (Reference Value)

Color vs. Detection Capability

E3NX-CA□□ + E32-CC200

	White	Red	Yellow/red	Yellow	Yellow/green	Green	Blue/green	Blue	Blue/purple	Purple	Red/purple	Black*
White		○	○	○	○	○	○	○	○	○	○	(○)
Red	○		○	○	○	○	○	○	○	○	○	○
Yellow/red	○	○		○	○	○	○	○	○	○	○	○
Yellow	○	○	○		○	○	○	○	○	○	○	○
Yellow/green	○	○	○	○		○	○	○	○	○	○	○
Green	○	○	○	○	○		○	○	○	○	○	○
Blue/green	○	○	○	○	○	○		○	○	○	○	○
Blue	○	○	○	○	○	○	○		○	○	○	○
Blue/purple	○	○	○	○	○	○	○	○		○	○	○
Purple	○	○	○	○	○	○	○	○	○		○	○
Red/purple	○	○	○	○	○	○	○	○	○	○		○
Black*	(○)	○	○	○	○	○	○	○	○	○	○	

High-speed Mode
 Sensing distance: 10 mm (i.e., tuning distance)
 ○: Detection possible, ×: Detection not possible.
 * Use Contrast Mode to distinguish between white and black.

Correlation vs. Distance

E3NX-CA + E32-CC200

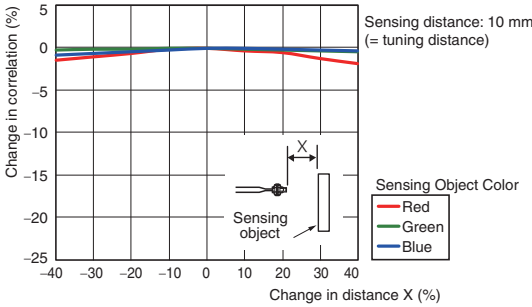

Correlation vs. Angle

E3NX-CA + E32-CC200

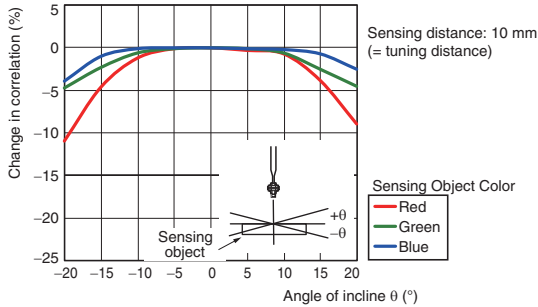

Spot Diameter vs. Sensing Distance

E3NX-CA + E32-L15

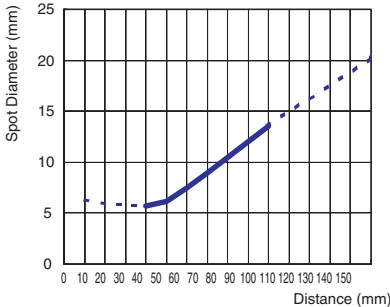

E3NX-CA

I/O Circuit Diagrams

NPN Output

Model	Operation mode	Timing chart	NO/NC indicator	Output circuit
E3NX-CA11 E3NX-CA21 E3NX-CA6	NO (Light-ON)	Incident light: ON No incident light: OFF Operation indicator (orange): ON OFF Output transistor: ON OFF Load: Operate (e.g., relay) Reset (Between brown and black)	NO ON	
	NC (Dark-ON)	Incident light: ON No incident light: OFF Operation indicator (orange): ON OFF Output transistor: ON OFF Load: Operate (e.g., relay) Reset (Between brown and black)	NC ON	

* The CA11 and CA6 have only control output 1. These models do not have control output 2 or an external input, so they do not have the OUT2 indicator.

PNP Output

Model	Operation mode	Timing chart	NO/NC indicator	Output circuit
E3NX-CA41 E3NX-CA51 E3NX-CA8	NO (Light-ON)	Incident light: ON No incident light: OFF Operation indicator (orange): ON OFF Output transistor: ON OFF Load: Operate (e.g., relay) Reset (Between blue and black)	NO ON	
	NC (Dark-ON)	Incident light: ON No incident light: OFF Operation indicator (orange): ON OFF Output transistor: ON OFF Load: Operate (e.g., relay) Reset (Between blue and black)	NC ON	

* The CA41 and CA8 have only control output 1. These models do not have control output 2 or an external input, so they do not have the OUT2 indicator.

Note: 1. Timing Charts for Timer Function Settings (T: Set Time)

ON-delay Timer	OFF-delay Timer	One-shot Timer	ON/OFF-delay Timer
Delays the output ON after detection.	Holds the output ON for detection by PLC when the detection time is too short.	Keeps the output ON for a specified time regardless of the workpiece size variations.	Sets both OFF-delay Timer and ON-delay Timer.

2. Timing Chart for Control Output (AND or OR) (T: Set Time)

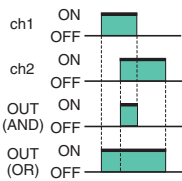

Nomenclature

Standard Models

E3NX-CA11/CA41/CA6/CA8

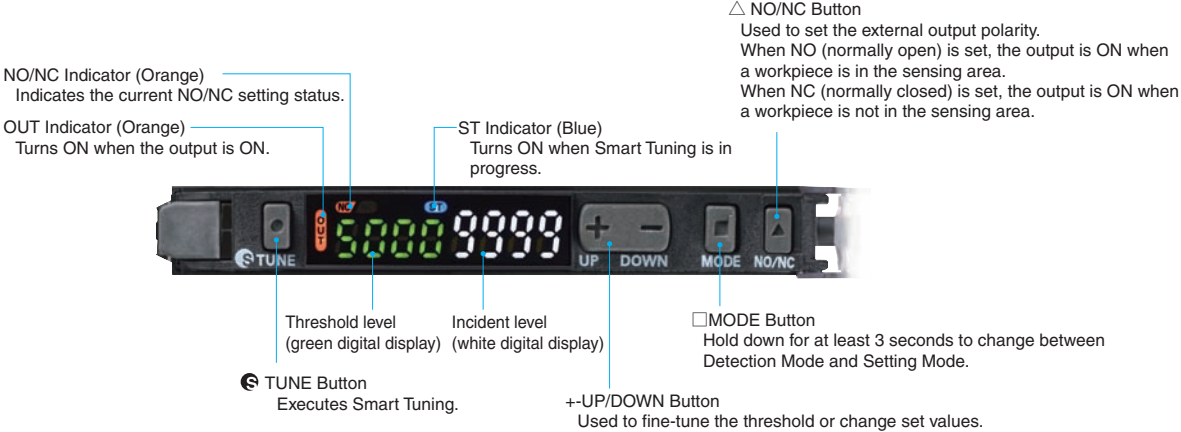

Advanced Models and Model for Sensor Communications Unit

E3NX-CA21/CA51/CA0

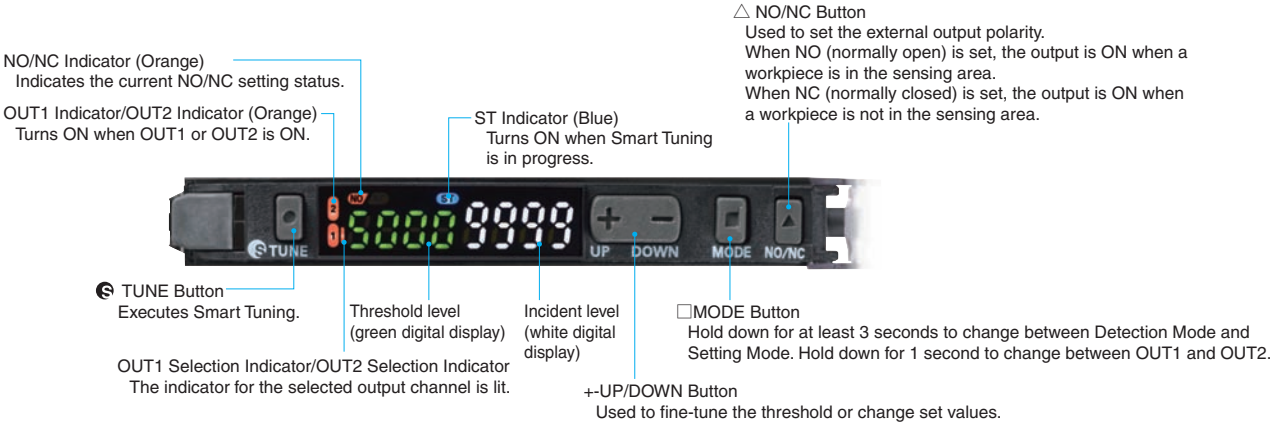



Safety Precautions

Be sure to read the precautions for all models in the website at: <http://www.ia.omron.com/>.

Warning Indications

 WARNING	Warning level Indicates a potentially hazardous situation which, if not avoided, will result in minor or moderate injury, or may result in serious injury or death. Additionally, there may be significant property damage.
Precautions for Safe Use	Supplementary comments on what to do or avoid doing, to use the product safely.
Precautions for Correct Use	Supplementary comments on what to do or avoid doing, to prevent failure to operate, malfunction or undesirable effect on product performance.

Meaning of Product Safety Symbols

	General prohibition Indicates the instructions of unspecified prohibited action.
	Caution, explosion Indicates the possibility of explosion under specific conditions.
	Caution, fire Indicates the possibility of fire under specific conditions.

WARNING

This product is not designed or rated for ensuring safety of persons either directly or indirectly. Do not use it for such purposes. 

Do not use the product with voltage in excess of the rated voltage. Excess voltage may result in malfunction or fire. 

Never use the product with an AC power supply. Otherwise, explosion may result. 

Precautions for Safe Use

The following precautions must be observed to ensure safe operation of the product. Doing so may cause damage or fire.

1. Do not install the product in the following locations.
 - Locations subject to direct sunlight
 - Locations subject to condensation due to high humidity
 - Locations subject to corrosive gas
 - Locations subject to vibration or mechanical shocks exceeding the rated values
 - Locations subject to exposure to water, oil, chemicals
 - Locations subject to steam
 - Locations subject to strong magnetic field or electric field
2. Do not use the product in environments subject to flammable or explosive gases.
3. Do not use the product in any atmosphere or environment that exceeds the ratings.
4. To secure the safety of operation and maintenance, do not install the product close to high-voltage devices and power devices.
5. High-Voltage lines and power lines must be wired separately from this product. Wiring them together or placing them in the same duct may cause induction, resulting in malfunction or damage.
6. Do not apply any load exceeding the ratings. Otherwise damage or fire may result.
7. Do not short the load. Otherwise damage or fire may result.
8. Connect the load correctly.
9. Do not miswire such as the polarity of the power supply.

10. To use this device as connecting with each other, be sure to connect with the same power supply and turn ON the power simultaneously. Using a separate power supply will influence the functions when connecting the devices to use them.
11. Do not use the product if the case is damaged.
12. Burn injury may occur. The product surface temperature rises depending on application conditions, such as the ambient temperature and the power supply voltage. Attention must be paid during operation or cleaning.
13. When setting the sensor, be sure to check safety such as by stopping the equipment.
14. Be sure to turn off the power supply before connecting or disconnecting wires.
15. Do not attempt to disassemble, repair, or modify the product in any way.
16. When disposing of the product, treat it as industrial waste.
17. Do not use the Sensor in water, rain, or outdoors.
18. UL Standard Certification
Only the Sensors with the Enhanced UL Certification Mark are certified by UL. They are intended to be supplied by a "Class 2 circuit". When used in United States and Canada, please use the same Class 2 source for input and output. The overcurrent protection current rating is 2 A max. They were evaluated as Open type and shall be installed within a enclosure.

Precautions for Correct Use

1. Be sure to mount the unit to the DIN track until it clicks.
2. When using the Amplifier Units with Wire-saving Connectors, attach the protective stickers (provided with E3X-CN-series Connectors) on the unused power pins to prevent electrical shock and short circuiting. When using Amplifier Units with Connectors for Communications Units, attach the protective caps (provided with E3NW-series Sensor Communications Units).

Amplifier Unit with Wire-saving Connector

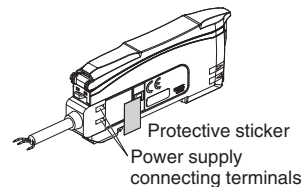

Amplifier Unit with Connector for Communications Unit

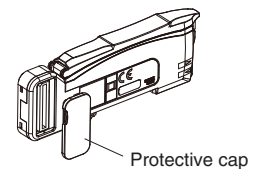

3. Use an extension cable with a maximum length of 30 m. Be sure to use a cable of at least 0.3 mm² for extension. The power voltage must be 24 to 30 V when connecting Amplifier Units with extension cable and wire-saving connector.
4. Do not apply the forces on the cable exceeding the following limits:
Pull: 40 N; torque: 0.1 N·m; pressure: 20 N; bending: 29.4 N
5. Use the E32-□□ Fiber Unit.
6. Do not apply excessive force such as tension, compression or torsion to the Fiber Amplifier Unit with the Fiber Unit fixed to the Fiber Amplifier Unit.
7. Always keep the protective cover in place when using the product. Not doing so may cause malfunction.
8. It may take time until the incident level and measurement value become stable immediately after the power is turned on depending on use environment.
9. The product is ready to operate 200 ms after the power supply is turned ON.
10. The Mobile Console E3X-MC11, E3X-MC11-SV2 and E3X-MC11-S cannot be connected.
11. The mutual interference prevention function does not work when in combination with E3C/E2C/E3X.
12. Excessive incident light cannot be sufficiently handled by the mutual interference prevention function and may cause malfunction. To prevent this, set a higher threshold level.
13. The Communication Unit E3X-DRT21-S, E3X-CRT, E3X-ECT and E3NW cannot be connected.
14. If you notice an abnormal condition such as a strange odor, extreme heating of the unit, or smoke, immediately stop using the product, turn off the power, and consult your dealer.
15. Do not use thinner, benzene, acetone, and lamp oil for cleaning.

Dimensions

Fiber Amplifier Units

Pre-wired Amplifier Units

- E3NX-CA11
- E3NX-CA41
- E3NX-CA21
- E3NX-CA51

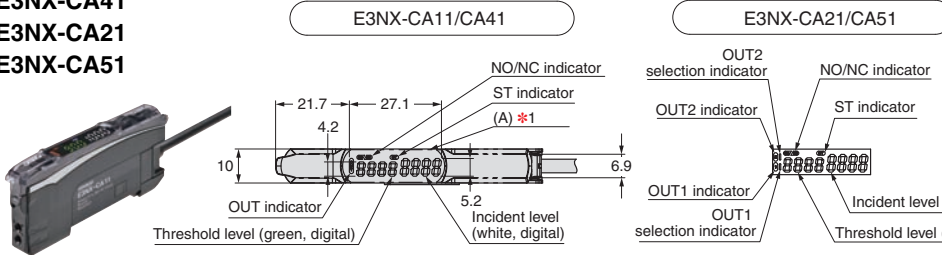

*1. The Mounting Bracket can also be used on side A.
*2. Cable Specifications

Model	Outer diameter	No. of conductors	Others
E3NX-CA11	4.0 dia.	3	Conductor cross-section: 0.2 mm ² Insulator dia.: 0.9 mm
E3NX-CA41		3	
E3NX-CA21	4.0 dia.	5	Conductor cross-section: 0.2 mm ² Insulator dia.: 0.9 mm
E3NX-CA51		5	

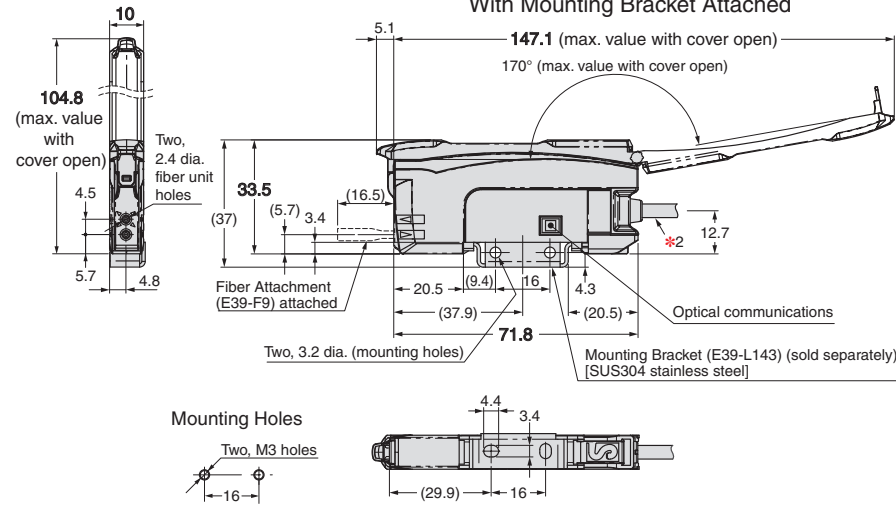

Standalone Product Diagram

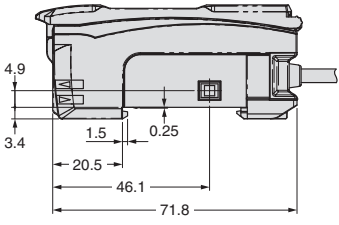

Amplifier Units with Wire-saving Connectors

- E3NX-CA6
- E3NX-CA8

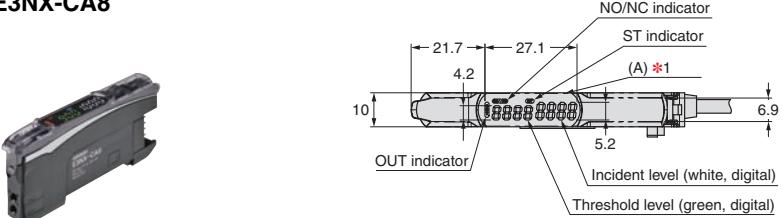

*1. The Mounting Bracket can also be used on side A.
*2. Cable Specifications

Model	Outer diameter	No. of conductors
E3X-CN12	2.6 dia.	1
E3X-CN22	4.0 dia.	2
E3X-CN11		3

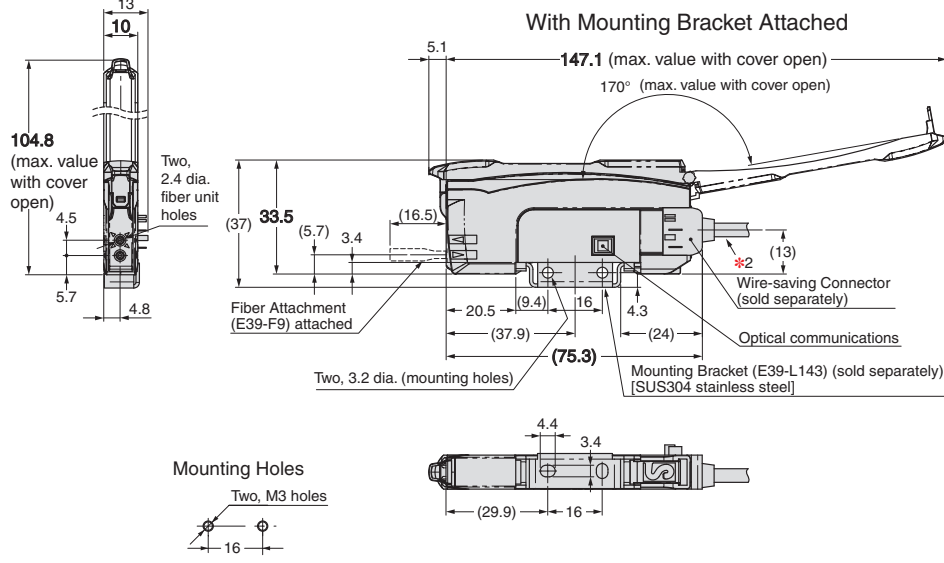

Standalone Product Diagram

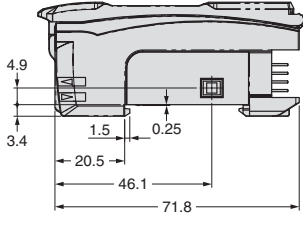

E3NX-CA

Amplifier Unit with Connector for Sensor Communications Unit E3NX-CA0

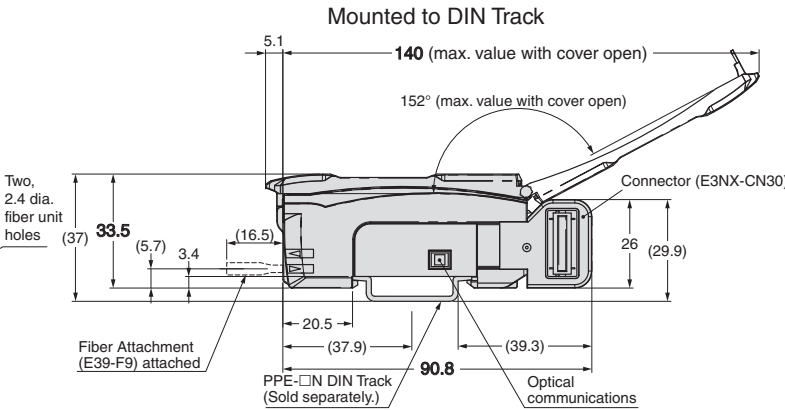
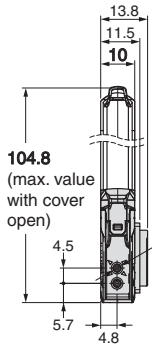
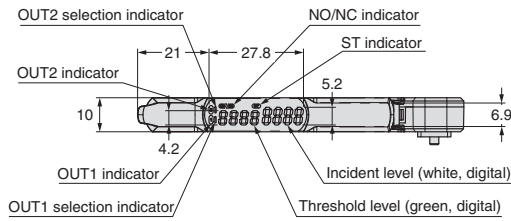

Standalone Product Diagram

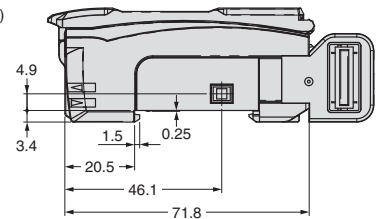

Fiber Units

Reflective Models E32-C91N

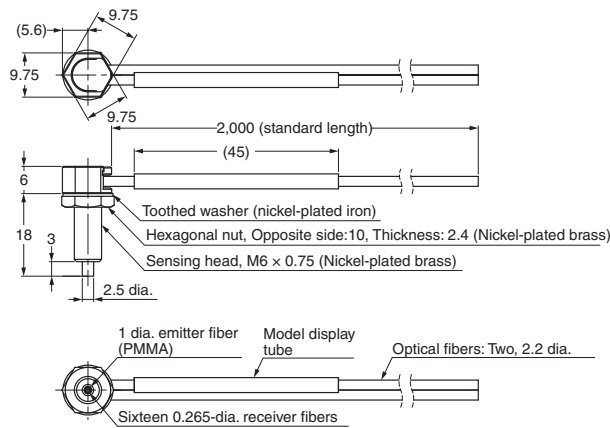

Through-beam Models (Grooved Type) E32-G16

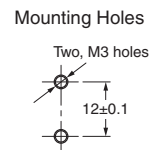
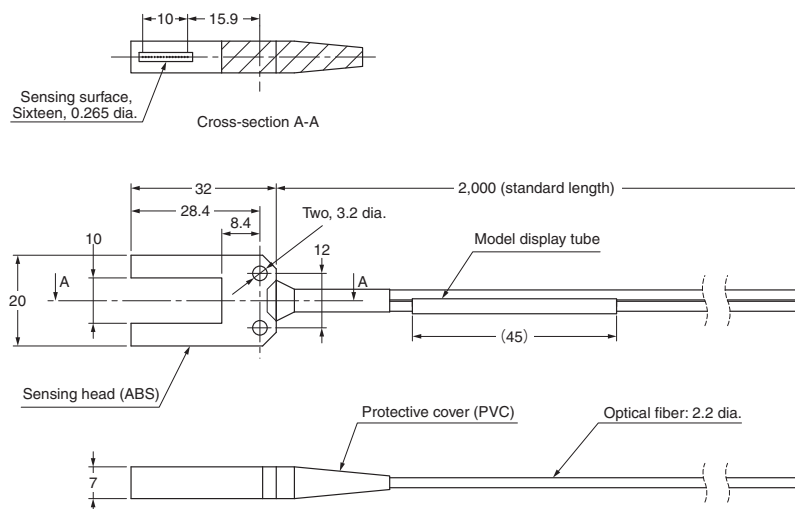

Accessories (Sold Separately)

Wire-saving Connectors

Master Connector E3X-CN11

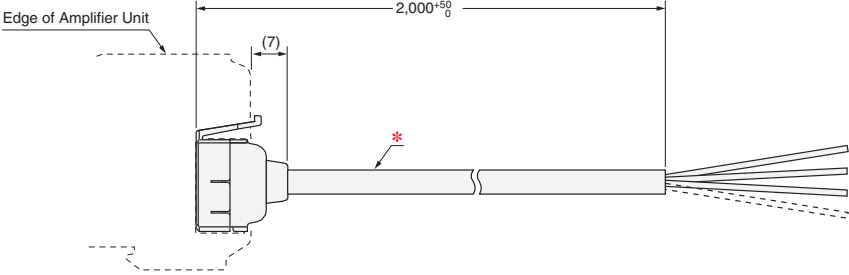

* 4-dia. cable with 3 conductors, Standard cable length: 2 m (Conductor cross-section: 0.2 mm² (AWG24), Insulator diameter: 1.1 mm)

Slave Connector E3X-CN12

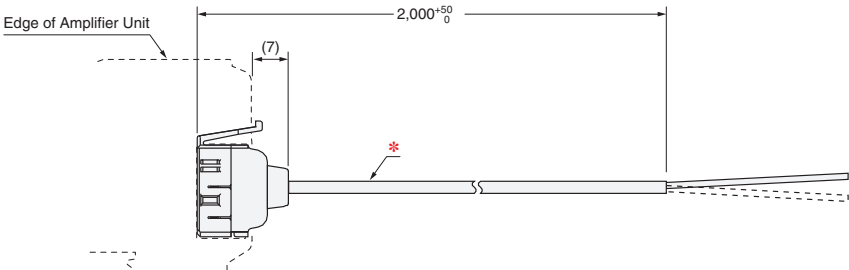

* 2.6-dia. cable with 1 conductor, Standard cable length: 2 m (Conductor cross-section: 0.2 mm² (AWG24), Insulator diameter: 1.1 mm)

Mounting Bracket E39-L143

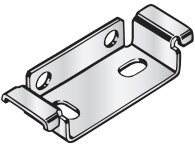

Material: Stainless steel (SUS304)

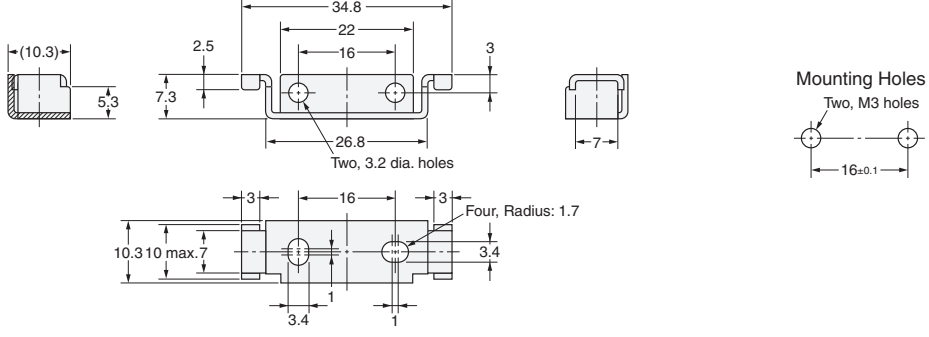

E3NX-CA

DIN Tracks

PFP-100N

PFP-50N

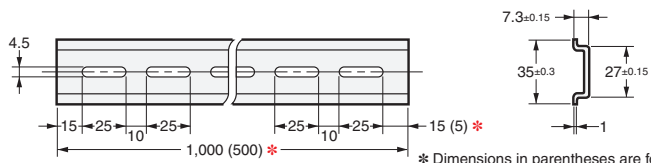

* Dimensions in parentheses are for the PFP-50N.

Material: Aluminum

PFP-100N2

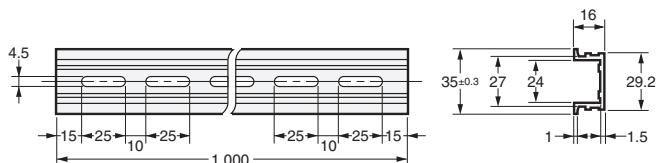

Material: Aluminum

End Plate

PFP-M

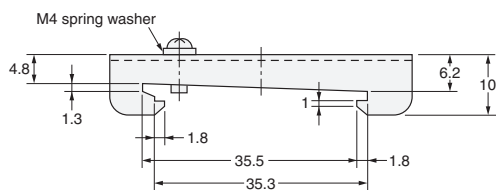
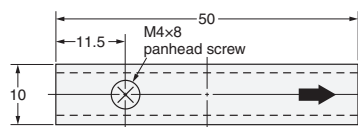
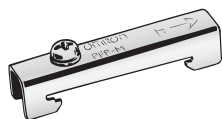

Materials: Iron, zinc plating

Terms and Conditions Agreement

Read and understand this catalog.

Please read and understand this catalog before purchasing the products. Please consult your OMRON representative if you have any questions or comments.

Warranties.

(a) Exclusive Warranty. Omron's exclusive warranty is that the Products will be free from defects in materials and workmanship for a period of twelve months from the date of sale by Omron (or such other period expressed in writing by Omron). Omron disclaims all other warranties, express or implied.

(b) Limitations. OMRON MAKES NO WARRANTY OR REPRESENTATION, EXPRESS OR IMPLIED, ABOUT NON-INFRINGEMENT, MERCHANTABILITY OR FITNESS FOR A PARTICULAR PURPOSE OF THE PRODUCTS. BUYER ACKNOWLEDGES THAT IT ALONE HAS DETERMINED THAT THE PRODUCTS WILL SUITABLY MEET THE REQUIREMENTS OF THEIR INTENDED USE.

Omron further disclaims all warranties and responsibility of any type for claims or expenses based on infringement by the Products or otherwise of any intellectual property right. (c) Buyer Remedy. Omron's sole obligation hereunder shall be, at Omron's election, to (i) replace (in the form originally shipped with Buyer responsible for labor charges for removal or replacement thereof) the non-complying Product, (ii) repair the non-complying Product, or (iii) repay or credit Buyer an amount equal to the purchase price of the non-complying Product; provided that in no event shall Omron be responsible for warranty, repair, indemnity or any other claims or expenses regarding the Products unless Omron's analysis confirms that the Products were properly handled, stored, installed and maintained and not subject to contamination, abuse, misuse or inappropriate modification. Return of any Products by Buyer must be approved in writing by Omron before shipment. Omron Companies shall not be liable for the suitability or unsuitability or the results from the use of Products in combination with any electrical or electronic components, circuits, system assemblies or any other materials or substances or environments. Any advice, recommendations or information given orally or in writing, are not to be construed as an amendment or addition to the above warranty.

See <http://www.omron.com/global/> or contact your Omron representative for published information.

Limitation on Liability; Etc.

OMRON COMPANIES SHALL NOT BE LIABLE FOR SPECIAL, INDIRECT, INCIDENTAL, OR CONSEQUENTIAL DAMAGES, LOSS OF PROFITS OR PRODUCTION OR COMMERCIAL LOSS IN ANY WAY CONNECTED WITH THE PRODUCTS, WHETHER SUCH CLAIM IS BASED IN CONTRACT, WARRANTY, NEGLIGENCE OR STRICT LIABILITY.

Further, in no event shall liability of Omron Companies exceed the individual price of the Product on which liability is asserted.

Suitability of Use.

Omron Companies shall not be responsible for conformity with any standards, codes or regulations which apply to the combination of the Product in the Buyer's application or use of the Product. At Buyer's request, Omron will provide applicable third party certification documents identifying ratings and limitations of use which apply to the Product. This information by itself is not sufficient for a complete determination of the suitability of the Product in combination with the end product, machine, system, or other application or use. Buyer shall be solely responsible for determining appropriateness of the particular Product with respect to Buyer's application, product or system. Buyer shall take application responsibility in all cases.

NEVER USE THE PRODUCT FOR AN APPLICATION INVOLVING SERIOUS RISK TO LIFE OR PROPERTY OR IN LARGE QUANTITIES WITHOUT ENSURING THAT THE SYSTEM AS A WHOLE HAS BEEN DESIGNED TO ADDRESS THE RISKS, AND THAT THE OMRON PRODUCT(S) IS PROPERLY RATED AND INSTALLED FOR THE INTENDED USE WITHIN THE OVERALL EQUIPMENT OR SYSTEM.

Programmable Products.

Omron Companies shall not be responsible for the user's programming of a programmable Product, or any consequence thereof.

Performance Data.

Data presented in Omron Company websites, catalogs and other materials is provided as a guide for the user in determining suitability and does not constitute a warranty. It may represent the result of Omron's test conditions, and the user must correlate it to actual application requirements. Actual performance is subject to the Omron's Warranty and Limitations of Liability.

Change in Specifications.

Product specifications and accessories may be changed at any time based on improvements and other reasons. It is our practice to change part numbers when published ratings or features are changed, or when significant construction changes are made. However, some specifications of the Product may be changed without any notice. When in doubt, special part numbers may be assigned to fix or establish key specifications for your application. Please consult with your Omron's representative at any time to confirm actual specifications of purchased Product.

Errors and Omissions.

Information presented by Omron Companies has been checked and is believed to be accurate; however, no responsibility is assumed for clerical, typographical or proofreading errors or omissions.



EtherCAT® is a registered trademark and patented technology, licensed by Beckhoff Automation GmbH, Germany.

The product photographs and figures that are used in this catalog may vary somewhat from the actual products.

OMRON Corporation Industrial Automation Company

Kyoto, JAPAN

Contact: www.ia.omron.com

Regional Headquarters

OMRON EUROPE B.V.

Sensor Business Unit

Carl-Benz-Str. 4, D-71154 Nufringen, Germany
Tel: (49) 7032-811-0/Fax: (49) 7032-811-199

OMRON ELECTRONICS LLC

2895 Greenspoint Parkway, Suite 200
Hoffman Estates, IL 60169 U.S.A.
Tel: (1) 847-843-7900/Fax: (1) 847-843-7787

OMRON ASIA PACIFIC PTE. LTD.

No. 438A Alexandra Road # 05-05/08 (Lobby 2),
Alexandra Technopark,
Singapore 119967
Tel: (65) 6835-3011/Fax: (65) 6835-2711

OMRON (CHINA) CO., LTD.

Room 2211, Bank of China Tower,
200 Yin Cheng Zhong Road,
PuDong New Area, Shanghai, 200120, China
Tel: (86) 21-5037-2222/Fax: (86) 21-5037-2200

Authorized Distributor:

© OMRON Corporation 2016 All Rights Reserved.
In the interest of product improvement,
specifications are subject to change without notice.

CSM_1_7_0519
Cat. No. Y216-E1-01

0516 (0516)

Mouser Electronics

Authorized Distributor

Click to View Pricing, Inventory, Delivery & Lifecycle Information:

[Omron:](#)

[E3S-DCN21](#)

Данный компонент на территории Российской Федерации

Вы можете приобрести в компании MosChip.

Для оперативного оформления запроса Вам необходимо перейти по данной ссылке:

<http://moschip.ru/get-element>

Вы можете разместить у нас заказ для любого Вашего проекта, будь то серийное производство или разработка единичного прибора.

В нашем ассортименте представлены ведущие мировые производители активных и пассивных электронных компонентов.

Нашей специализацией является поставка электронной компонентной базы двойного назначения, продукции таких производителей как XILINX, Intel (ex.ALTERA), Vicor, Microchip, Texas Instruments, Analog Devices, Mini-Circuits, Amphenol, Glenair.

Сотрудничество с глобальными дистрибьюторами электронных компонентов, предоставляет возможность заказывать и получать с международных складов практически любой перечень компонентов в оптимальные для Вас сроки.

На всех этапах разработки и производства наши партнеры могут получить квалифицированную поддержку опытных инженеров.

Система менеджмента качества компании отвечает требованиям в соответствии с ГОСТ Р ИСО 9001, ГОСТ РВ 0015-002 и ЭС РД 009

Офис по работе с юридическими лицами:

105318, г.Москва, ул.Щербаковская д.3, офис 1107, 1118, ДЦ «Щербаковский»

Телефон: +7 495 668-12-70 (многоканальный)

Факс: +7 495 668-12-70 (доб.304)

E-mail: info@moschip.ru

Skype отдела продаж:

moschip.ru

moschip.ru_4

moschip.ru_6

moschip.ru_9