



Micro ISO  
1 Form C type



Micro ISO  
1 Form A type

RoHS compliant

### FEATURES

- **Low profile:**  
22.5 mm(L)×15 mm(W)×15.7 mm(H)  
.886 inch(L)×.591 inch(W)×.618 inch(H)
- **Low temperature rise**  
Terminal temperature has been reduced compared with using our conventional product
- **Low sound pressure level**  
Noise level has been reduced approx. 10dB compared with using our conventional product.
- **Wide line-up**  
Micro ISO terminal types and resistor inside type.
- **Plastic sealed type**  
Plastically sealed for automatic cleaning.
- **Compact and high-capacity 20A load switching**  
N.O.: 20A 14V DC, N.C.: 10A 14V DC  
(Max. carrying current: at 85°C 185°F)

### TYPICAL APPLICATIONS

- Headlights
- Magnetic clutches
- Radiator fans
- Blowers
- Fog lamps
- Tail lights
- Heaters
- Defoggers
- Horns
- Condenser fans, etc.

### ORDERING INFORMATION

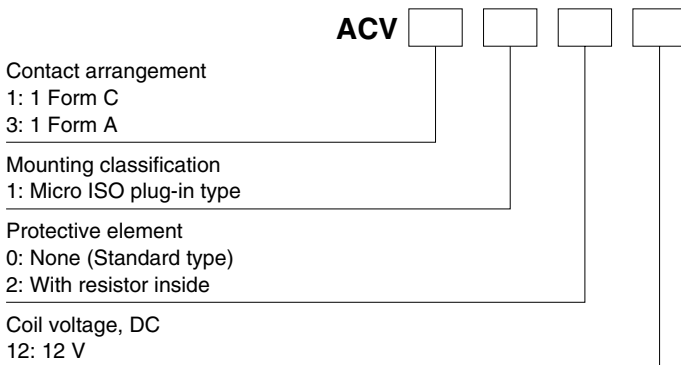

### TYPES

| Contact arrangement | Coil voltage | Protective construction | Mounting classification | Part No. |
|---------------------|--------------|-------------------------|-------------------------|----------|
| 1 Form A            | 12 V DC      | Sealed type             | Micro ISO plug-in type  | ACV31012 |
| 1 Form C            |              |                         | Micro ISO plug-in type  | ACV11012 |

Note: Please use "ACV\*\*212" to order built-in resistor type. (Asterisks " \* " should be filled in from ORDERING INFORMATION.)  
Standard packing: Carton: 50 pcs.; Case: 200 pcs.

### RATING

#### 1. Coil data

| Nominal coil voltage | Pick-up voltage*<br>(at 20°C 68°F) | Drop-out voltage<br>(at 20°C 68°F) | Nominal operating current<br>[±10%] (at 20°C 68°F) | Coil resistance<br>[±10%] (at 20°C 68°F) | Nominal operating power<br>(at 20°C 68°F) | Usable voltage range<br>(at 85°C 185°F) |
|----------------------|------------------------------------|------------------------------------|--|--|---|---|
| 12V DC               | Max. 7.0 V DC<br>(Initial)         | Min. 0.6 V DC<br>(Initial)         | 67 mA,<br>84 mA (with resistor)                    | 180Ω,<br>142.3Ω (with resistor)          | 0.8 W,<br>1.0 W (with resistor)           | 10 to 16V DC                            |

Note: \* Other pick-up voltage types are also available. Please contact us for details.

## 2. Specifications

| Characteristics            | Item  | Specifications  |  |
|----------------------------|---|---|--|
|                            |   | 1 Form A  | 1 Form C   |
| Contact                    | Arrangement                                       | Typ 3mΩ (By voltage drop 6V DC 1A)  |  |
|                            | Contact resistance (Initial)                      | N.O.: Max. 0.2 V (By voltage drop 14 V DC 20 A)<br>N.C.: Max. 0.5 V (By voltage drop 14 V DC 10 A)  |  |
|                            | Contact voltage drop (after electrical life test) | Ag alloy (Cadmium free)   |  |
|                            | Contact material                                  | N.O.: 20 A 14V DC<br>N.C.: 20 A 14V DC, N.C.: 10 A 14V DC   |  |
| Rating                     | Nominal switching capacity (resistive load)       | 0.8 W, 1.0 W (built-in resistor type)   |  |
|                            | Max. carrying current (at 85°C 185°F, continuous) | 1 A 12V DC  |  |
|                            | Nominal operating power                           | N.O.: 20 A 14V DC<br>N.C.: 20 A 14V DC<br>N.C.: 10 A 14V DC   |  |
|                            | Min. switching capacity (resistive load)*1        | N.O.: 20 A 14V DC   |  |
| Electrical characteristics | Insulation resistance (Initial)                   | Min. 20 MΩ (at 500V DC)   |  |
|                            | Breakdown voltage (Initial)                       | Between open contacts   | 500 Vrms for 1 min. (Detection current: 10mA)  |
|                            |   | Between contacts and coil   | 500 Vrms for 1 min. (Detection current: 10mA)  |
|                            | Operate time (at nominal voltage) (at 20°C 68°F)  | Max. 10ms (excluding contact bounce time) (Initial)   |  |
|                            | Release time (at nominal voltage) (at 20°C 68°F)  | Max. 10ms (excluding contact bounce time) (Initial)   |  |
| Mechanical characteristics | Shock resistance                                  | Functional  | Min. 100 m/s <sup>2</sup> {10G} (Half-wave pulse of sine wave: 11ms; detection time: 10μs)                           |
|                            |   | Destructive   | Min. 1,000 m/s <sup>2</sup> {100G} (Half-wave pulse of sine wave: 6ms)   |
|                            | Vibration resistance                              | Functional  | 10 Hz to 100 Hz, Min. 44.1 m/s <sup>2</sup> {4.5G} (Detection time: 10μs)  |
|                            |   | Destructive   | 10 Hz to 500 Hz, Min. 44.1 m/s <sup>2</sup> {4.5G}, Time of vibration for each direction; X, Y, Z direction: 4 hours |
| Expected life              | Mechanical  | Min. 10 <sup>6</sup> (at 120 cpm)   |  |
|                            | Electrical (at nominal switching capacity)        | Min. 10 <sup>5</sup> (operating frequency: 2s ON, 2s OFF)   |  |
| Conditions                 | Conditions for operation, transport and storage*2 | Ambient temperature: -40°C to +85°C -40°F to +185°F*3,<br>Humidity: 5% R.H. to 85% R.H. (Not freezing and condensing at low temperature),<br>air pressure: 86 to 106kPa |  |
| Mass                       |   | Approx. 15 g .53 oz   |  |

Notes: \*1. This value can change due to the switching frequency, environmental conditions, and desired reliability level, therefore it is recommended to check this with the actual load.

\*2. The upper operation ambient temperature limit is the maximum temperature that can satisfy the coil temperature rise value. Please refer to "Usage ambient condition" in CAUTIONS FOR USE OF AUTOMOTIVE RELAYS.

\*3. Please inquire if you will be using the relay in a high temperature atmosphere.

\* Regarding solder, this product is not MIL (Military Standard) compliant. Please evaluate solder mounting by the actual equipment before using.

## REFERENCE DATA

### 1. Coil temperature rise (20A)

Point measured: Inside the coil  
Contact carrying current: 20A  
Coil applied voltage: 13.5V

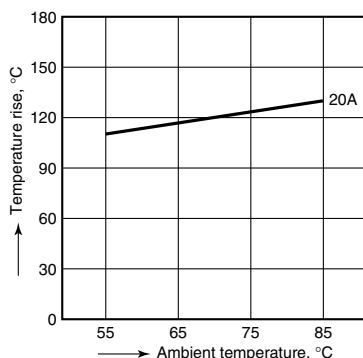

### 2. Distribution of pick-up and drop-out voltage

Sample: ACV11012, 100pcs

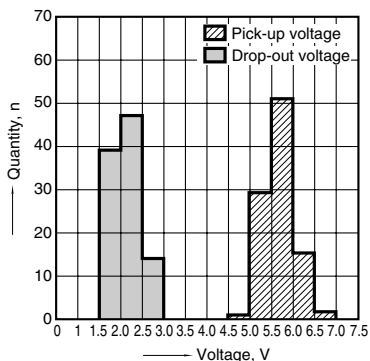

### 3. Distribution of operate and release time

Sample: ACV11012, 100pcs.

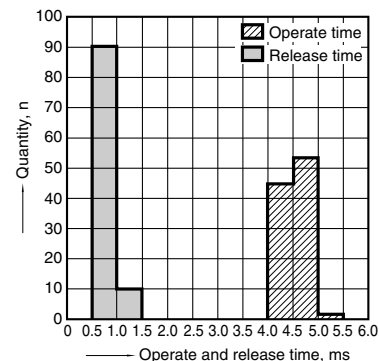

### 4. Ambient temperature and operating voltage range

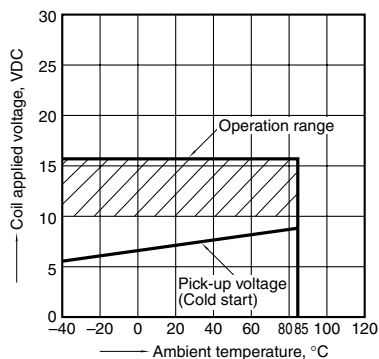

# CV (ACV)

## 5-(1). Electrical life test (Resistive load)

Sample: ACV11012, 3pcs.  
 Load: Resistive load (NC switching) 10A  
 Switching frequency: ON 1s, OFF 1s  
 Ambient temperature: Room temperature

### Circuit

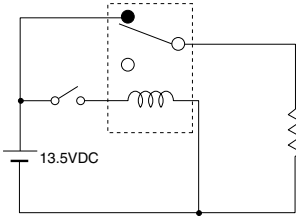

### Change of pick-up and drop-out voltage

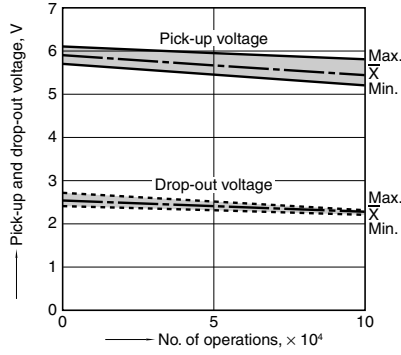

### Change of contact resistance

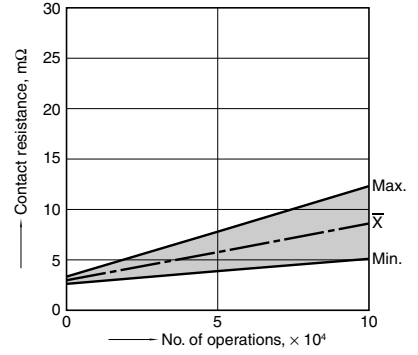

### Load current waveform

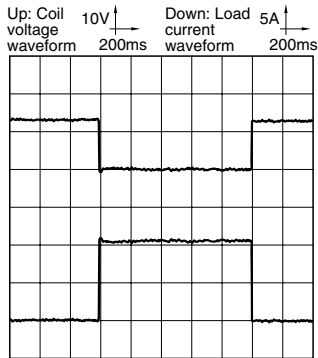

## 5-(2). Electrical life test (Lamp load)

Sample: ACV31212, 3pcs.  
 Load: 55Wx4, inrush: 90A/steady: 20A,  
 lamp actual load  
 Switching frequency: ON 1s, OFF 14s  
 Ambient temperature: Room temperature

### Circuit

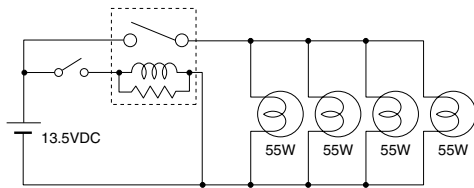

### Change of pick-up and drop-out voltage

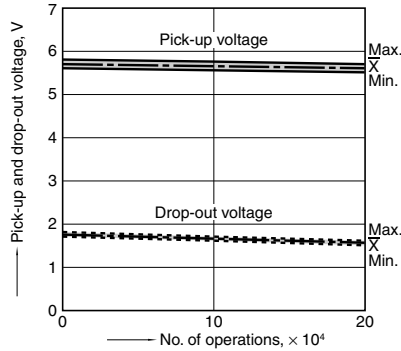

### Change of contact resistance

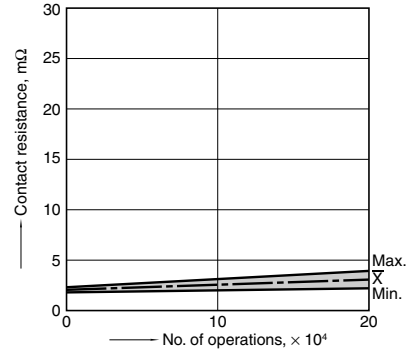

### Load current waveform

Inrush current: 90A, steady current: 20A

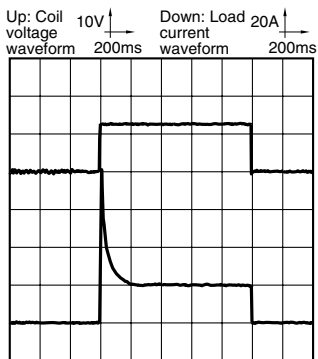

## 5-(3). Electrical life test (Motor load)

Sample: ACV31212, 3pcs.  
 Load: inrush: 80A/steady: 18A,  
 radiator fan actual load (motor free)  
 Switching frequency: ON 2s, OFF 6s  
 Ambient temperature: Room temperature

### Circuit

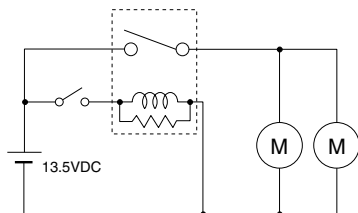

### Change of pick-up and drop-out voltage

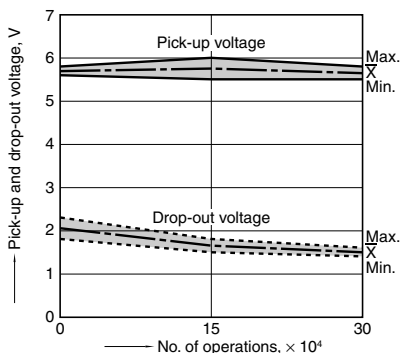

### Change of contact resistance

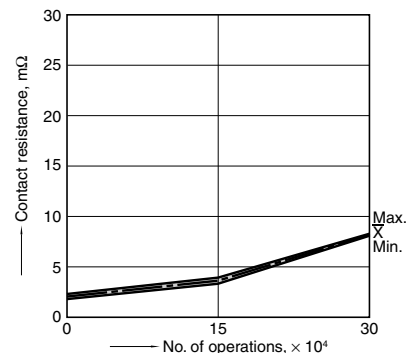

### Load current waveform

Inrush current: 80A, steady current: 18A

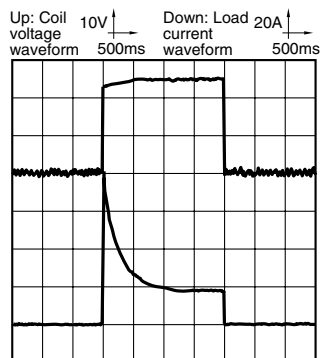

## DIMENSIONS (mm inch)

The CAD data of the products with a **CAD Data** mark can be downloaded from: <http://industrial.panasonic.com/ac/e/>

### 1. Micro ISO plug-in type

**CAD Data**



#### External dimensions

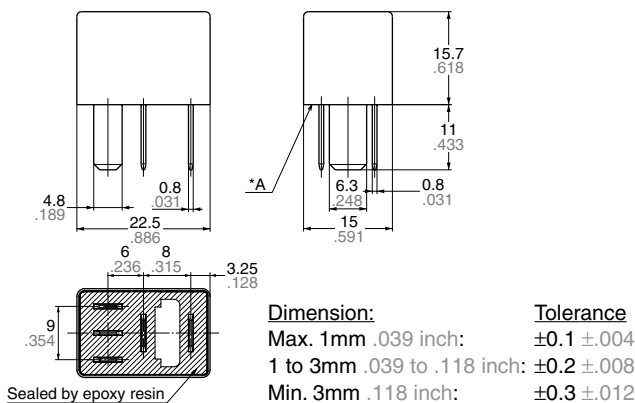

#### Schematic (Bottom view)

##### 1 Form A

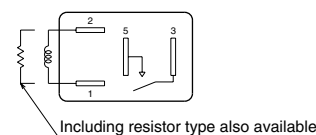

##### 1 Form C

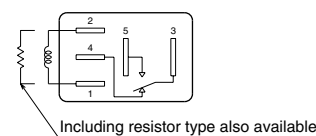

Note: Intervals between terminals is measured at A surface level.

**For Cautions for Use, see Relay Technical Information.**

# Mouser Electronics

Authorized Distributor

Click to View Pricing, Inventory, Delivery & Lifecycle Information:

[Panasonic:](#)

[ACV31024](#) [ACV31124](#) [ACV11024](#) [ACV31224](#)

## Данный компонент на территории Российской Федерации

### Вы можете приобрести в компании MosChip.

Для оперативного оформления запроса Вам необходимо перейти по данной ссылке:

<http://moschip.ru/get-element>

Вы можете разместить у нас заказ для любого Вашего проекта, будь то серийное производство или разработка единичного прибора.

В нашем ассортименте представлены ведущие мировые производители активных и пассивных электронных компонентов.

Нашей специализацией является поставка электронной компонентной базы двойного назначения, продукции таких производителей как XILINX, Intel (ex.ALTERA), Vicor, Microchip, Texas Instruments, Analog Devices, Mini-Circuits, Amphenol, Glenair.

Сотрудничество с глобальными дистрибьюторами электронных компонентов, предоставляет возможность заказывать и получать с международных складов практически любой перечень компонентов в оптимальные для Вас сроки.

На всех этапах разработки и производства наши партнеры могут получить квалифицированную поддержку опытных инженеров.

Система менеджмента качества компании отвечает требованиям в соответствии с ГОСТ Р ИСО 9001, ГОСТ РВ 0015-002 и ЭС РД 009

### Офис по работе с юридическими лицами:

105318, г.Москва, ул.Щербаковская д.3, офис 1107, 1118, ДЦ «Щербаковский»

Телефон: +7 495 668-12-70 (многоканальный)

Факс: +7 495 668-12-70 (доб.304)

E-mail: [info@moschip.ru](mailto:info@moschip.ru)

Skype отдела продаж:

moschip.ru

moschip.ru\_4

moschip.ru\_6

moschip.ru\_9