

1.224V Open Collector Shunt Voltage Reference

- Internal 1.224V $\pm 0.5\%$ precision
- Low output saturation voltage
75 mV max between SINK and GND
- Low current consumption: 250 μ A
- Industrial temperature range: -40 to +85°C
- 100ppm/°C temperature coefficient

Description

The TS4431 is a four-terminal device dedicated to low voltage Switch Mode Power Supplies (SMPS).

It integrates a 1.224V voltage reference, an amplifier, and an open collector output transistor in a single package. The TS4431's operating mode is similar to the well-known standard voltage reference, the TL431. It maintains the desired feedback voltage at the REF pin in a closed loop configuration by sinking a current proportional to the error voltage at the REF pin.

TS4431 features an open collector transistor with an ultra-low saturation voltage, allowing it to be used in series with the optocoupler in an SMPS architecture to regulate low voltage SMPS.

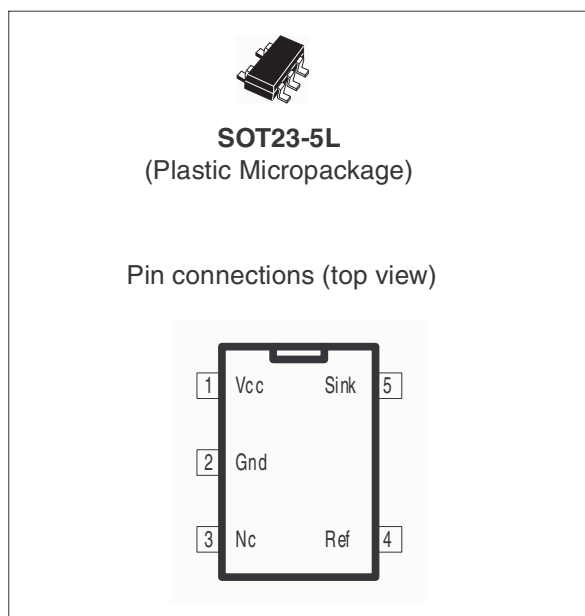

Applications

- Low voltage switch mode power supplies
- Isolated DC/DC converter
- Computers
- Low voltage discrete regulator

Order Codes

| Part Number | Accuracy | Temperature Range | Package | Packing | Marking |
|-------------|----------|-------------------|---------|-------------|---------|
| TS4431AILT | 0.5% | -40, +85°C | SOT23-5 | Tape & Reel | L288 |
| TS4431ILT | 1% | | | | L275 |

1 Absolute Maximum Ratings

Table 1. Key parameters and their absolute maximum ratings

| Symbol | Parameter | Value | Unit |
|------------|--|-------------|------|
| I_{SINK} | Output sink current | 30 | mA |
| V_{CC} | Supply voltage | 12 | V |
| V_{SINK} | Output voltage | 12 | V |
| P_D | Power Dissipation ⁽¹⁾ SOT23-5 | 500 | mW |
| T_{STD} | Storage Temperature | -65 to +150 | °C |
| ESD | Human Body Model (HBM) | 2 | kV |
| | Machine Model (MM) | 200 | V |
| T_{LEAD} | Lead Temperature (soldering, 10 seconds) | 250 | °C |

1. P_D has been calculated with $T_{AMB} = 25^{\circ}\text{C}$, $T_{Junction} = 150^{\circ}\text{C}$ and
 $R_{thJA} = 250^{\circ}\text{C/W}$ for the SOT23-5 package
 $R_{thJC} = 81^{\circ}\text{C/W}$ for the SOT23-5 package

Table 2. Operating conditions

| Symbol | Parameter | Value | Unit |
|------------|-----------------------------|------------|------|
| T_{OPER} | Operating temperature range | -40 to +85 | °C |
| V_{CC} | Supply voltage | 1.5 to 10 | V |
| I_{SINK} | Output sink current | 20 | mA |

2 Typical Application Schematic

Figure 1. SMPS power supply: secondary side

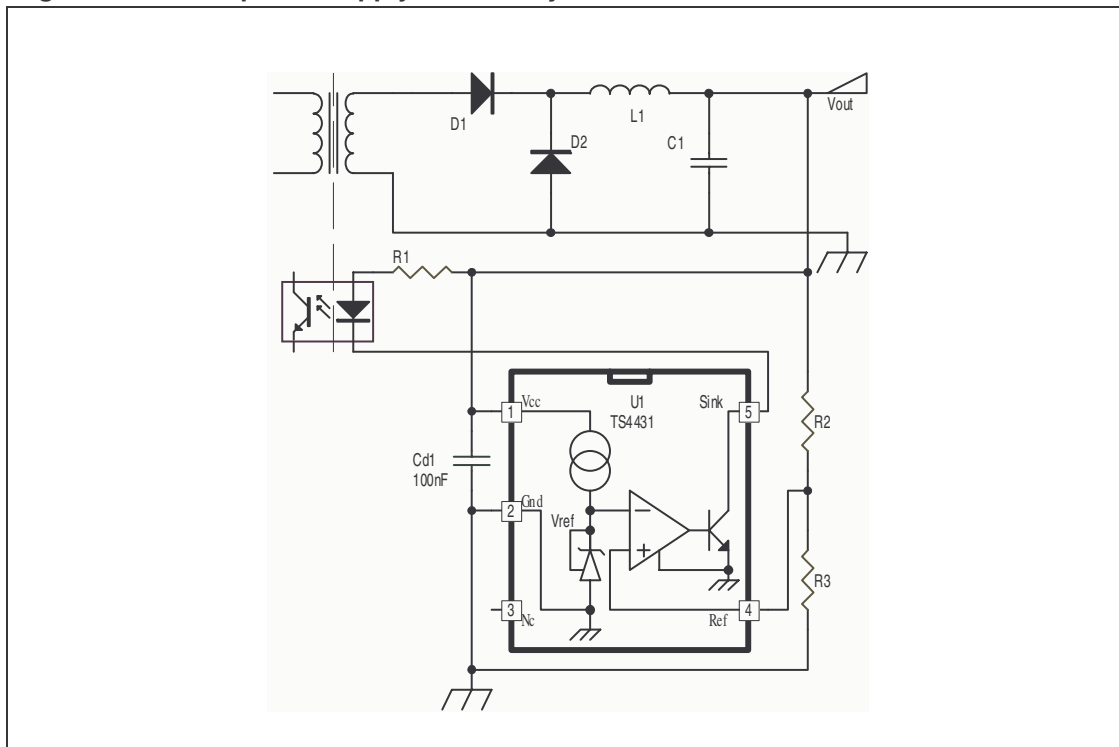

3 Electrical Characteristics

Table 3. Electrical characteristics for $T_{amb} = 25^{\circ}\text{C}$, $V_{CC} = 1.8\text{V}$, $I_{SINK} = 2\text{mA}$ unless otherwise specified

| Symbol | Parameter | Test Condition | Min. | Typ. | Max. | Unit |
|--|---|---|-------|-------|-------|-------------------------|
| V_{REF} | Reference voltage TS4431A 0.5% | | 1.218 | 1.224 | 1.230 | V |
| | | $-40^{\circ}\text{C} < T < +85^{\circ}\text{C}$ | 1.209 | | 1.239 | |
| V_{REF} | Reference voltage TS4431 1% | | 1.212 | 1.224 | 1.236 | V |
| | | $-40^{\circ}\text{C} < T < +85^{\circ}\text{C}$ | 1.203 | | 1.245 | |
| T_C | Temperature coefficient | | | | 100 | ppm/ $^{\circ}\text{C}$ |
| $\frac{\Delta V_{REF}}{\Delta V_{CC}}$ | Change in V_{REF} due to change in V_{CC} | $V_{CC}=1.5$ to 10V | | 1 | 2 | mV |
| | | $-40^{\circ}\text{C} < T < +85^{\circ}\text{C}$ | | 2 | 3 | |
| $\frac{\Delta V_{REF}}{\Delta I_{SINK}}$ | Change in V_{REF} due to change in I_{SINK} | $I_{SINK}=0.5$ to 20mA | | 7 | 10 | mV |
| | | $-40^{\circ}\text{C} < T < +85^{\circ}\text{C}$ | | | 15 | |
| I_{CC} | Supply current | $I_{SINK}=2\text{mA}$ | | 250 | 300 | μA |
| | | $-40^{\circ}\text{C} < T < +85^{\circ}\text{C}$ | | | 350 | |
| I_{OFF} | OFF-State supply current | Ref $< 0.6\text{V}$ | | 15 | 20 | μA |
| | | $-40^{\circ}\text{C} < T < +85^{\circ}\text{C}$ | | | 30 | |
| I_{REF} | Reference input current | $0.1 < I_{SINK} < 10\text{mA}$ | | 0.4 | 1 | μA |
| | | $-40^{\circ}\text{C} < T < +85^{\circ}\text{C}$ | | | 2 | |
| V_{SAT} | Output transistor saturation voltage | $I_{SINK}=5\text{mA}$ | | 30 | 50 | mV |
| | | $-40^{\circ}\text{C} < T < +85^{\circ}\text{C}$ | | | 60 | |
| | | $I_{SINK}=20\text{mA}$ | | 90 | 100 | |
| | | $-40^{\circ}\text{C} < T < +85^{\circ}\text{C}$ | | | 120 | |
| I_{OH} | Output leakage current | $V_{SINK}=V_{CC}$ | | | 0.05 | μA |
| | | $-40^{\circ}\text{C} < T < +85^{\circ}\text{C}$ | | | 0.1 | |

Note: Limits are 100% production tested at 25°C. Limits over temperature are guaranteed through correlation and by design.

Figure 2. Vref vs. temp. Isink=2mA

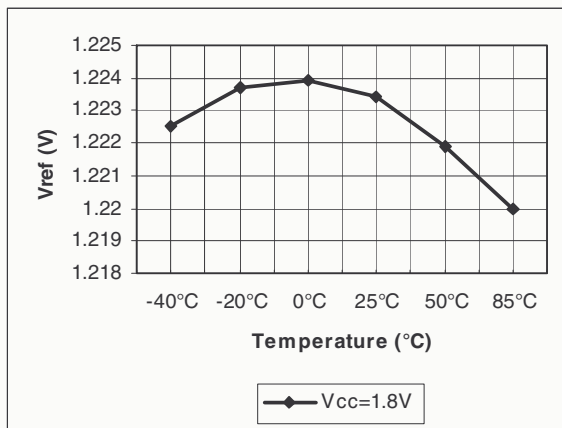

Figure 3. Vref vs. temp. Isink=2mA

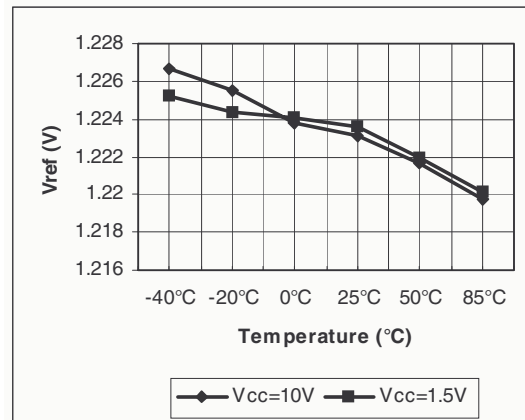

Figure 4. dVref/dVcc vs. temp. Isink=2mA

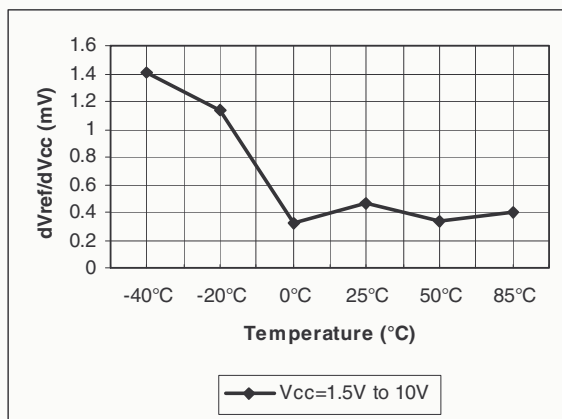

Figure 5. Icc vs. temp. Isink=2mA

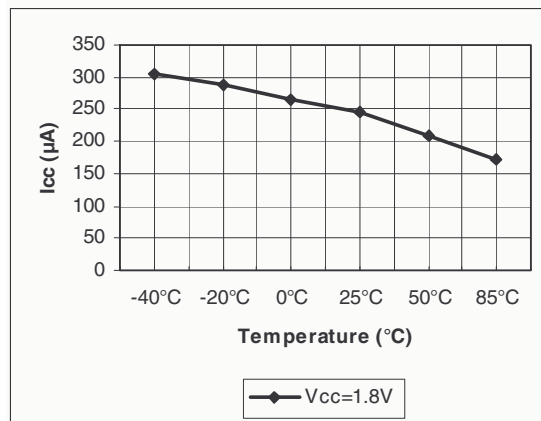

Figure 6. Icc vs. temp. Isink=2mA

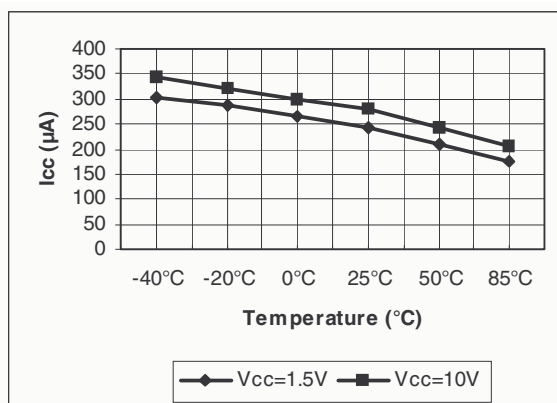

Figure 7. Vref vs. temp. Vcc=1.8V

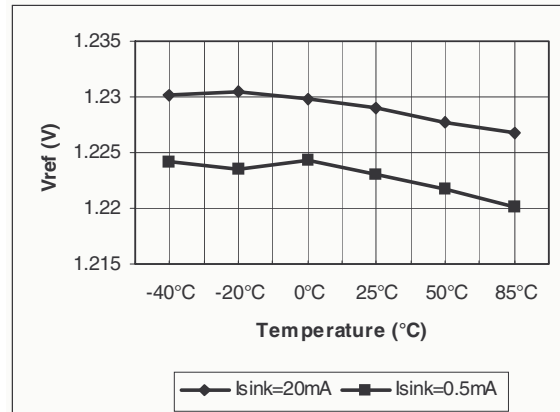

Figure 8. dV_{ref}/dI_{sink} vs. temp. $V_{cc}=1.8V$

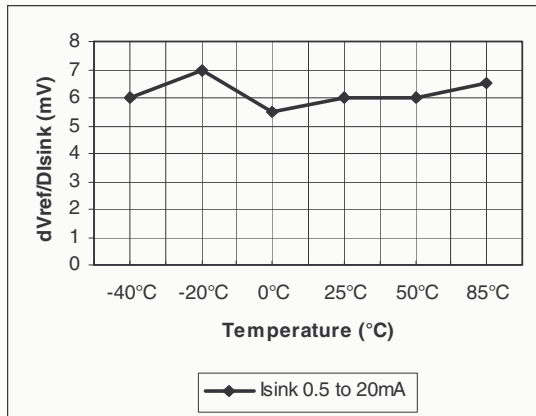

Figure 9. I_{ref} vs. temp. $V_{cc}=1.8V$

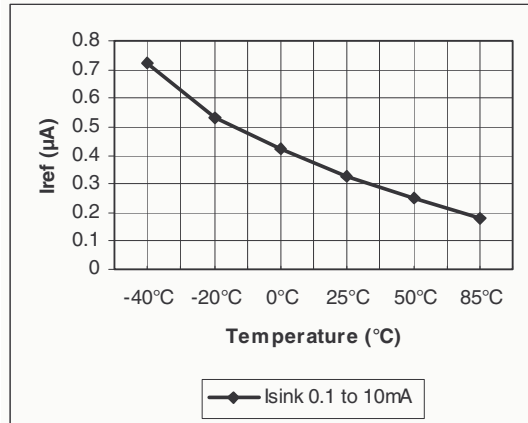
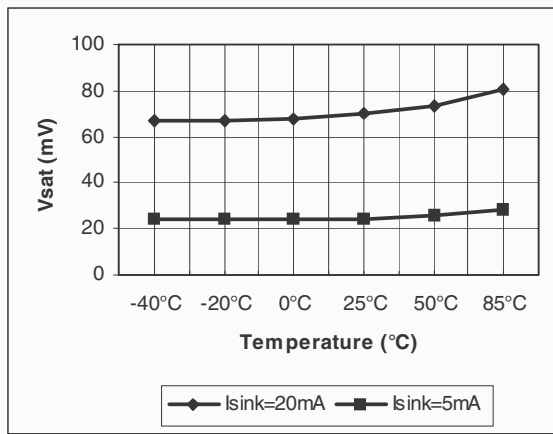

Figure 10. V_{sat} vs. temp. $V_{cc}=1.8V$



4 Package Mechanical Data

In order to meet environmental requirements, ST offers these devices in ECOPACK® packages. These packages have a Lead-free second level interconnect. The category of second level interconnect is marked on the package and on the inner box label, in compliance with JEDEC Standard JESD97. The maximum ratings related to soldering conditions are also marked on the inner box label. ECOPACK is an ST trademark. ECOPACK specifications are available at: www.st.com.

SOT23-5L Package

| SOT23-5L MECHANICAL DATA | | | | | | |
|--------------------------|------|------|------|-------|------|-------|
| DIM. | mm. | | | mils | | |
| | MIN. | TYP. | MAX. | MIN. | TYP. | MAX. |
| A | 0.90 | | 1.45 | 35.4 | | 57.1 |
| A1 | 0.00 | | 0.15 | 0.0 | | 5.9 |
| A2 | 0.90 | | 1.30 | 35.4 | | 51.2 |
| b | 0.35 | | 0.50 | 13.7 | | 19.7 |
| C | 0.09 | | 0.20 | 3.5 | | 7.8 |
| D | 2.80 | | 3.00 | 110.2 | | 118.1 |
| E | 2.60 | | 3.00 | 102.3 | | 118.1 |
| E1 | 1.50 | | 1.75 | 59.0 | | 68.8 |
| e | | 0.95 | | | 37.4 | |
| e1 | | 1.9 | | | 74.8 | |
| L | 0.35 | | 0.55 | 13.7 | | 21.6 |

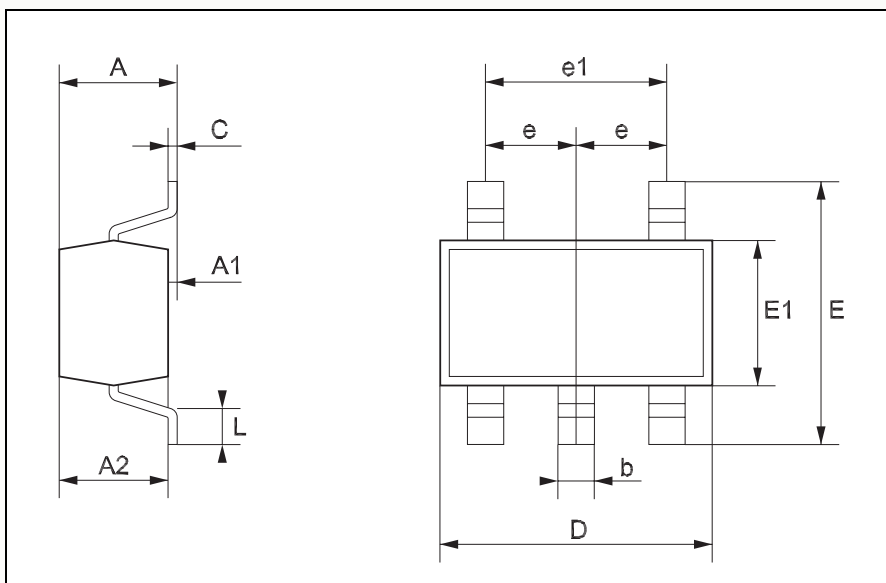

5 Revision History

| Date | Revision | Changes |
|------------|----------|---|
| March 2005 | 1 | First release corresponding to Preliminary Data version of datasheet. |
| Nov. 2005 | 2 | First release of fully mature product data sheet. |

Information furnished is believed to be accurate and reliable. However, STMicroelectronics assumes no responsibility for the consequences of use of such information nor for any infringement of patents or other rights of third parties which may result from its use. No license is granted by implication or otherwise under any patent or patent rights of STMicroelectronics. Specifications mentioned in this publication are subject to change without notice. This publication supersedes and replaces all information previously supplied. STMicroelectronics products are not authorized for use as critical components in life support devices or systems without express written approval of STMicroelectronics.

The ST logo is a registered trademark of STMicroelectronics.
All other names are the property of their respective owners

© 2005 STMicroelectronics - All rights reserved

STMicroelectronics group of companies

Australia - Belgium - Brazil - Canada - China - Czech Republic - Finland - France - Germany - Hong Kong - India - Israel - Italy - Japan - Malaysia - Malta - Morocco - Singapore - Spain - Sweden - Switzerland - United Kingdom - United States of America

www.st.com

Данный компонент на территории Российской Федерации

Вы можете приобрести в компании MosChip.

Для оперативного оформления запроса Вам необходимо перейти по данной ссылке:

<http://moschip.ru/get-element>

Вы можете разместить у нас заказ для любого Вашего проекта, будь то серийное производство или разработка единичного прибора.

В нашем ассортименте представлены ведущие мировые производители активных и пассивных электронных компонентов.

Нашей специализацией является поставка электронной компонентной базы двойного назначения, продукции таких производителей как XILINX, Intel (ex.ALTERA), Vicor, Microchip, Texas Instruments, Analog Devices, Mini-Circuits, Amphenol, Glenair.

Сотрудничество с глобальными дистрибьюторами электронных компонентов, предоставляет возможность заказывать и получать с международных складов практически любой перечень компонентов в оптимальные для Вас сроки.

На всех этапах разработки и производства наши партнеры могут получить квалифицированную поддержку опытных инженеров.

Система менеджмента качества компании отвечает требованиям в соответствии с ГОСТ Р ИСО 9001, ГОСТ РВ 0015-002 и ЭС РД 009

Офис по работе с юридическими лицами:

105318, г.Москва, ул.Щербаковская д.3, офис 1107, 1118, ДЦ «Щербаковский»

Телефон: +7 495 668-12-70 (многоканальный)

Факс: +7 495 668-12-70 (доб.304)

E-mail: info@moschip.ru

Skype отдела продаж:

moschip.ru

moschip.ru_4

moschip.ru_6

moschip.ru_9