

OptiMOS™3 Power-MOSFET
Features

- Fast switching MOSFET for SMPS
- Optimized technology for DC/DC converters
- Qualified according to JEDEC¹⁾ for target applications
- N-channel; Logic level
- Excellent gate charge x $R_{DS(on)}$ product (FOM)
- Very low on-resistance $R_{DS(on)}$
- Superior thermal resistance
- Avalanche rated
- Pb-free plating; RoHS compliant; Halogen Free
- Halogen-free according to IEC61249-2-21

Product Summary

| | | |
|------------------|-----|------------|
| V_{DS} | 30 | V |
| $R_{DS(on),max}$ | 5.8 | m Ω |
| I_D | 40 | A |

PG-TSDSON-8

| Type | Package | Marking |
|---------------|-------------|---------|
| BSZ058N03LS G | PG-TSDSON-8 | 058N03L |

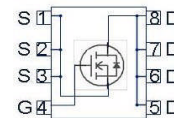
Maximum ratings, at $T_j=25\text{ }^\circ\text{C}$, unless otherwise specified

| Parameter | Symbol | Conditions | Value | Unit |
|---|---------------|--|----------|-------------------|
| Continuous drain current | I_D | $V_{GS}=10\text{ V}, T_C=25\text{ }^\circ\text{C}$ | 40 | A |
| | | $V_{GS}=10\text{ V}, T_C=100\text{ }^\circ\text{C}$ | 40 | |
| | | $V_{GS}=4.5\text{ V}, T_C=25\text{ }^\circ\text{C}$ | 40 | |
| | | $V_{GS}=4.5\text{ V}, T_C=100\text{ }^\circ\text{C}$ | 36 | |
| | | $V_{GS}=10\text{ V}, T_A=25\text{ }^\circ\text{C}, R_{thJA}=60\text{ K/W}^2)$ | 15 | |
| Pulsed drain current ³⁾ | $I_{D,pulse}$ | $T_C=25\text{ }^\circ\text{C}$ | 160 | |
| Avalanche current, single pulse ⁴⁾ | I_{AS} | $T_C=25\text{ }^\circ\text{C}$ | 20 | |
| Avalanche energy, single pulse | E_{AS} | $I_D=20\text{ A}, R_{GS}=25\text{ }\Omega$ | 55 | mJ |
| Reverse diode dv/dt | dv/dt | $I_D=40\text{ A}, V_{DS}=24\text{ V}, di/dt=200\text{ A}/\mu\text{s}, T_{j,max}=150\text{ }^\circ\text{C}$ | 6 | kV/ μs |
| Gate source voltage | V_{GS} | | ± 20 | V |

¹⁾ J-STD20 and JESD22

Maximum ratings, at $T_j=25\text{ °C}$, unless otherwise specified

| Parameter | Symbol | Conditions | Value | Unit |
|-------------------------------------|-----------------------|--|-------------|------|
| Power dissipation | P_{tot} | $T_C=25\text{ °C}$ | 45 | W |
| | | $T_A=25\text{ °C}$, $R_{\text{thJA}}=60\text{ K/W}^2)$ | 2.1 | |
| Operating and storage temperature | T_j, T_{stg} | | -55 ... 150 | °C |
| IEC climatic category; DIN IEC 68-1 | | | 55/150/56 | |

| Parameter | Symbol | Conditions | Values | | | Unit |
|-----------|--------|------------|--------|------|------|------|
| | | | min. | typ. | max. | |

Thermal characteristics

| | | | | | | |
|-------------------------------------|-------------------|--|---|---|-----|-----|
| Thermal resistance, junction - case | R_{thJC} | | - | - | 2.8 | K/W |
| Device on PCB | R_{thJA} | 6 cm ² cooling area ²⁾ | - | - | 60 | |

Electrical characteristics, at $T_j=25\text{ °C}$, unless otherwise specified

Static characteristics

| | | | | | | |
|----------------------------------|-----------------------------|---|-----|-----|-----|---------------|
| Drain-source breakdown voltage | $V_{(\text{BR})\text{DSS}}$ | $V_{\text{GS}}=0\text{ V}, I_{\text{D}}=1\text{ mA}$ | 30 | - | - | V |
| Gate threshold voltage | $V_{\text{GS(th)}}$ | $V_{\text{DS}}=V_{\text{GS}}, I_{\text{D}}=250\text{ }\mu\text{A}$ | 1 | - | 2.2 | |
| Zero gate voltage drain current | I_{DSS} | $V_{\text{DS}}=30\text{ V}, V_{\text{GS}}=0\text{ V}, T_j=25\text{ °C}$ | - | 0.1 | 1 | μA |
| | | $V_{\text{DS}}=30\text{ V}, V_{\text{GS}}=0\text{ V}, T_j=125\text{ °C}$ | - | 10 | 100 | |
| Gate-source leakage current | I_{GSS} | $V_{\text{GS}}=20\text{ V}, V_{\text{DS}}=0\text{ V}$ | - | 10 | 100 | nA |
| Drain-source on-state resistance | $R_{\text{DS(on)}}$ | $V_{\text{GS}}=4.5\text{ V}, I_{\text{D}}=20\text{ A}$ | - | 7.1 | 8.9 | m Ω |
| | | $V_{\text{GS}}=10\text{ V}, I_{\text{D}}=20\text{ A}$ | - | 4.8 | 5.8 | |
| Gate resistance | R_{G} | | 0.6 | 1.3 | 2.3 | Ω |
| Transconductance | g_{fs} | $ V_{\text{DS}} >2 I_{\text{D}} R_{\text{DS(on)max}}, I_{\text{D}}=30\text{ A}$ | 36 | 71 | - | S |

²⁾ Device on 40 mm x 40 mm x 1.5 mm epoxy PCB FR4 with 6 cm² (one layer, 70 μm thick) copper area for drain connection. PCB is vertical in still air.

³⁾ See figure 3 for more detailed information

| Parameter | Symbol | Conditions | Values | | | Unit |
|-----------|--------|------------|--------|------|------|------|
| | | | min. | typ. | max. | |

Dynamic characteristics

| | | | | | | |
|------------------------------|--------------|---|---|------|------|----|
| Input capacitance | C_{iss} | $V_{GS}=0\text{ V}, V_{DS}=15\text{ V},$ $f=1\text{ MHz}$ | - | 1800 | 2400 | pF |
| Output capacitance | C_{oss} | | - | 690 | 920 | |
| Reverse transfer capacitance | C_{rss} | | - | 36 | - | |
| Turn-on delay time | $t_{d(on)}$ | $V_{DD}=15\text{ V}, V_{GS}=10\text{ V},$ $I_D=30\text{ A}, R_G=1.6\ \Omega$ | - | 4.6 | - | ns |
| Rise time | t_r | | - | 3.6 | - | |
| Turn-off delay time | $t_{d(off)}$ | | - | 19 | - | |
| Fall time | t_f | | - | 3.2 | - | |

Gate Charge Characteristics⁵⁾

| | | | | | | |
|------------------------------|---------------|---|---|-----|-----|----|
| Gate to source charge | Q_{gs} | $V_{DD}=15\text{ V}, I_D=30\text{ A},$ $V_{GS}=0\text{ to }4.5\text{ V}$ | - | 5.5 | 7.4 | nC |
| Gate charge at threshold | $Q_{g(th)}$ | | - | 2.8 | 3.7 | |
| Gate to drain charge | Q_{gd} | | - | 2.5 | 4.2 | |
| Switching charge | Q_{sw} | | - | 5.3 | 7.9 | |
| Gate charge total | Q_g | | - | 11 | 14 | |
| Gate plateau voltage | $V_{plateau}$ | | - | 3.2 | - | |
| Gate charge total | Q_g | $V_{DD}=15\text{ V}, I_D=30\text{ A},$ $V_{GS}=0\text{ to }10\text{ V}$ | - | 22 | 30 | nC |
| Gate charge total, sync. FET | $Q_{g(sync)}$ | $V_{DS}=0.1\text{ V},$ $V_{GS}=0\text{ to }4.5\text{ V}$ | - | 9 | 13 | |
| Output charge | Q_{oss} | $V_{DD}=15\text{ V}, V_{GS}=0\text{ V}$ | - | 18 | 24 | |

Reverse Diode

| | | | | | | |
|----------------------------------|---------------|---|---|------|-----|----|
| Diode continuous forward current | I_S | $T_C=25\text{ }^\circ\text{C}$ | - | - | 40 | A |
| Diode pulse current | $I_{S,pulse}$ | | - | - | 160 | |
| Diode forward voltage | V_{SD} | $V_{GS}=0\text{ V}, I_F=20\text{ A},$ $T_j=25\text{ }^\circ\text{C}$ | - | 0.83 | 1.1 | V |
| Reverse recovery charge | Q_{rr} | $V_R=15\text{ V}, I_F=I_S,$ $di_F/dt=400\text{ A}/\mu\text{s}$ | - | - | 10 | nC |

⁴⁾ See figure 13 for more detailed information

⁵⁾ See figure 16 for gate charge parameter definition

1 Power dissipation

$P_{tot}=f(T_C)$

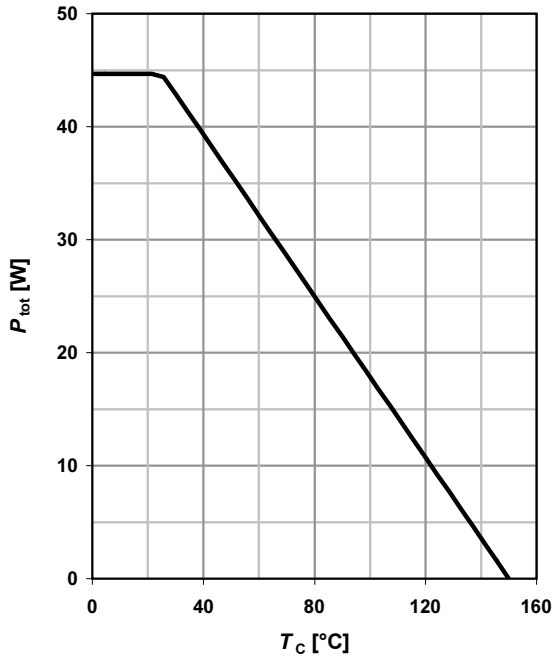

2 Drain current

$I_D=f(T_C); V_{GS} \geq 10 V$

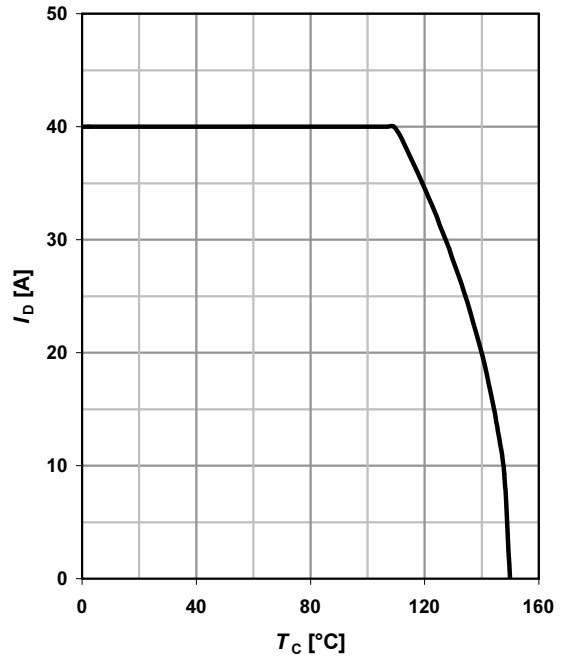

3 Safe operating area

$I_D=f(V_{DS}); T_C=25^\circ C; D=0$

parameter: t_p

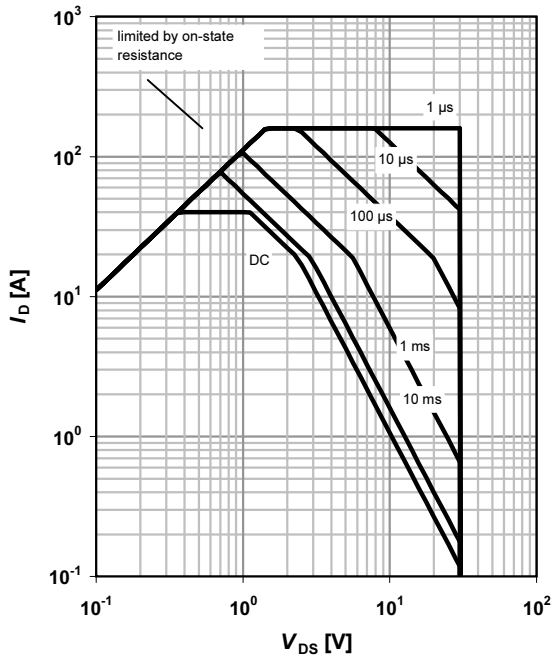

4 Max. transient thermal impedance

$Z_{thJC}=f(t_p)$

parameter: $D=t_p/T$

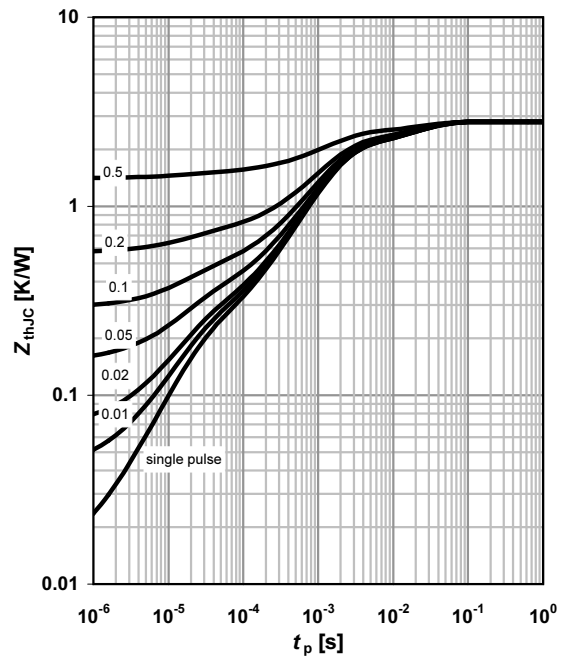

5 Typ. output characteristics

$I_D = f(V_{DS}); T_j = 25\text{ }^\circ\text{C}$

parameter: V_{GS}

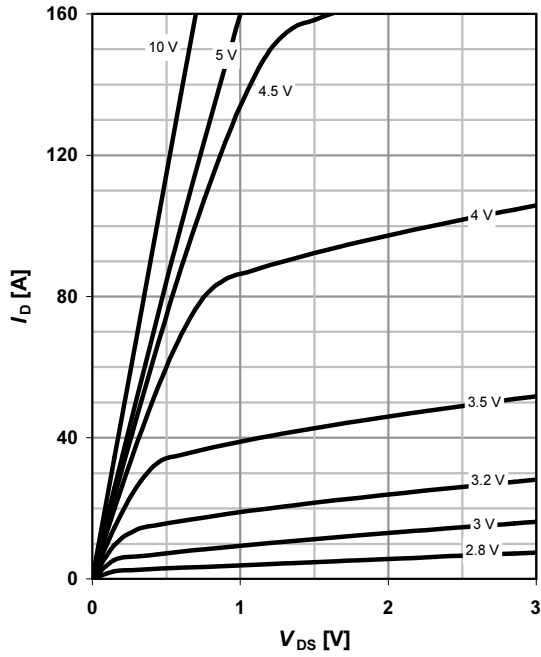

6 Typ. drain-source on resistance

$R_{DS(on)} = f(I_D); T_j = 25\text{ }^\circ\text{C}$

parameter: V_{GS}

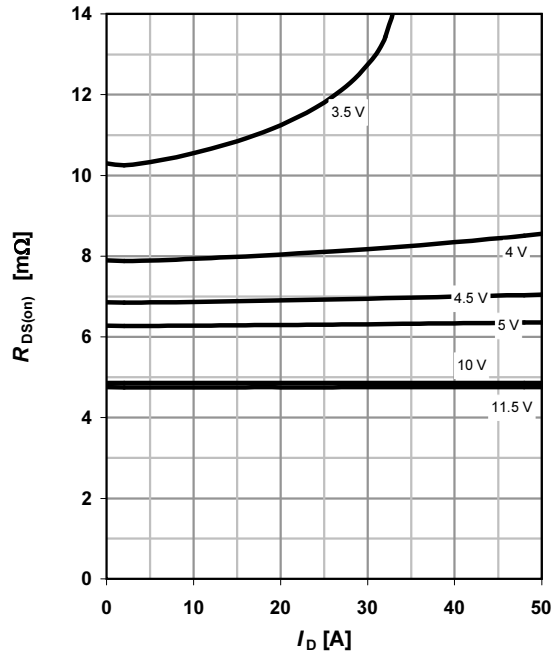

7 Typ. transfer characteristics

$I_D = f(V_{GS}); |V_{DS}| > 2|I_D|R_{DS(on)max}$

parameter: T_j

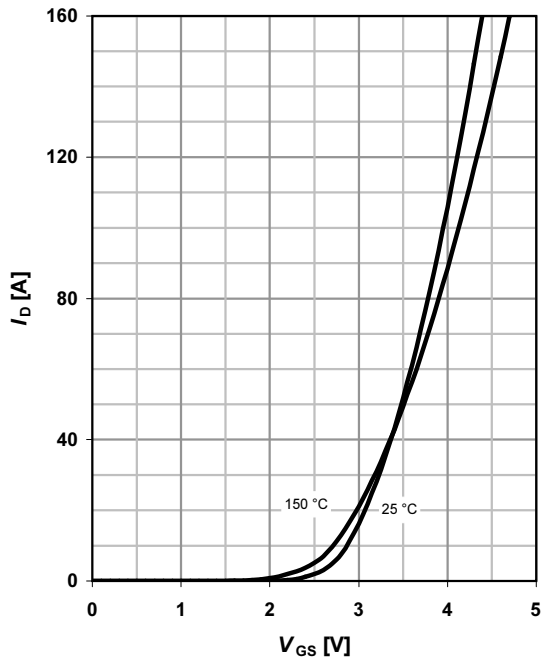

8 Typ. forward transconductance

$g_{fs} = f(I_D); T_j = 25\text{ }^\circ\text{C}$

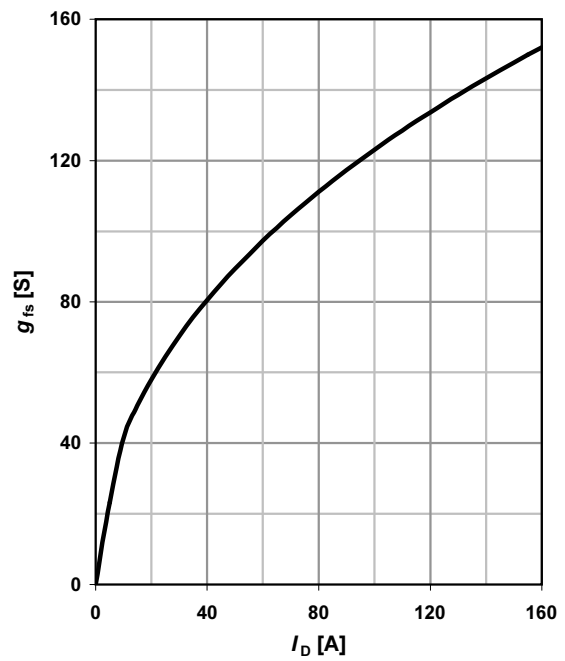

9 Drain-source on-state resistance

$R_{DS(on)} = f(T_j); I_D = 20 \text{ A}; V_{GS} = 10 \text{ V}$

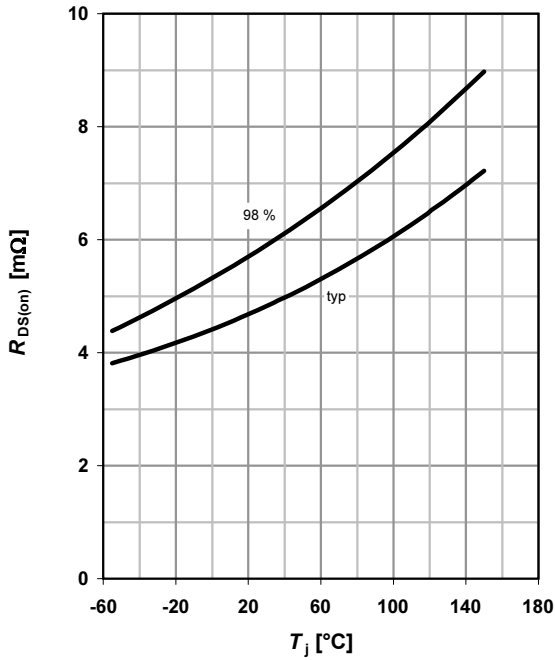

10 Typ. gate threshold voltage

$V_{GS(th)} = f(T_j); V_{GS} = V_{DS}; I_D = 250 \mu\text{A}$

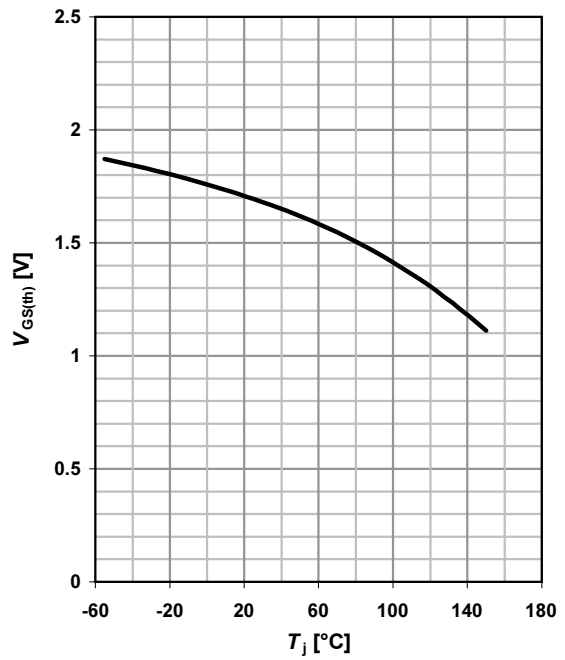

11 Typ. capacitances

$C = f(V_{DS}); V_{GS} = 0 \text{ V}; f = 1 \text{ MHz}$

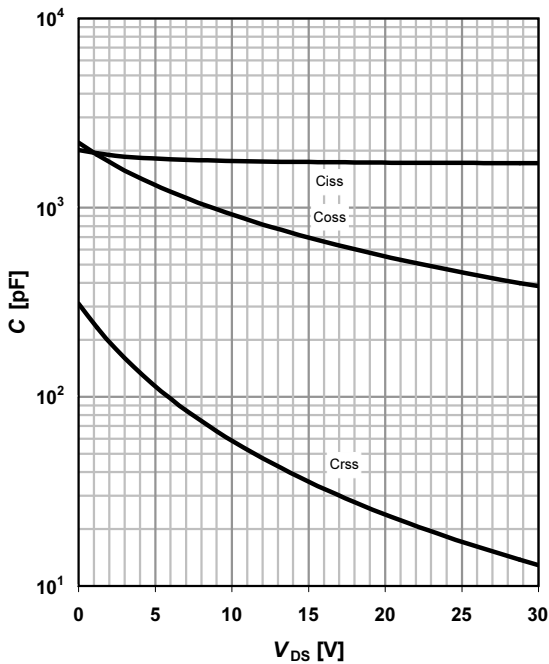

12 Forward characteristics of reverse diode

$I_F = f(V_{SD})$

parameter: T_j

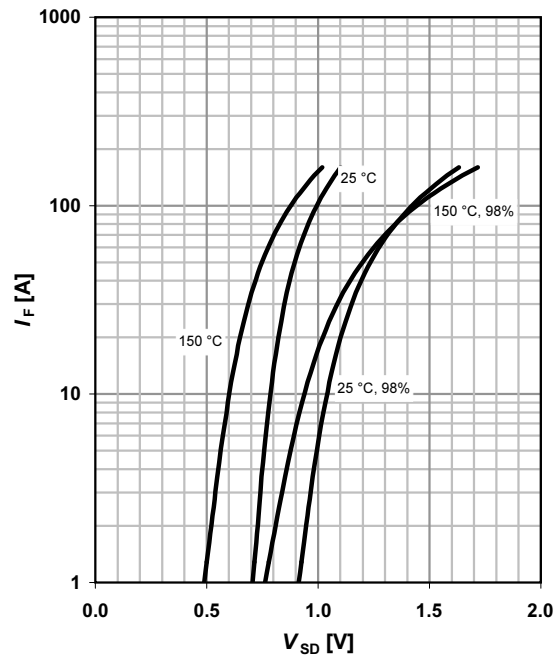

13 Avalanche characteristics

$I_{AS}=f(t_{AV}); R_{GS}=25 \Omega$

parameter: $T_{j(start)}$

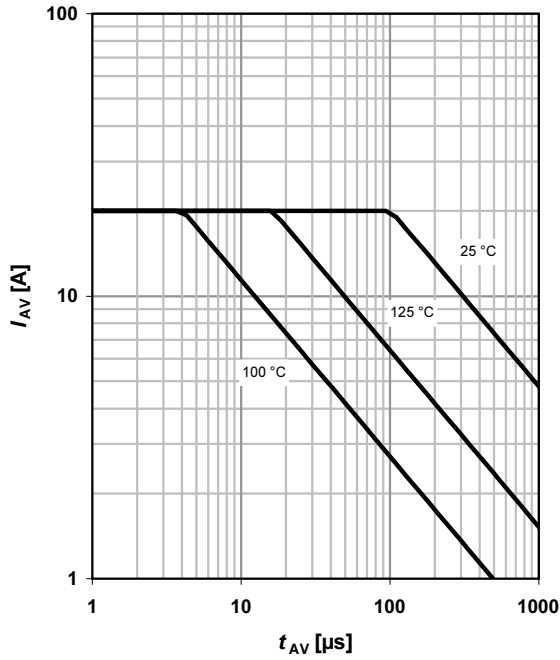

14 Typ. gate charge

$V_{GS}=f(Q_{gate}); I_D=30 \text{ A pulsed}$

parameter: V_{DD}

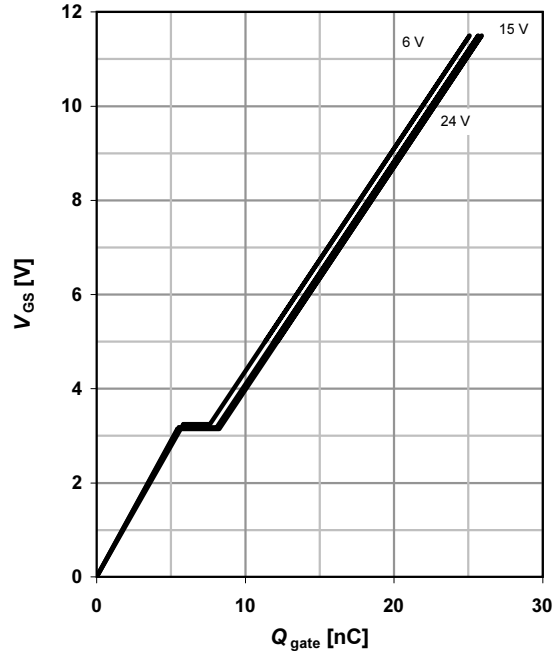

15 Drain-source breakdown voltage

$V_{BR(DSS)}=f(T_j); I_D=1 \text{ mA}$

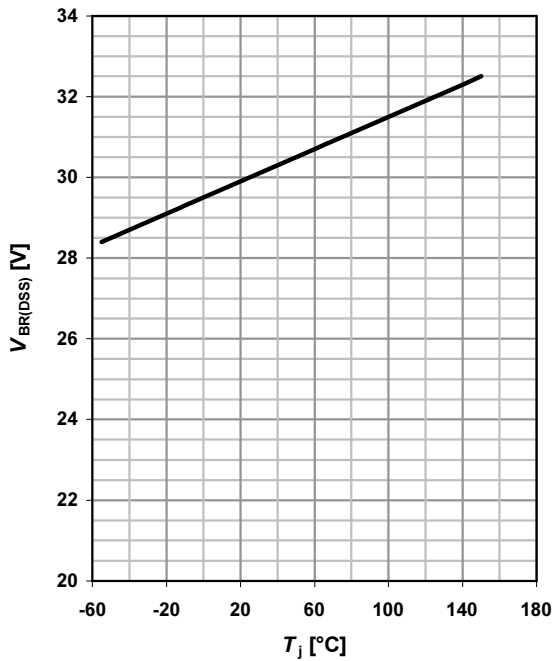

16 Gate charge waveforms



Package Outline

PG-TSDSON-8

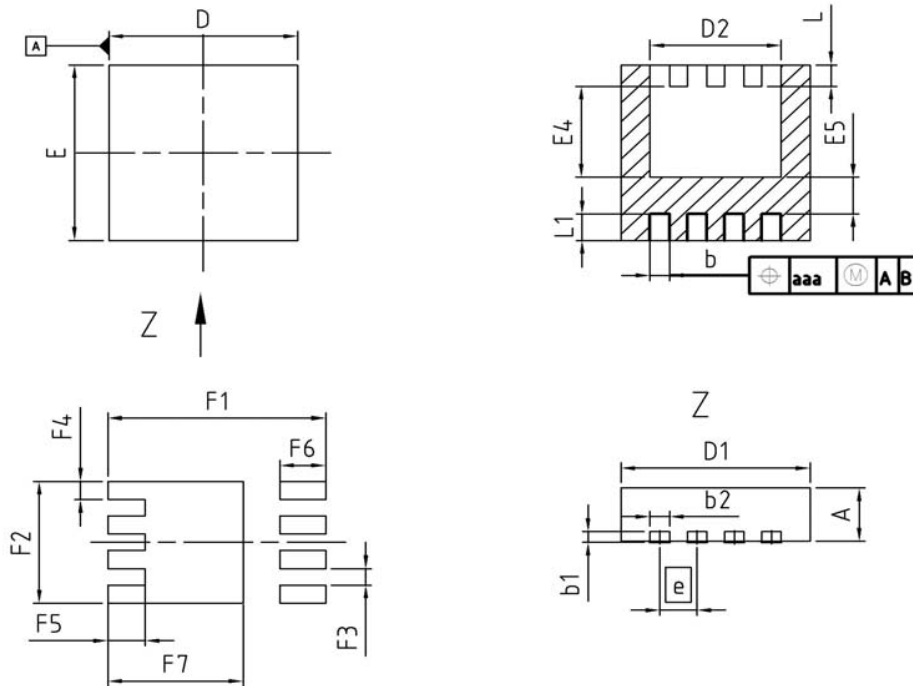

| DIM | MILLIMETERS | | INCHES | |
|------|-------------|------|--------|-------|
| | MIN | MAX | MIN | MAX |
| A | 0.90 | 1.10 | 0.035 | 0.043 |
| b | 0.24 | 0.44 | 0.009 | 0.017 |
| b1 | 0.10 | 0.30 | 0.004 | 0.012 |
| b2 | 0.20 | 0.44 | 0.008 | 0.017 |
| D=D1 | 3.20 | 3.40 | 0.126 | 0.134 |
| D2 | 2.15 | 2.45 | 0.085 | 0.096 |
| E | 3.20 | 3.40 | 0.126 | 0.134 |
| E4 | 1.60 | 1.81 | 0.063 | 0.071 |
| E5 | 0.59 | 0.86 | 0.023 | 0.034 |
| e | 0.65 | | 0.026 | |
| N | 8 | | 8 | |
| L | 0.30 | 0.56 | 0.012 | 0.022 |
| L1 | 0.33 | 0.60 | 0.013 | 0.024 |
| aaa | 0.25 | | 0.010 | |
| F1 | 3.80 | | 0.150 | |
| F2 | 2.29 | | 0.090 | |
| F3 | 0.31 | | 0.012 | |
| F4 | 0.34 | | 0.013 | |
| F5 | 0.65 | | 0.026 | |
| F6 | 0.80 | | 0.031 | |
| F7 | 2.36 | | 0.093 | |

DOCUMENT NO.
Z8B00131645

SCALE

EUROPEAN PROJECTION

ISSUE DATE
17-09-2008

REVISION
02

Published by
Infineon Technologies AG
81726 Munich, Germany
© 2009 Infineon Technologies AG
All Rights Reserved.

Legal Disclaimer

The information given in this document shall in no event be regarded as a guarantee of conditions or characteristics. With respect to any examples or hints given herein, any typical values stated herein and/or any information regarding the application of the device, Infineon Technologies hereby disclaims any and all warranties and liabilities of any kind, including without limitation, warranties of non-infringement of intellectual property rights of any third party.

Information

For further information on technology, delivery terms and conditions and prices, please contact the nearest Infineon Technologies Office (www.infineon.com).

Warnings

Due to technical requirements, components may contain dangerous substances. For information on the types in question, please contact the nearest Infineon Technologies Office. The Infineon Technologies component described in this Data Sheet may be used in life-support devices or systems and/or automotive, aviation and aerospace applications or systems only with the express written approval of Infineon Technologies, if a failure of such components can reasonably be expected to cause the failure of that life-support, automotive, aviation and aerospace device or system or to affect the safety or effectiveness of that device or system. Life support devices or systems are intended to be implanted in the human body or to support and/or maintain and sustain and/or protect human life. If they fail, it is reasonable to assume that the health of the user or other persons may be endangered.

Данный компонент на территории Российской Федерации

Вы можете приобрести в компании MosChip.

Для оперативного оформления запроса Вам необходимо перейти по данной ссылке:

<http://moschip.ru/get-element>

Вы можете разместить у нас заказ для любого Вашего проекта, будь то серийное производство или разработка единичного прибора.

В нашем ассортименте представлены ведущие мировые производители активных и пассивных электронных компонентов.

Нашей специализацией является поставка электронной компонентной базы двойного назначения, продукции таких производителей как XILINX, Intel (ex.ALTERA), Vicor, Microchip, Texas Instruments, Analog Devices, Mini-Circuits, Amphenol, Glenair.

Сотрудничество с глобальными дистрибьюторами электронных компонентов, предоставляет возможность заказывать и получать с международных складов практически любой перечень компонентов в оптимальные для Вас сроки.

На всех этапах разработки и производства наши партнеры могут получить квалифицированную поддержку опытных инженеров.

Система менеджмента качества компании отвечает требованиям в соответствии с ГОСТ Р ИСО 9001, ГОСТ РВ 0015-002 и ЭС РД 009

Офис по работе с юридическими лицами:

105318, г.Москва, ул.Щербаковская д.3, офис 1107, 1118, ДЦ «Щербаковский»

Телефон: +7 495 668-12-70 (многоканальный)

Факс: +7 495 668-12-70 (доб.304)

E-mail: info@moschip.ru

Skype отдела продаж:

moschip.ru

moschip.ru_4

moschip.ru_6

moschip.ru_9