

Part Number	Description
ZD20CF*	2A, 60 Vdc, short-circuit protected up to 33 Vdc, solid-state relay for through-hole mounting
SZD20CF*	2A, 60 Vdc, short-circuit protected up to 33 Vdc, solid-state relay for surface mount

*W for +25°C ambient; T for over-temperature screen

ELECTRICAL SPECIFICATIONS

(-55°C to +105°C ambient temperature unless otherwise specified)

INPUT (CONTROL) SPECIFICATIONS

	Min	Max	Units
Input Current	8	20	mA
Input Voltage @10mA	2	3	Vdc
Must Turn-On	8		mA
Must Turn-Off Current		100	µA
Must Turn-Off Voltage		0.8	Vdc
Reverse Polarity	-6		Vdc

OUTPUT (LOAD) SPECIFICATIONS

	Min	Max	Units
Load Voltage Range	0	60	Vdc
Output Current Rating (See Figure 5)		2.0	A
Leakage Current at Rated Voltage		10	µA
Transient Blocking Voltage @25°C		100	Vdc
Output Capacitance @25Vdc (25°C)		600	pF
Output Voltage Drop @2A		0.30	Vdc
On Resistance		0.15	Ohm
Turn-On Time		3.0	ms
Turn-Off Time		1.0	ms
Trip Overload	(See Figure 6)		A
Short Circuit Protection		33	Vdc
Operating Frequency		10	Hz

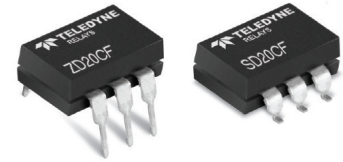

FEATURES/BENEFITS

- Short-circuit protected
- Overload protected
- 2 Amp load
- Low off-state leakage
- Optical isolation
- Compact 6-pin package

DESCRIPTION

ZD20CF Series Relays have optical isolation between relay input and output. Loads may be connected to either the positive or negative output terminals. ZD20CF Relays act as electronic circuit breakers that sense shorted loads or other overload events and then trip-off. Relay contacts open and no current flows through the relay and associated loads. These relays prevent overcurrent damage to the system. Cycling the relay on-off removes the tripped or latched-off condition and returns the relay to the normal operating state.

GENERAL SPECIFICATIONS

(+25°C ambient temperature unless otherwise specified)

ENVIRONMENTAL SPECIFICATIONS

	Min	Max	Units
Operating Temperature	-55	+105	°C
Storage Temperature	-55	+125	°C
Junction Temperature @2A		+125	°C
Thermal Resistance θ_{JA}		+120	°C/W
Dielectric Strength	1000		Vac
Insulation Resistance (@500 Vdc)	10 ⁹		Ohm
Input to Output Capacitance		5	pF
Shock	MIL-STD-202, method 213, cond. F, 1500g		
Vibration	MIL-STD-202, method 204, cond. F, 100g		
Resistance to Soldering Heat	MIL STD 202, method 210		
Solderability	MIL STD 202, method 208		
Thermal Shock	MIL STD 202, method 107		

MECHANICAL SPECIFICATIONS



Weight: 0.035 oz. (1g) maximum
Case: 6-pin dual in-line filled epoxy

TOLERANCES: .XX = ±0.10 (±.25), .XXX = ±0.005 (±.13)
DIMENSION STYLES: XXX = INCHES (XXX) = MILLIMETERS
CONTROLLING DIMENSIONS ARE IN INCHES. METRIC DIMENSIONS ARE SUPPLIED FOR REFERENCE PURPOSES ONLY.

PIN NO.	FUNCTION
1	+IN
2	-IN
3	-IN
4	-OUT
5	-OUT
6	+OUT



Figure 1

TYPICAL WIRING DIAGRAM



*Shorted internally
**Series resistor required to limit input current to 20mA maximum

Figure 2

CONTROL CURRENT VS. INPUT VOLTAGE



Figure 3

TYPICAL TURN-ON TIME VS. INPUT CURRENT



Figure 4

LOAD CURRENT VS. AMBIENT TEMPERATURE

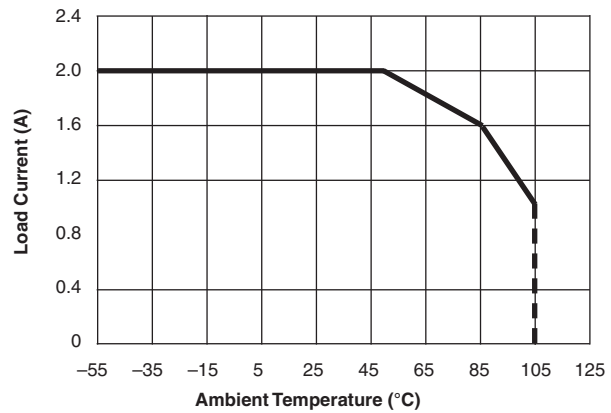

Figure 5

TYPICAL OVERLOAD CURRENT VS. TRIP TIME

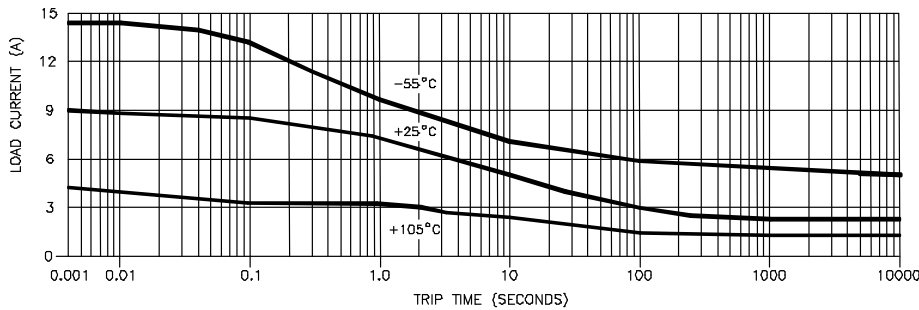

Figure 6

FUNCTIONAL BLOCK DIAGRAM

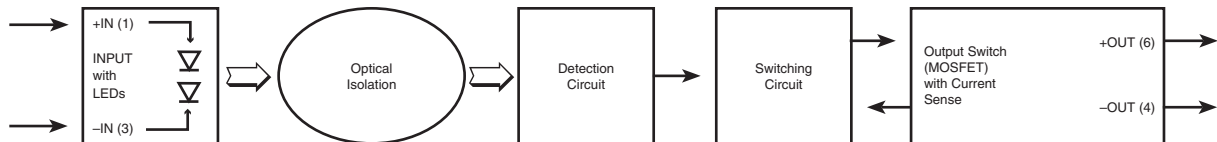

Figure 7

NOTES:

1. The ZD20CF relay's input current should be limited to between 8 and 20mA. An external resistor whose value = $(V_{IN} - 2.5 \text{ volts}) \div 0.012$ Amps is a good choice for limiting input current.
2. Relay input transitions should be less than 1.0 millisecond.
3. Loads may be attached to either the positive or negative output terminal.
4. Maximum load current ratings are with the relay in free air and soldered to a printed circuit board.
5. Timing is measured from the input current transition to the 10% or 90% points on the output voltage transition.
6. Overload conditions (including shorted loads) are specified for load supply voltages to 33 Vdc maximum.
7. For through-hole-PCB-solder-attaching ZD20CF series relays, the wave-solder or solder pot operations are limited to +260°C maximum for 10 seconds, maximum.
8. For surface-mount-solder-attaching SZD20CF series relays, in IR heating or convection heating systems, the component temperature is limited to +235°C maximum for 10 seconds maximum.

Данный компонент на территории Российской Федерации

Вы можете приобрести в компании MosChip.

Для оперативного оформления запроса Вам необходимо перейти по данной ссылке:

<http://moschip.ru/get-element>

Вы можете разместить у нас заказ для любого Вашего проекта, будь то серийное производство или разработка единичного прибора.

В нашем ассортименте представлены ведущие мировые производители активных и пассивных электронных компонентов.

Нашей специализацией является поставка электронной компонентной базы двойного назначения, продукции таких производителей как XILINX, Intel (ex.ALTERA), Vicor, Microchip, Texas Instruments, Analog Devices, Mini-Circuits, Amphenol, Glenair.

Сотрудничество с глобальными дистрибьюторами электронных компонентов, предоставляет возможность заказывать и получать с международных складов практически любой перечень компонентов в оптимальные для Вас сроки.

На всех этапах разработки и производства наши партнеры могут получить квалифицированную поддержку опытных инженеров.

Система менеджмента качества компании отвечает требованиям в соответствии с ГОСТ Р ИСО 9001, ГОСТ РВ 0015-002 и ЭС РД 009

Офис по работе с юридическими лицами:

105318, г.Москва, ул.Щербаковская д.3, офис 1107, 1118, ДЦ «Щербаковский»

Телефон: +7 495 668-12-70 (многоканальный)

Факс: +7 495 668-12-70 (доб.304)

E-mail: info@moschip.ru

Skype отдела продаж:

moschip.ru

moschip.ru_4

moschip.ru_6

moschip.ru_9