

**SxX8xSx Series**



**Main Features**

Symbol	Value	Unit
$I_{T(RMS)}$	0.8	A
$V_{DRM} / V_{RRM}$	400 to 800	V
$I_{GT}$	5 to 200	$\mu$ A

**Applications**

The SxX8xSx EV series is specifically designed for GFCI (Ground Fault Circuit Interrupter) and gas ignition applications.

**Description**

New device series offers high static dv/dt and lower turn off ( $t_q$ ) sensitive SCR with its small die planar construction design. It is specifically designed for GFCI (Ground Fault Circuit Interrupter) and Gas Ignition applications. All SCRs junctions are glass-passivated to ensure long term reliability and parametric stability.

**Features**

- RoHS compliant and Halogen-Free
- Thru-hole and surface mount packages
- Surge current capability > 10Amps
- Blocking voltage ( $V_{DRM} / V_{RRM}$ ) capability - up to 800V
- High dv/dt noise immunity
- Improved turn-off time ( $t_q$ ) < 25  $\mu$ sec
- Sensitive gate for direct microprocessor interface

**Schematic Symbol**



**Absolute Maximum Ratings**

Symbol	Parameter	Value	Unit
$I_{T(RMS)}$	RMS on-state current (full sine wave)	TO-92 $T_c = 55^\circ\text{C}$	0.8 A
		SOT-89 $T_c = 60^\circ\text{C}$	0.8 A
		SOT-223 $T_L = 60^\circ\text{C}$	0.8 A
$I_{T(AV)}$	Average on-state current	TO-92 $T_c = 55^\circ\text{C}$	0.51 A
		SOT-89 $T_c = 60^\circ\text{C}$	0.51 A
		SOT-223 $T_L = 60^\circ\text{C}$	0.51 A
$I_{TSM}$	Non repetitive surge peak on-state current (Single cycle, $T_j$ initial = $25^\circ\text{C}$ )	TO-92 $F = 50\text{Hz}$	8 A
		SOT-89 $F = 60\text{Hz}$ SOT-223	10 A
$I^2t$	$I^2t$ Value for fusing	$t_p = 10\text{ ms}$ $F = 50\text{ Hz}$	0.32 $\text{A}^2\text{s}$
		$t_p = 8.3\text{ ms}$ $F = 60\text{ Hz}$	0.41 $\text{A}^2\text{s}$
di/dt	Critical rate of rise of on-state current $I_G = 10\text{mA}$	TO-92 $T_j = 125^\circ\text{C}$ SOT-89 SOT-223	50 $\text{A}/\mu\text{s}$
$I_{GM}$	Peak Gate Current	$t_p = 10\ \mu\text{s}$ $T_j = 125^\circ\text{C}$	1.0 A
$P_{G(AV)}$	Average gate power dissipation	$T_j = 125^\circ\text{C}$	0.1 W
$T_{stg}$	Storage junction temperature range	—	-40 to 150 $^\circ\text{C}$
$T_j$	Operating junction temperature range	—	-40 to 125 $^\circ\text{C}$

**Electrical Characteristics (T<sub>J</sub> = 25°C, unless otherwise specified)**

Symbol	Description	Test Conditions	Limit	Value			Unit
				SxX8yS1	SxX8yS2	SxX8yS	
I <sub>GT</sub>	DC Gate Trigger Current	V <sub>D</sub> = 6V R <sub>L</sub> = 100 Ω	MIN.	0.5	1	15	μA
			MAX.	5	50	200	μA
V <sub>GT</sub>	DC Gate Trigger Voltage	V <sub>D</sub> = 6V R <sub>L</sub> = 100 Ω	MAX.	0.8			V
V <sub>GRM</sub>	Peak Reverse Gate Voltage	I <sub>RG</sub> = 10μA	MIN.	5			V
I <sub>H</sub>	Holding Current	R <sub>GK</sub> = 1 kΩ Initial Current = 20mA	MAX.	5			mA
(dv/dt) <sub>s</sub>	Critical Rate-of-Rise of Off-State Voltage	T <sub>J</sub> = 125°C V <sub>D</sub> = V <sub>DRM</sub> / V <sub>RRM</sub> Exp. Waveform R <sub>GK</sub> = 1 kΩ	MIN.	75			V/μs
V <sub>GD</sub>	Gate Non-Trigger Voltage	V <sub>D</sub> = V <sub>DRM</sub> R <sub>GK</sub> = 1 kΩ T <sub>J</sub> = 25°C	MIN.	0.2			V
t <sub>q</sub>	Turn-Off Time	T <sub>J</sub> = 25°C @ 600 V R <sub>GK</sub> = 1 kΩ	MAX.	30	25	25	μs
t <sub>gt</sub>	Turn-On Time	I <sub>G</sub> = 10mA PW = 15μsec I <sub>T</sub> = 1.6A(pk)	TYP.	2.0	2.0	2.0	μs

Note: x = voltage, y = package

**Static Characteristics (T<sub>J</sub> = 25°C, unless otherwise specified)**

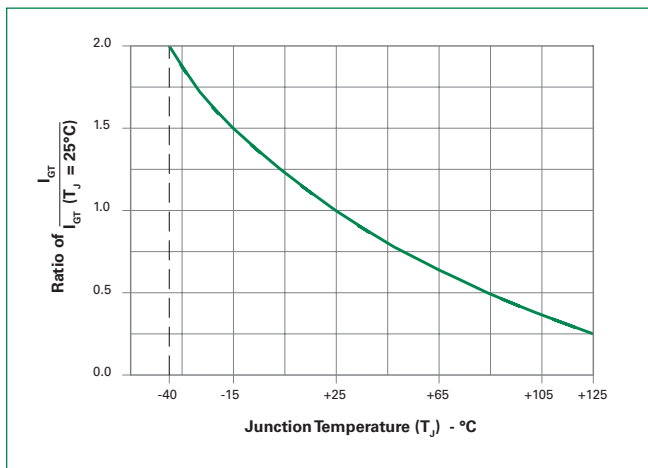
Symbol	Description	Test Conditions	Limit	Value	Unit
V <sub>TM</sub>	Peak On-State Voltage	I <sub>TM</sub> = 1.6A (pk)	MAX.	1.70	V
I <sub>DRM</sub>	Off-State Current, Peak Repetitive	T <sub>J</sub> = 25°C @ V <sub>D</sub> = V <sub>DRM</sub> R <sub>GK</sub> = 1 kΩ	MAX.	3	μA
		T <sub>J</sub> = 125°C @ V <sub>D</sub> = V <sub>DRM</sub> R <sub>GK</sub> = 1 kΩ	MAX.	500	μA

**Thermal Resistances**

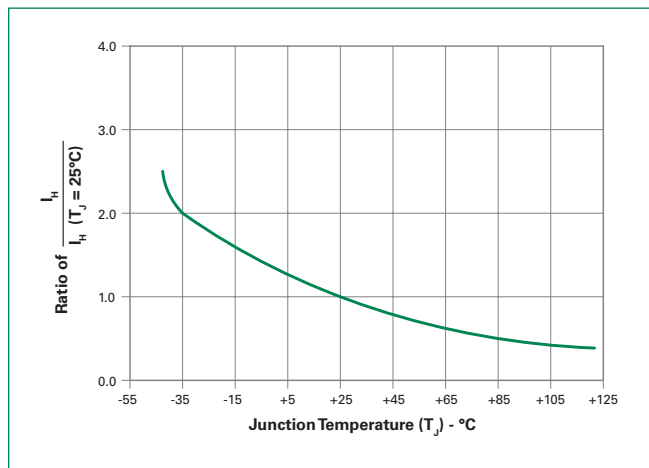
Symbol	Description	Test Conditions	Value	Unit	
R <sub>th(j-c)</sub>	Junction to case (AC)	I <sub>T</sub> = 0.8A <sub>(RMS)</sub> <sup>1</sup>	TO-92	75	°C/W
			SOT-223	30	°C/W
			SOT-89	50	°C/W
R <sub>th(j-a)</sub>	Junction to ambient	I <sub>T</sub> = 0.8A <sub>(RMS)</sub> <sup>1</sup>	TO-92	150	°C/W
			SOT-223	60	°C/W
			SOT-89	90	°C/W

<sup>1</sup> 60Hz AC resistive load condition, 100% conduction.

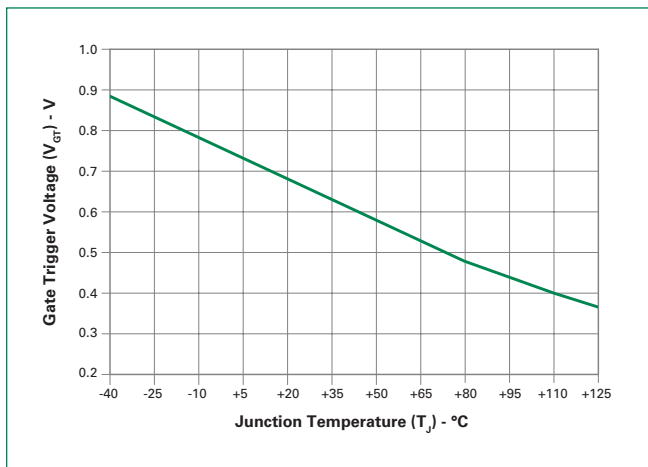
**Figure 1: Normalized DC Gate Trigger Current For All Quadrants vs. Junction Temperature**



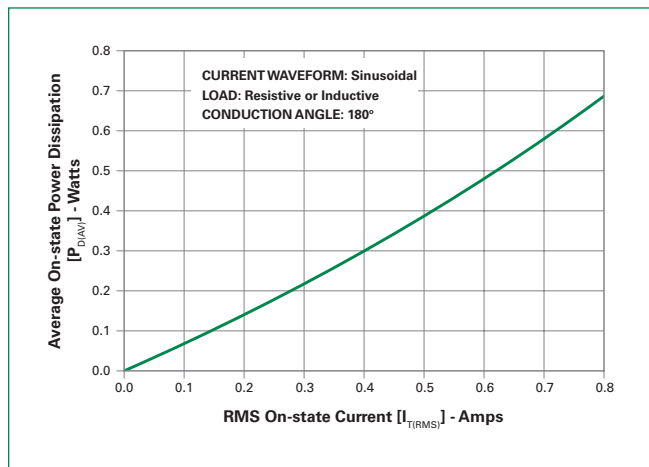
**Figure 2: Normalized DC Holding Current vs. Junction Temperature**



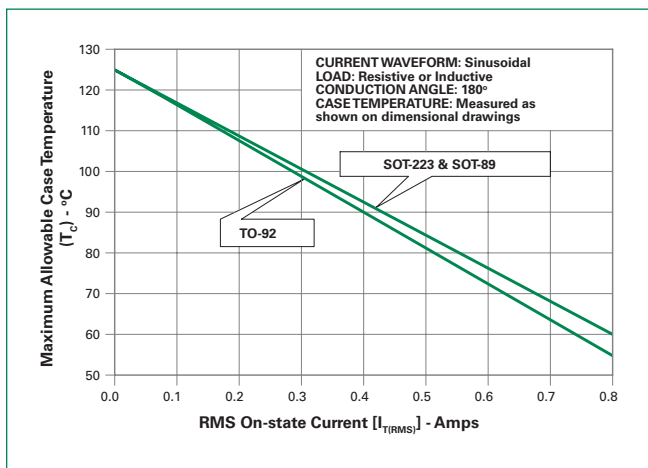
**Figure 3: Normalized DC Gate Trigger Voltage vs. Junction Temperature**



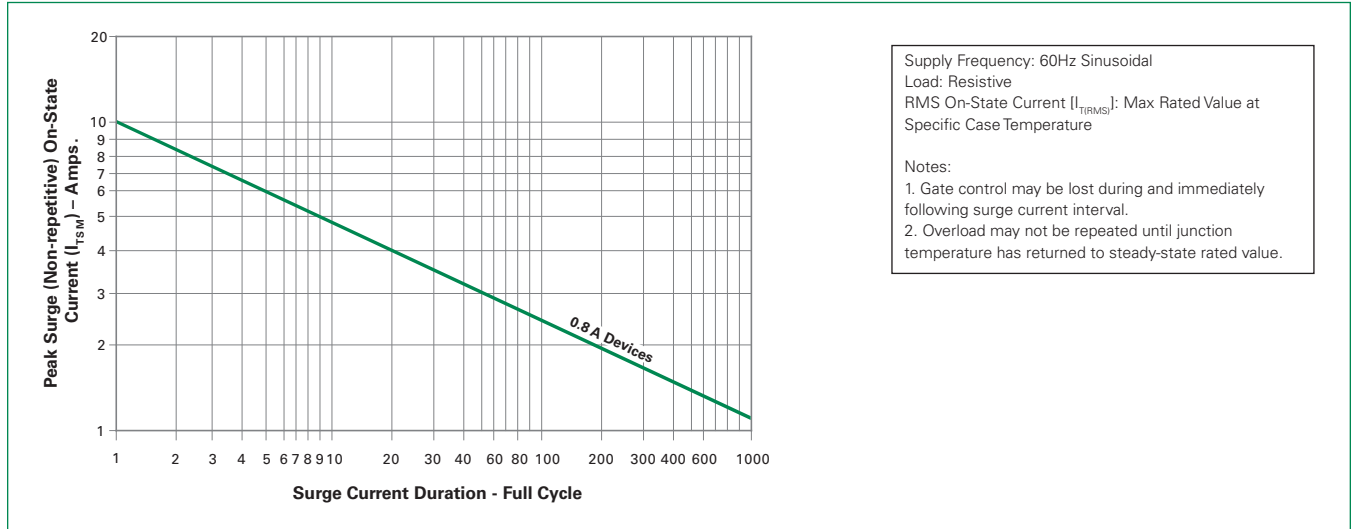
**Figure 4: Power Dissipation (Typical) vs. RMS On-State Current**



**Figure 5: Maximum Allowable Case Temperature vs. On-State Current**

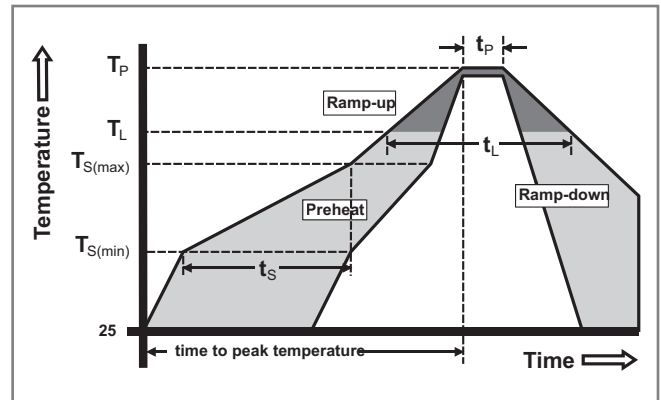


**Figure 6: Surge Peak On-State Current vs. Number of Cycles**



**Soldering Parameters**

Reflow Condition		Pb – Free assembly
Pre Heat	- Temperature Min ( $T_{s(min)}$ )	150°C
	- Temperature Max ( $T_{s(max)}$ )	200°C
	- Time (min to max) ( $t_s$ )	60 – 180 secs
Average ramp up rate (Liquidus Temp) ( $T_L$ ) to peak		5°C/second max
$T_{s(max)}$ to $T_L$ - Ramp-up Rate		5°C/second max
Reflow	- Temperature ( $T_L$ ) (Liquidus)	217°C
	- Time (min to max) ( $t_s$ )	60 – 150 seconds
Peak Temperature ( $T_p$ )		260 <sup>+0/-5</sup> °C
Time within 5°C of actual peak Temperature ( $t_p$ )		20 – 40 seconds
Ramp-down Rate		5°C/second max
Time 25°C to peak Temperature ( $T_p$ )		8 minutes Max.
Do not exceed		280°C



**Physical Specifications**

<b>Terminal Finish</b>	100% Matte Tin-plated.
<b>Body Material</b>	UL recognized epoxy meeting flammability classification 94V-0.
<b>Lead Material</b>	Copper Alloy

**Design Considerations**

Careful selection of the correct device for the application's operating parameters and environment will go a long way toward extending the operating life of the Thyristor. Good design practice should limit the maximum continuous current through the main terminals to 75% of the device rating. Other ways to ensure long life for a power discrete semiconductor are proper heat sinking and selection of voltage ratings for worst case conditions. Overheating, overvoltage (including dv/dt), and surge currents are the main killers of semiconductors. Correct mounting, soldering, and forming of the leads also help protect against component damage.

**Reliability/Environmental Tests**

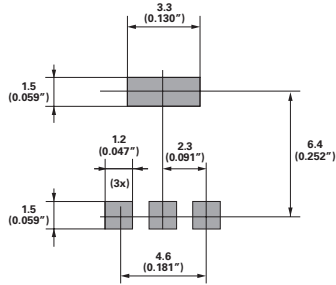
Test	Specifications and Conditions
<b>AC Blocking</b>	MIL-STD-750, M-1040, Cond A Applied Peak AC voltage @ 110°C for 1008 hours
<b>Temperature Cycling</b>	MIL-STD-750, M-1051, 100 cycles; -40°C to +150°C; 15-min dwell-time
<b>Temperature/Humidity</b>	EIA / JEDEC, JESD22-A101 1008 hours; 320V - DC: 85°C; 85% rel humidity
<b>High Temp Storage</b>	MIL-STD-750, M-1031, 1008 hours; 150°C
<b>Low-Temp Storage</b>	1008 hours; -40°C
<b>Thermal Shock</b>	MIL-STD-750, M-1056 10 cycles; 0°C to 100°C; 5-min dwell-time at each temperature; 10 sec (max) transfer time between temperature
<b>Autoclave</b>	EIA / JEDEC, JESD22-A102 168 hours (121°C at 2 ATMs) and 100% R/H
<b>Resistance to Solder Heat</b>	MIL-STD-750 Method 2031
<b>Solderability</b>	ANSI/J-STD-002, category 3, Test A
<b>Lead Bend</b>	MIL-STD-750, M-2036 Cond E

**Dimensions – TO-92**



Dimension	Inches		Millimeters	
	Min	Max	Min	Max
A	0.175	0.205	4.450	5.200
B	0.170	0.210	4.320	5.330
C	0.500		12.70	
D	0.135		3.430	
E	0.125	0.165	3.180	4.190
F	0.080	0.105	2.040	2.660
G	0.016	0.021	0.407	0.533
H	0.045	0.055	1.150	1.390
I	0.095	0.105	2.420	2.660
J	0.015	0.020	0.380	0.500

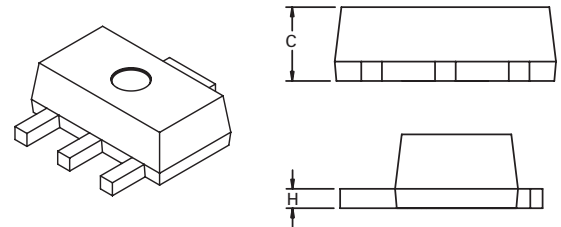
**Dimensions – SOT-223**



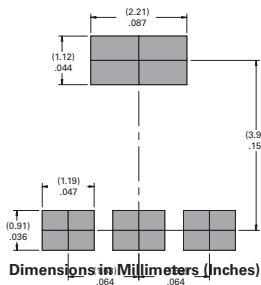
Dimensions in Millimeters (Inches)

Dimensions	Inches			Millimeters		
	Min	Typ	Max	Min	Typ	Max
A	0.248	0.256	0.264	6.30	6.50	6.70
B	0.130	0.138	0.146	3.30	3.50	3.70
C	—	—	0.071	—	—	1.80
D	0.001	—	0.004	0.02	—	0.10
E	0.114	0.118	0.124	2.90	3.00	3.15
F	0.024	0.027	0.034	0.60	0.70	0.85
G	—	0.090	—	—	2.30	—
H	—	0.181	—	—	4.60	—
I	0.264	0.276	0.287	6.70	7.00	7.30
J	0.009	0.010	0.014	0.24	0.26	0.35
K	10° MAX					

**Dimensions – SOT-89**



**Pad Layout for SOT-89**



Dimensions in Millimeters (Inches)

Dimension	Inches			Millimeters		
	Min	Typ	Max	Min	Typ	Max
A	0.173	—	0.181	4.40	—	4.60
B	0.090	—	0.102	2.29	—	2.60
C	0.055	—	0.063	1.40	—	1.60
D	0.155	—	0.167	3.94	—	4.25
E	0.035	—	0.047	0.89	—	1.20
F	0.056	—	0.062	1.42	—	1.57
G	0.115	—	0.121	2.92	—	3.07
H	0.014	—	0.017	0.35	—	0.44
I	0.014	—	0.019	0.36	—	0.48
J	0.064	—	0.072	1.62	—	1.83

**Product Selector**

Part Number	Voltage			Gate Sensitivity	Package
	400V	600V	800V		
S4X8ES	X	—	—	200 $\mu$ A	TO-92
S6X8ES	—	X	—	200 $\mu$ A	TO-92
S8X8ES	—	—	X	200 $\mu$ A	TO-92
S4X8TS	X	—	—	200 $\mu$ A	SOT-223
S6X8TS	—	X	—	200 $\mu$ A	SOT-223
S8X8TS	—	—	X	200 $\mu$ A	SOT-223
S4X8BS	X	—	—	200 $\mu$ A	SOT-89
S6X8BS	—	X	—	200 $\mu$ A	SOT-89
S4X8ES1	X	—	—	5 $\mu$ A	TO-92
S6X8ES1	—	X	—	5 $\mu$ A	TO-92
S8X8ES1	—	—	X	5 $\mu$ A	TO-92
S4X8TS1	X	—	—	5 $\mu$ A	SOT-223
S6X8TS1	—	X	—	5 $\mu$ A	SOT-223
S8X8TS1	—	—	X	5 $\mu$ A	SOT-223
S4X8ES2	X	—	—	50 $\mu$ A	TO-92
S6X8ES2	—	X	—	50 $\mu$ A	TO-92
S8X8ES2	—	—	X	50 $\mu$ A	TO-92
S4X8TS2	X	—	—	50 $\mu$ A	SOT-223
S6X8TS2	—	X	—	50 $\mu$ A	SOT-223
S8X8TS2	—	—	X	50 $\mu$ A	SOT-223

**Packing Options**

Part Number	Marking	Weight	Packing Mode	Base Quantity
SxX8ESy	SxX8ESy	0.170g	Bulk	2500
SxX8ESyAP	SxX8ESy	0.170g	Ammo Pack	2000
SxX8ESyRP	SxX8ESy	0.170g	Tape & Reel	2000
SxX8TSyRP	SxX8TSy	0.120g	Tape & Reel	1000
SxX8BSRP	xX8	0.053g	Tape & Reel	1000
SxX8BSRP1	xX8	0.053g	Tape & Reel	1000

Note: x = voltage, y = gate sensitivity

**TO-92 (3-lead) Reel Pack (RP) Radial Leaded Specifications**

Meets all EIA-468-C Standards



**TO-92 (3-lead) Ammo Pack (AP) Radial Leaded Specifications**

Meets all EIA-468-C Standards

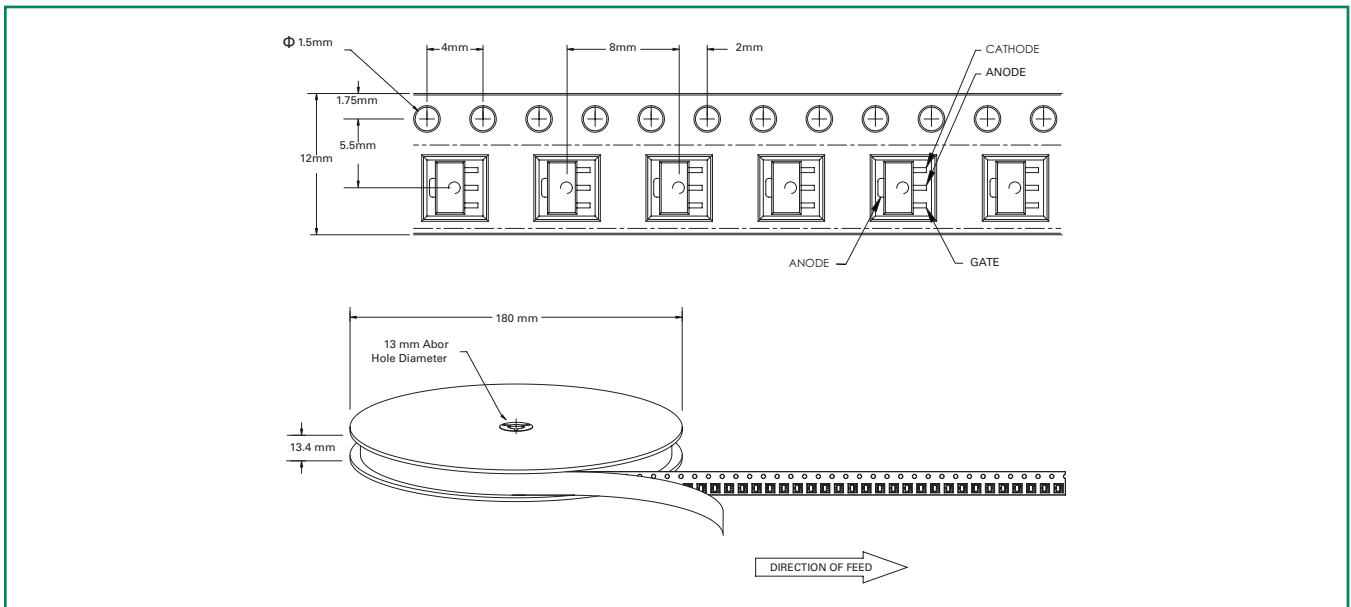




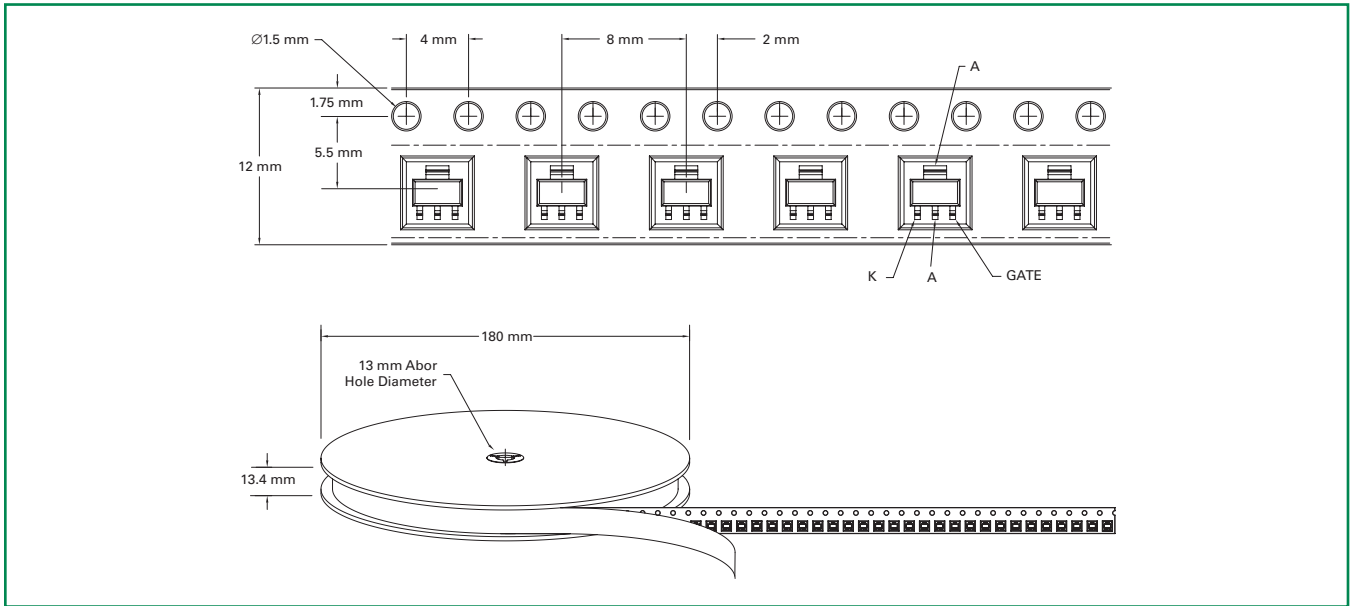
**SOT-89 Reel Pack (RP) Specifications**



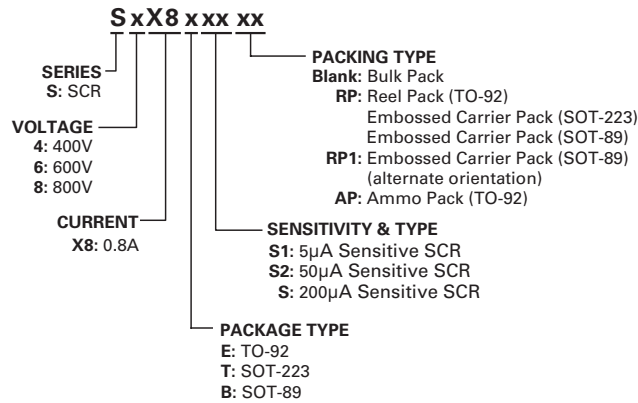
**SOT-89 Reel Pack (RP1) Specifications**



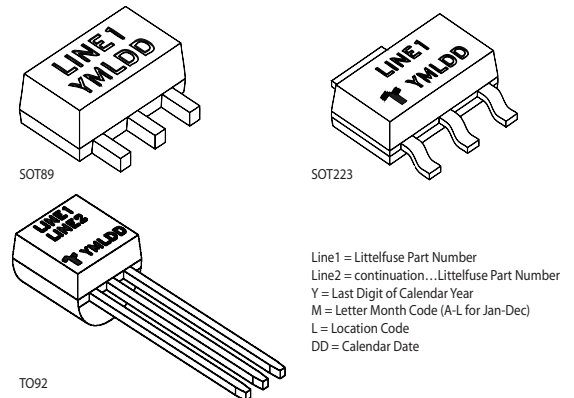
**SOT-223 Reel Pack (RP) Specifications**



**Part Numbering System**



**Part Marking System**



## Данный компонент на территории Российской Федерации

### Вы можете приобрести в компании MosChip.

Для оперативного оформления запроса Вам необходимо перейти по данной ссылке:

<http://moschip.ru/get-element>

Вы можете разместить у нас заказ для любого Вашего проекта, будь то серийное производство или разработка единичного прибора.

В нашем ассортименте представлены ведущие мировые производители активных и пассивных электронных компонентов.

Нашей специализацией является поставка электронной компонентной базы двойного назначения, продукции таких производителей как XILINX, Intel (ex.ALTERA), Vicor, Microchip, Texas Instruments, Analog Devices, Mini-Circuits, Amphenol, Glenair.

Сотрудничество с глобальными дистрибьюторами электронных компонентов, предоставляет возможность заказывать и получать с международных складов практически любой перечень компонентов в оптимальные для Вас сроки.

На всех этапах разработки и производства наши партнеры могут получить квалифицированную поддержку опытных инженеров.

Система менеджмента качества компании отвечает требованиям в соответствии с ГОСТ Р ИСО 9001, ГОСТ РВ 0015-002 и ЭС РД 009

### Офис по работе с юридическими лицами:

105318, г.Москва, ул.Щербаковская д.3, офис 1107, 1118, ДЦ «Щербаковский»

Телефон: +7 495 668-12-70 (многоканальный)

Факс: +7 495 668-12-70 (доб.304)

E-mail: [info@moschip.ru](mailto:info@moschip.ru)

Skype отдела продаж:

moschip.ru

moschip.ru\_4

moschip.ru\_6

moschip.ru\_9