

Encoder 20mm Size Metal Shaft Magnetic Type

EM20B Series



Highly reliable non-contact structure applicable to 31-point LED level indicator mounting.

- Detector
- Push
- Slide
- Rotary
- Encoders

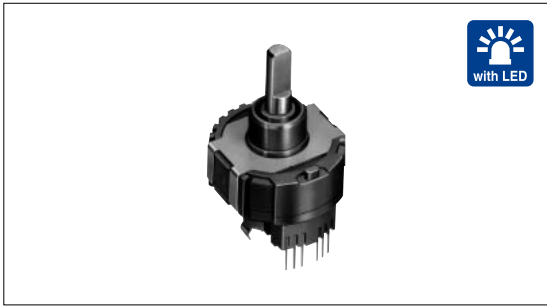

Typical Specifications

Items	Specifications
Rating	5V ± 5% DC
Operating life	500,000rotations

- Power
- Dual-in-line Package Type
- TACT Switch™

Product Line

Actuator length (mm)	Torque (mN·m)		Number of detent	Number of pulse	Operating direction	Push switch (N)	Display function	Response time	Minimum order unit (pcs.)	Product No.	Drawing No.
	Rotational torque	Detent torque									
15.5	7 max.	—	Without	40	Vertical	Without	Without	1.3 μ sec. (TYP)	480	EM20B4000000	1
										EM20B4010000	
16	—	8 ± 5	40			With (Switch operating force 6 ± 3)				EM20B4014000	2
10						With (Color : orange)				EM20B4014A01	3

- Incremental Type
- Absolute Type

Notes

- This product uses a Hall IC. Be aware of ESD damages.
- Custom design for shaft configuration and mount height are available upon request.

Dimensions

Unit:mm

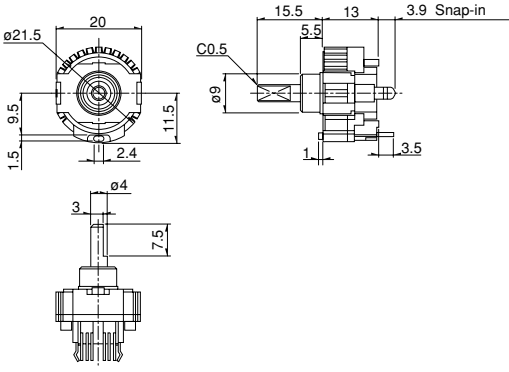
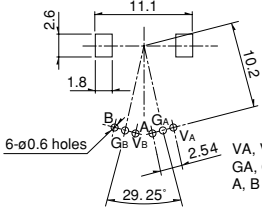
No.	Style	PC board mounting hole dimensions (Viewed from mounting side)
1	without switch type  	 6-φ0.6 holes VA, VB ... Power supply GA, GB ... Ground A, B Out put

Dimensions

Unit:mm

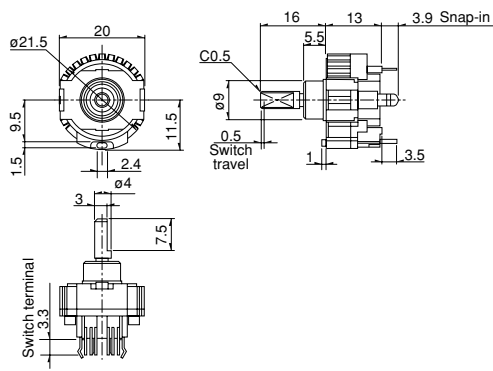
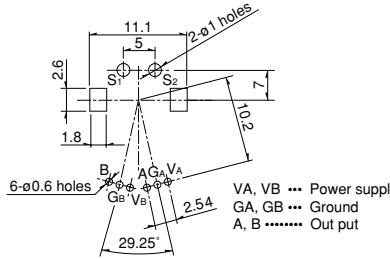
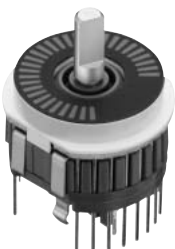
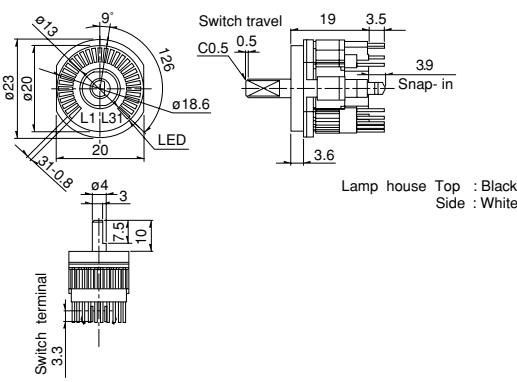
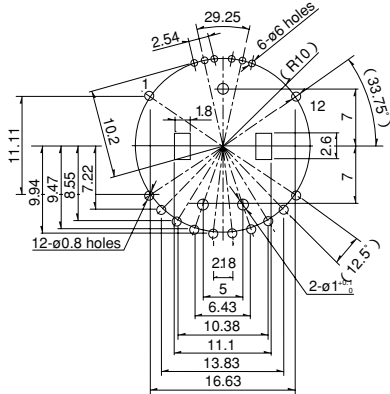
No.	Style	PC board mounting hole dimensions (Viewed from mounting side)
2	<p>With push-on switch (travel 0.5mm)</p>  	 <p>VA, VB ... Power supply GA, GB ... Ground A, B Out put</p>
3	<p>With LED With push-on switch (travel 0.5mm)</p>   <p>Lamp house Top : Black Side : White</p>	

Detector

Push

Slide

Rotary

Encoders

Power

Dual-in-line
 Package Type

TACT Switch™

Custom-
 Products



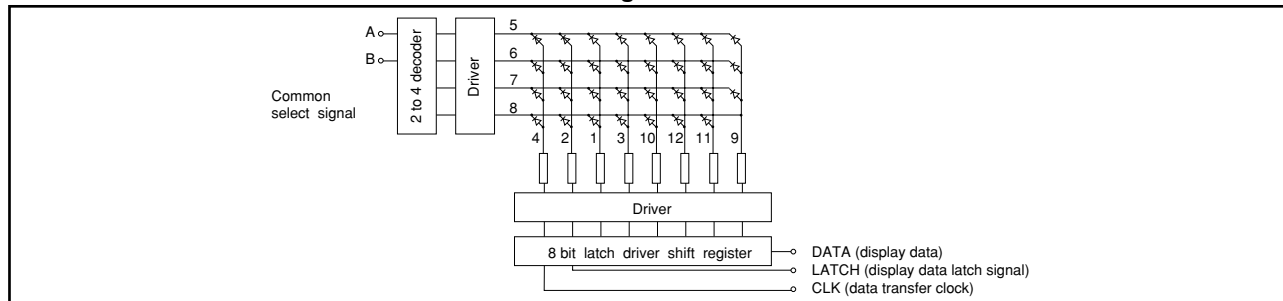

Incremental
 Type

Absolute
 Type

LED Unit Recommended Drive Circuit Block Diagram



List of Varieties

Type	Hollow shaft		Magnetic				
	5mm size	10mm size	11mm size	20mm size			
Series	EC05E	EC10E	EM11B	EM20B			
Detector							
Push							
Slide	Incremental						
Rotary Encoders Power Dual-in-line Package Type TACT Switch™ Custom-Products	Outline specifications	Hollow shaft		Single-shaft			
		Shaft types		Vertical			
		Operating direction		Horizontal			
		Number of pulse/ Number of detent		12/12	12/24	16/16	40/40
		Push switch (Travel mm)		Without		With(0.5)	Without/With(0.5)
		Optional functions				Display function	
Dimensions (mm)	W	5.7	9.8	10.8	20		
	D	2.7	12.6	11	22.25		
	H	6.5	4.4	7.5	13		
Soldering	Manual soldering	350 max. 3s max.					
	Dip soldering	—	260 ± 5 , 3 ± 1s	260 max. 3s max.			
	Reflow soldering	Please see P.189					
Operating temperature range	- 30 to + 85			-10 to + 70			
Maximum operating current(resistive load)	0.55mA	1mA	V _{HI} : + 4.0V min. V _{LO} : 0.5V max. (Isink=5mA)				
Incremental Type Absolute Type	Electrical performance	Output signal		Output of A and B signals, proportionate to phase difference			
		Output type		A,B(Square wave)			
		Instulation resistance		Incremental			
		Voltage proof		50M min. 50V DC	100M min. 100V DC	100M min. 250V DC	
Mechanical performance	Rotational torque		7mN·m max.				
	Detent torque		1.6 ± 1.3mN·m	5 ± 3mN·m	10 ± 5mN·m		
	Push-pull strength		100N				
Environmental performance	Cold		- 40 ± 3 for 240h	- 40 ± 3 for 96h	- 30 ± 3 for 240h		
	Dry heat		85 ± 3 for 240h	85 ± 3 for 96h	80 ± 3 for 240h		
	Damp heat		40 ± 2 , 90 to 95%RH for 240h	40 ± 2 , 90 to 95%RH for 96h	40 ± 2 , 90 to 95%RH for 240h		
Page	195	198	199	200			

Push-on Switch Specifications

Items	EM11B	EM20B
Contact arrangement	Single pole and single throw(Push-on)	
Travel(mm)	0.5 ^{+ 0.3} _{- 0.2}	0.5 ^{+ 0.4} _{- 0.3}
Operating force (N)	5.5 ± 3	6 ± 3
Rating	5mA 5V DC (50mA 12V DC)	
Contact resistance	500m max for initial period;5 max after operating life	100m max for initial period;200m max after operating life
Operating life	1,000,000times min.	
		25,000times min.

Encoders Attached Parts	209
Encoders Cautions	210, 211

Note

※ The operating temperature range for automotive applications can be raised upon request. Please contact us for requirements of this kind.

Данный компонент на территории Российской Федерации

Вы можете приобрести в компании MosChip.

Для оперативного оформления запроса Вам необходимо перейти по данной ссылке:

<http://moschip.ru/get-element>

Вы можете разместить у нас заказ для любого Вашего проекта, будь то серийное производство или разработка единичного прибора.

В нашем ассортименте представлены ведущие мировые производители активных и пассивных электронных компонентов.

Нашей специализацией является поставка электронной компонентной базы двойного назначения, продукции таких производителей как XILINX, Intel (ex.ALTERA), Vicor, Microchip, Texas Instruments, Analog Devices, Mini-Circuits, Amphenol, Glenair.

Сотрудничество с глобальными дистрибьюторами электронных компонентов, предоставляет возможность заказывать и получать с международных складов практически любой перечень компонентов в оптимальные для Вас сроки.

На всех этапах разработки и производства наши партнеры могут получить квалифицированную поддержку опытных инженеров.

Система менеджмента качества компании отвечает требованиям в соответствии с ГОСТ Р ИСО 9001, ГОСТ РВ 0015-002 и ЭС РД 009

Офис по работе с юридическими лицами:

105318, г.Москва, ул.Щербаковская д.3, офис 1107, 1118, ДЦ «Щербаковский»

Телефон: +7 495 668-12-70 (многоканальный)

Факс: +7 495 668-12-70 (доб.304)

E-mail: info@moschip.ru

Skype отдела продаж:

moschip.ru

moschip.ru_4

moschip.ru_6

moschip.ru_9