

**HLMP-1301, HLMP-1401, HLMP-1503,  
HLMP-K401, HLMP-K600**  
T-1 (3 mm) Diffused LED Lamps



**Data Sheet**



**Description**

This family of T-1 lamps is widely used in general-purpose indicator applications. Diffusants, tints, and optical design are balanced to yield superior light output and wide viewing angles. Several intensity choices are available in each color for increased design flexibility.

**Features**

- High intensity
- Choice of 4 bright colors:
  - High Efficiency Red
  - Orange
  - Yellow
  - High Performance Green
- Popular T-1 diameter package
- Selected minimum intensities
- Wide viewing angle
- General purpose leads
- Reliable and rugged
- Available on tape and reel

**Package Dimensions**

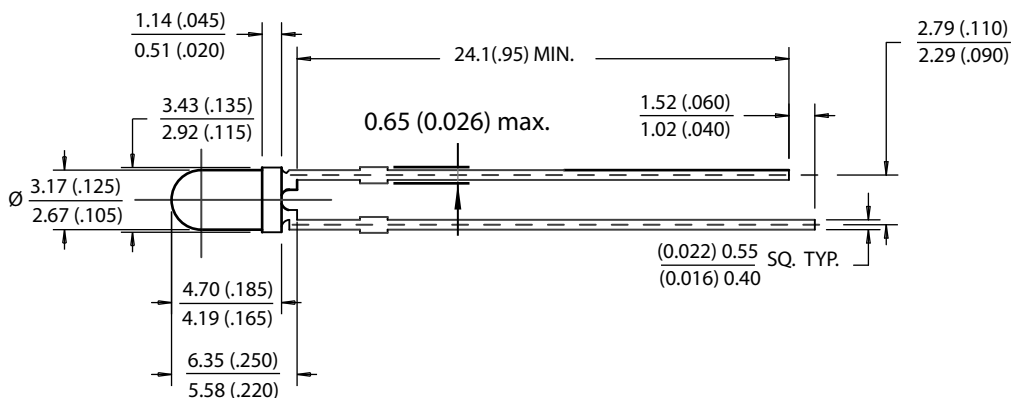

**Notes:**

1. All dimensions are in mm (inches).
2. An epoxy meniscus may extend about 1 mm (0.040") down the leads.
3. For PCB hole recommendations, see the Precautions section.

## Selection Guide

Material	Color	Part Number	Luminous Intensity I <sub>v</sub> (mcd) at 10 mA	
			Min.	Max.
GaAsP on GaP	Red	HLMP-1301	3.4	–
		HLMP-1301-E00xx	3.4	–
		HLMP-1301-FG0xx	5.4	17.2
		HLMP-1301-G00xx	8.6	–
		HLMP-1301-GH0xx	8.6	27.6
	Yellow	HLMP-1401	2.2	–
		HLMP-1401-D00xx	3.6	–
		HLMP-1401-E00xx	5.7	–
		HLMP-1401-EF0xx	5.7	18.4
		HLMP-1401-EFBxx	5.7	18.4
	Orange	HLMP-K401	2.1	–
		HLMP-K401-E00xx	3.4	–
		HLMP-K401-EF0xx	3.4	10.8
		HLMP-K401-FGDxx	5.4	17.2
GaP	Green	HLMP-1503	1.0	–
		HLMP-1503-C00xx	2.6	–
		HLMP-1503-D00xx	4.2	–
		HLMP-1503-DE0xx	4.2	13.4
		HLMP-1503-DEDxx	4.2	13.4
	Emerald Green <sup>[1]</sup>	HLMP-K600	1.0	–

Note:

1. Please refer to Application Note 1061 for information comparing standard green and emerald green light output degradation...

## Part Numbering System

HLMP - X X XX - X X X XX

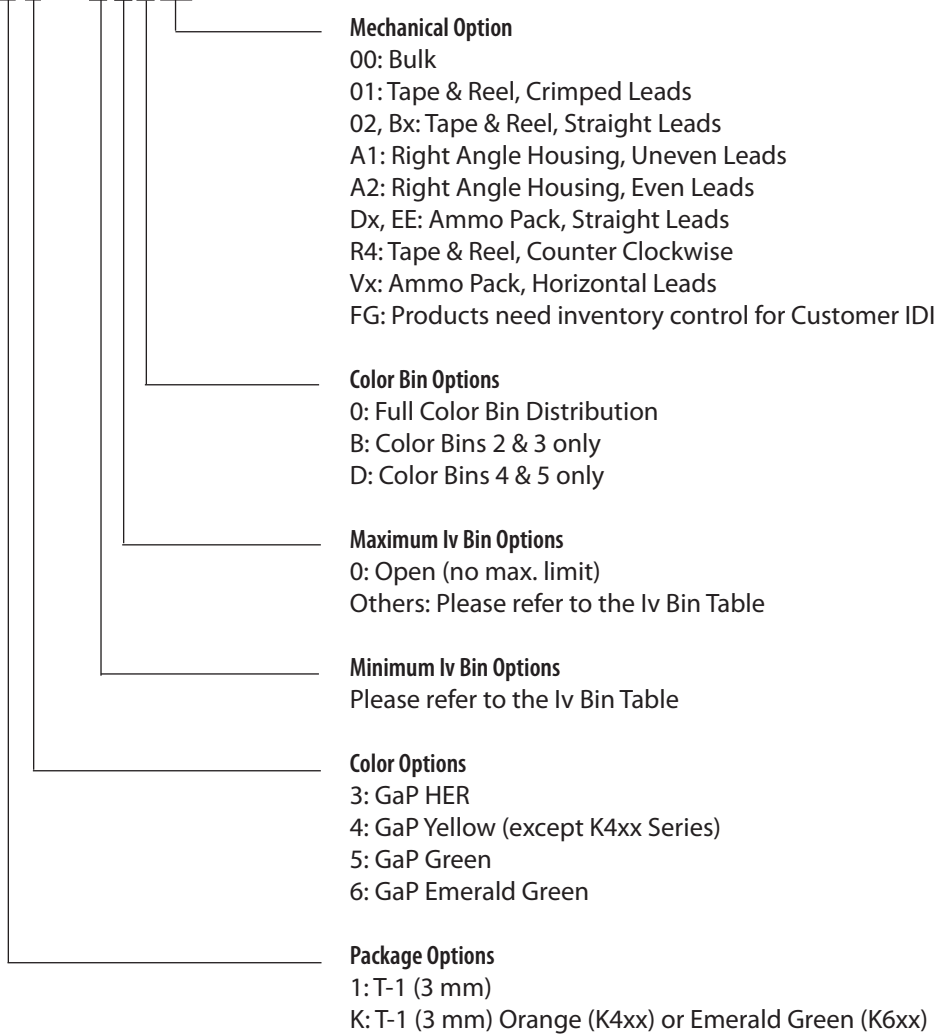

## Absolute Maximum Ratings at $T_A = 25\text{ }^\circ\text{C}$

Parameter	HER/Orange	Yellow	Green	Units
Peak Forward Current	90	60	90	mA
Average Forward Current <sup>[1]</sup>	25	20	25	mA
DC Current <sup>[2]</sup>	30	20	30	A R
Reverse Voltage (IR = 100 $\mu\text{A}$ )	5	5	5	V
Transient Forward Current <sup>[4]</sup> (10 $\mu\text{sec}$ Pulse)	500	500	500	mA
LED Junction Temperature	110	110	110	$^\circ\text{C}$
Operating Temperature Range	-40 to +100	-40 to +100	-20 to +100	$^\circ\text{C}$
Storage Temperature Range	-40 to +100	-40 to +100	-40 to +100	$^\circ\text{C}$

### Notes:

1. See Figure 5 (HER/Orange), 10 (Yellow), or 15 (Green/Emerald Green) to establish pulsed operating conditions.
2. For Red, Orange, and Green series derate linearly from  $50\text{ }^\circ\text{C}$  at  $0.5\text{ mA}/^\circ\text{C}$ . For Yellow series derate linearly from  $50\text{ }^\circ\text{C}$  at  $0.2\text{ mA}/^\circ\text{C}$ .
3. For Red, Orange, and Green series derate power linearly from  $25\text{ }^\circ\text{C}$  at  $1.8\text{ mW}/^\circ\text{C}$ . For Yellow series derate power linearly from  $50\text{ }^\circ\text{C}$  at  $1.6\text{ mW}/^\circ\text{C}$ .
4. The transient peak current is the maximum non-recurring peak current that can be applied to the device without damaging the LED die and wirebond. It is not recommended that the device be operated at peak currents beyond the peak forward current listed in the Absolute Maximum Ratings.

## Electrical Characteristics at $T_A = 25\text{ }^\circ\text{C}$

Symbol	Description	Device HLMP-	Min.	Typ.	Max.	Units	Test Conditions
$2\theta^{1/2}$	Included Angle Between Half Luminous Intensity Points	All		60		Deg.	$I_F = 10\text{ mA}$ See Note 1
$\lambda_{PEAK}$	Peak Wavelength	High Efficiency Red		635		nm	Measurement at Peak
		Orange		600			
		Yellow		583			
		Green		565			
		Emerald Green		558			
$\lambda_d$	Dominant Wavelength	High Efficiency Red		626		nm	See Note 2
		Orange		602			
		Yellow		585			
		Green		569			
		Emerald Green		560			
$\Delta\lambda^{1/2}$	Spectral Line Halfwidth	High Efficiency Red		40		nm	
		Yellow		36			
		Green		28			
		Emerald Green		24			
$\tau_s$	Speed of Response	High Efficiency Red		90		ns	
		Orange		280			
		Yellow		90			
		Green		500			
		Emerald Green		3100			
C	Capacitance	High Efficiency Red		11		pF	$V_F = 0;$ $f = 1\text{ MHz}$
		Orange		4			
		Yellow		15			
		Green		18			
		Emerald Green		35			
$R\theta_{J-PIN}$	Thermal Resistance	All		290		$^\circ\text{C/W}$	Junction to Cathode Lead
$V_F$	Forward Voltage	HER/Orange	1.5	1.9	2.4	V	$I_F = 10\text{ mA}$
		Yellow	1.5	2.0	2.4		
		Green	1.5	2.1	2.7		
		Emerald Green		2.1	2.7		
$V_R$	Reverse Breakdown Voltage	All	5.0			V	$I_R = 100\text{ }\mu\text{A}$
$\eta_V$	Luminous Efficacy	High Efficiency Red		145		lumens	See Note 3
		Orange		380		watt	
		Yellow		500			
		Green		595			
		Emerald Green		655			

### Notes:

- $\theta^{1/2}$  is the off-axis angle at which the luminous intensity is half the axial luminous intensity.
- The dominant wavelength,  $\lambda_d$ , is derived from the CIE chromaticity diagram and represents the single wavelength which defines the color of the device.
- Radiant intensity,  $I_e$ , in watts/steradian, may be found from the equation  $I_e = I_v/\eta_v$ , where  $I_v$  is the luminous intensity in candelas and  $\eta_v$  is the luminous efficacy in lumens/watt.

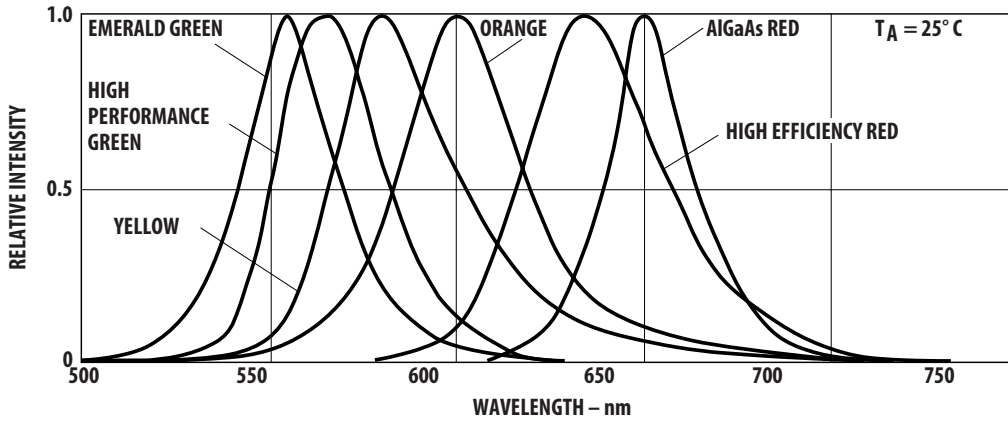

Figure 1. Relative intensity vs. wavelength

T-1 High Efficiency Red, Orange Diffused Lamps

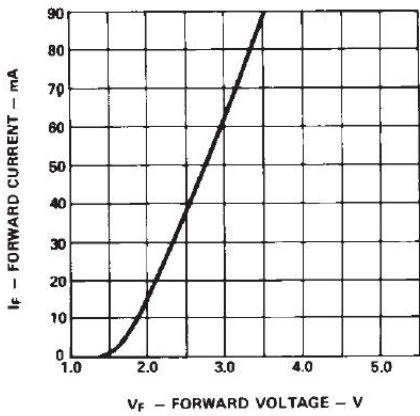

Figure 2. Forward current vs. forward voltage characteristics

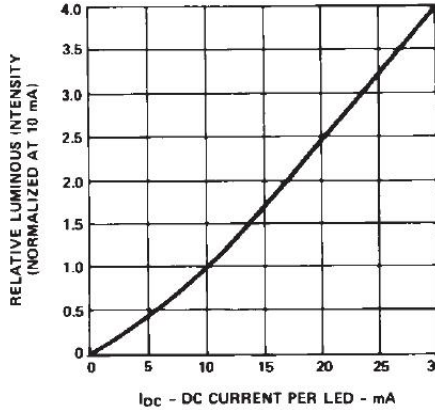

Figure 3. Relative luminous intensity vs. DC forward current

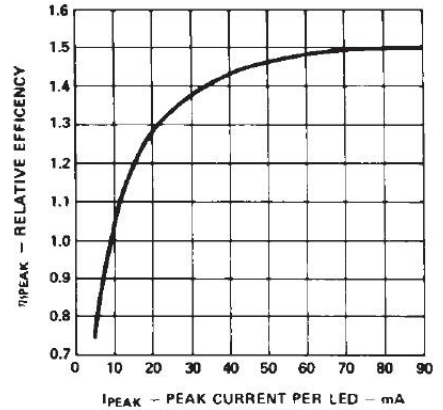

Figure 4. Relative efficiency (luminous intensity per unit current) vs. peak LED current

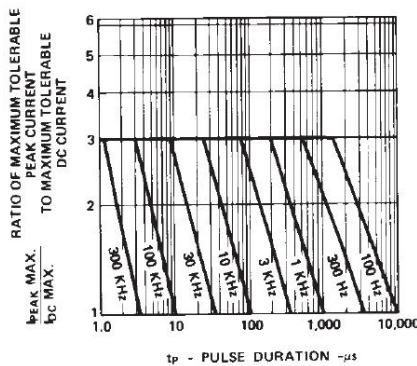

Figure 5. Maximum tolerable peak current vs. pulse duration. ( $I_{DC}$  MAX as per MAX ratings)

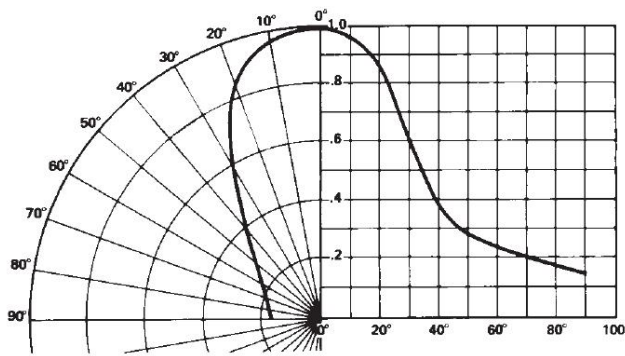

Figure 6. Relative luminous intensity vs. angular displacement

## T-1 Yellow Diffused Lamps

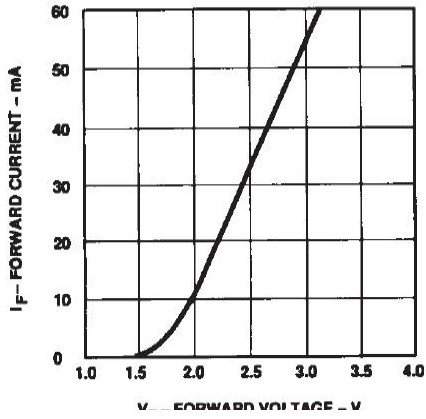

Figure 7. Forward current vs. forward voltage characteristics

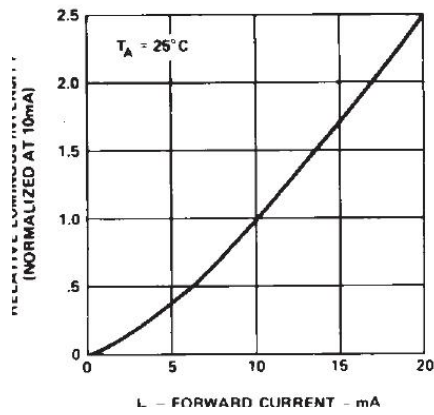

Figure 8. Relative luminous intensity vs. forward current

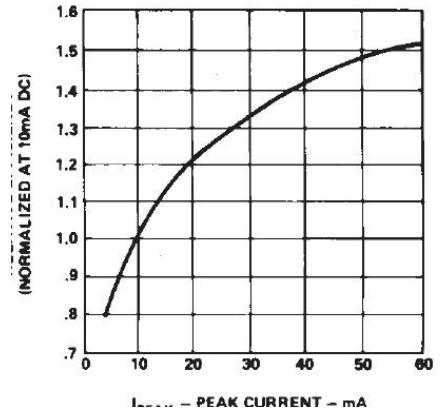

Figure 9. Relative efficiency (luminous intensity per unit current) vs. peak current

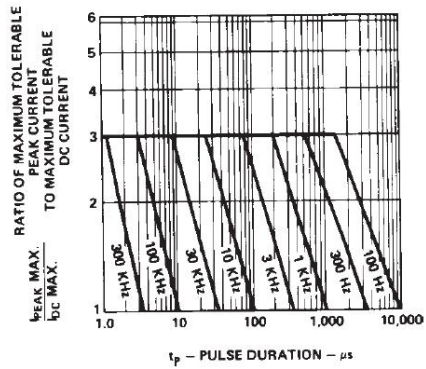

Figure 10. Maximum tolerable peak current vs. pulse duration. ( $I_{DC}$  MAX as per MAX ratings)

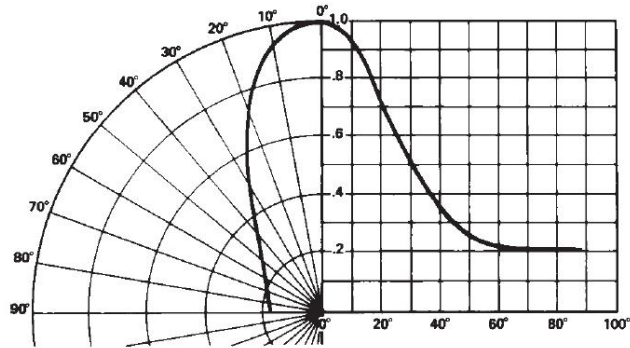

Figure 11. Relative luminous intensity vs. angular displacement

## T-1 Green/Emerald Green Diffused Lamps

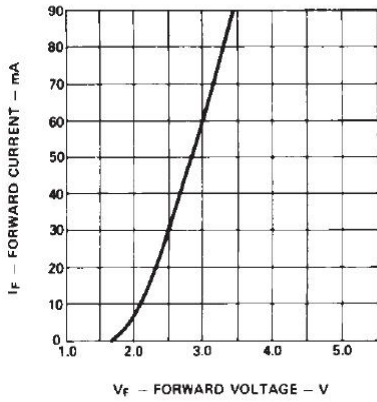

Figure 12. Forward current vs. forward voltage characteristics

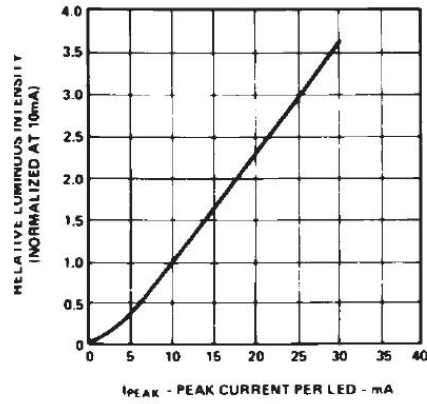

Figure 13. Relative luminous intensity vs. forward current

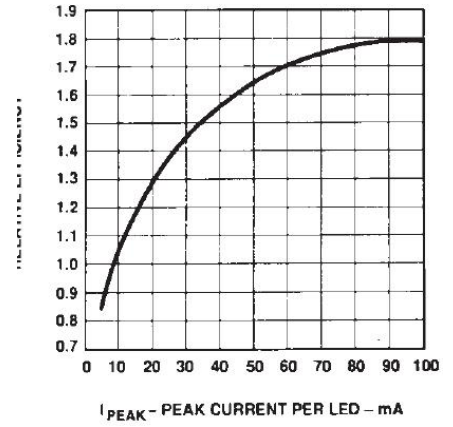

Figure 14. Relative efficiency (luminous intensity per unit current) vs. peak LED current

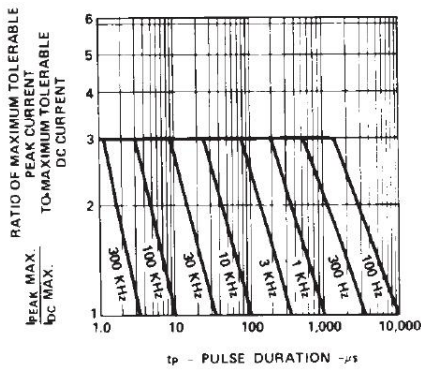

Figure 15. Maximum tolerable peak current vs. pulse duration. ( $I_{DC}$  MAX as per MAX ratings)

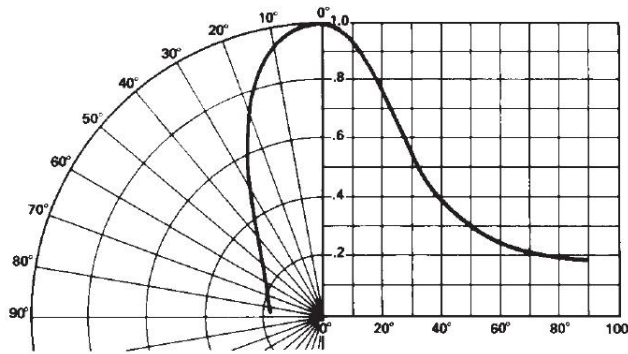

Figure 16. Relative luminous intensity vs. angular displacement



## Intensity Bin Limits

Color	Bin	Intensity Range (mcd)	
		Min.	Max.
Red/Orange	D	2.4	3.8
	E	3.8	6.1
	F	6.1	9.7
	G	9.7	15.5
	H	15.5	24.8
	I	24.8	39.6
	J	39.6	63.4
	K	63.4	101.5
	L	101.5	162.4
	M	162.4	234.6
	N	234.6	340.0
	O	340.0	540.0
	P	540.0	850.0
	Q	850.0	1200.0
	R	1200.0	1700.0
	S	1700.0	2400.0
	T	2400.0	3400.0
	U	3400.0	4900.0
	V	4900.0	7100.0
	W	7100.0	10200.0
X	10200.0	14800.0	
Y	14800.0	21400.0	
Z	21400.0	30900.0	
Yellow	C	2.5	4.0
	D	4.0	6.5
	E	6.5	10.3
	F	10.3	16.6
	G	16.6	26.5
	H	26.5	42.3
	I	42.3	67.7
	J	67.7	108.2
	K	108.2	173.2
	L	173.2	250.0
	M	250.0	360.0
	N	360.0	510.0
	O	510.0	800.0
	P	800.0	1250.0
	Q	1250.0	1800.0
	R	1800.0	2900.0
	S	2900.0	4700.0
T	4700.0	7200.0	
U	7200.0	11700.0	
V	11700.0	18000.0	
W	18000.0	27000.0	

**Intensity Bin Limits, continued**

Color	Bin	Intensity Range (mcd)	
		Min.	Max.
Green/ Emerald Green	A	1.1	1.8
	B	1.8	2.9
	C	2.9	4.7
	D	4.7	7.6
	E	7.6	12.0
	F	12.0	19.1
	G	19.1	30.7
	H	30.7	49.1
	I	49.1	78.5
	J	78.5	125.7
	K	125.7	201.1
	L	201.1	289.0
	M	289.0	417.0
	N	417.0	680.0
	O	680.0	1100.0
	P	1100.0	1800.0
	Q	1800.0	2700.0
	R	2700.0	4300.0
	S	4300.0	6800.0
T	6800.0	10800.0	
U	10800.0	16000.0	
V	16000.0	25000.0	
W	25000.0	40000.0	

Maximum tolerance for each bin limit is  $\pm 18\%$ .

## Color Categories

Color	Category #	Lambda (nm)	
		Min.	Max.
Emerald Green	9	522.5	555.5
	8	555.5	558.5
	7	558.5	561.5
	6	561.5	564.5
Green	6	561.5	564.5
	5	564.5	567.5
	4	567.5	570.5
	3	570.5	573.5
	2	573.5	576.5
Yellow	1	582.0	584.5
	3	584.5	587.0
	2	587.0	589.5
	4	589.5	592.0
	5	592.0	593.0
Orange	1	597.0	599.5
	2	599.5	602.0
	3	602.0	604.5
	4	604.5	607.5
	5	607.5	610.5
	6	610.5	613.5
	7	613.5	616.5
	8	616.5	619.5

Tolerance for each bin limit is  $\pm 0.5$  nm.

## Mechanical Option Matrix

<b>Mechanical Option Code</b>	<b>Definition</b>
00	Bulk Packaging, minimum increment 500 pcs/bag
01	Tape & Reel, crimped leads, minimum increment 1800 pcs/bag
02	Tape & Reel, straight leads, minimum increment 1800 pcs/bag
A1	Right Angle Housing, uneven leads, minimum increment 500 pcs/bag
A2	Right Angle Housing, even leads, minimum increment 500 pcs/bag
BG	Tape & Reel, straight leads in 2K increment
BJ	Tape & Reel, straight leads in 2K increment
DD	Ammo Pack, straight leads in 2K increment
DJ	Ammo Pack, straight leads in 2K increment
EE	Ammo Pack, straight leads in 5K increment
R4	Tape & Reel, straight leads, counter clockwise, anode lead leaving the reel first
VA	Ammo Pack, horizontal leads in 2K increment
VB	Ammo Pack, horizontal leads in 2K increment
FG	Inventory Control for Customer IDI

Note: All categories are established for classification of products. Products may not be available in all categories. Please contact your local Avago representative for further clarification or information.

## Precautions

### Lead Forming

- The leads of an LED lamp may be preformed or cut to length before they are inserted and soldered into the PC board.
- If forming a lead is required before it is soldered, then take care to avoid any excessive mechanical stress induced to the LED package. Otherwise, cut the LED leads to length after soldering at room temperature. The solder joint formed will absorb the mechanical stress of the lead cutting from traveling to the LED chip die attach and wirebond.
- It is recommended that tooling be made precisely and the leads cut to length, rather than relying on your hand.

### Soldering Conditions

- Care must be taken during PCB assembly and soldering process to prevent damage to LED component.
- The closest an LED is allowed to be soldered on board is 1.59 mm below the body (encapsulant epoxy) for those parts without standoff.
- Recommended soldering conditions:

	Wave Soldering	Manual Solder Dipping
Pre-heat Temperature	105 °C Max.	–
Pre-heat Time	30 sec Max.	–
Peak Temperature	250 °C Max.	260 °C Max.
Dwell Time	3 sec Max.	5 sec Max.

- The wave soldering parameter must be set and maintained according to the recommended temperature and dwell time in the solder wave. Customer is advised to periodically check the soldering profile to ensure the soldering profile used always conforms to recommended soldering condition.
- If necessary, use a fixture during soldering process to hold the LED component in the proper orientation with respect to the PCB.
- Proper handling is a must to avoid excessive thermal stresses to LED components when heated. Therefore, the soldered PCB must be allowed to cool to room temperature, 25 °C, before handling.
- To ensure solderability, pay special attention to board fabrication, solder masking, surface plating and lead hole size and component orientation.
- Here are the recommended PC board plated through-hole sizes for LED component leads:

	LED Component Lead Size	Diagonal	Plated Through-Hole Diameter
Lead size (typ.)	0.45 × 0.45 mm (0.018 × 0.018 in.)	0.636 mm (0.025 in)	0.98 to 1.08 mm (0.039 to 0.043 in)
Dambar shear-off area (max.)	0.65 mm (0.026 in)	0.919 mm (0.036 in)	
Lead size (typ.)	0.50 × 0.50 mm (0.020 × 0.020 in.)	0.707 mm (0.028 in)	1.05 to 1.15 mm (0.041 to 0.045 in)
Dambar shear-off area (max.)	0.70 mm (0.028 in)	0.99 mm (0.039 in)	

Note: Refer to application note AN1027 for more information on soldering LED components.

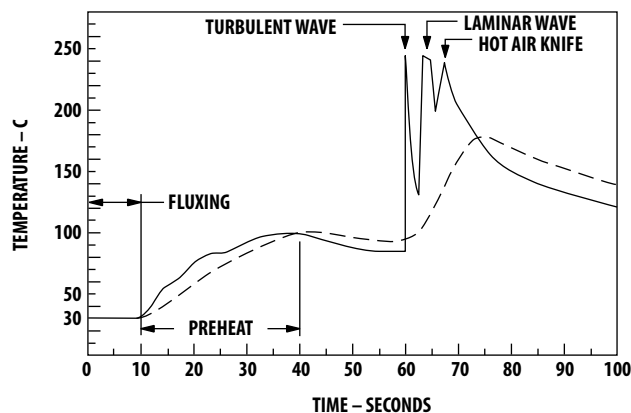

Figure 17. Recommended wave soldering profile

—	BOTTOM SIDE OF PCB BOARD
- - -	TOP SIDE OF PCB BOARD

CONVEYOR SPEED = 1.83 M/MIN (6 FT/MIN)  
 PREHEAT SETTING = 150C (100C PCB)  
 SOLDER WAVE TEMPERATURE = 245C  
 AIR KNIFE AIR TEMPERATURE = 390C  
 AIR KNIFE DISTANCE = 1.91 mm (0.25 IN.)  
 AIR KNIFE ANGLE = 40  
 SOLDER: SN63; FLUX: RMA

NOTE: ALLOW FOR BOARDS TO BE SUFFICIENTLY COOLED BEFORE EXERTING MECHANICAL FORCE.

For product information and a complete list of distributors, please go to our web site: [www.avagotech.com](http://www.avagotech.com)

Avago, Avago Technologies, and the A logo are trademarks of Avago Technologies in the United States and other countries. Data subject to change. Copyright © 2005-2013 Avago Technologies. All rights reserved. Obsoletes 5989-4252EN AV02-1555EN - March 26, 2013

**AVAGO**  
TECHNOLOGIES

## Данный компонент на территории Российской Федерации

### Вы можете приобрести в компании MosChip.

Для оперативного оформления запроса Вам необходимо перейти по данной ссылке:

<http://moschip.ru/get-element>

Вы можете разместить у нас заказ для любого Вашего проекта, будь то серийное производство или разработка единичного прибора.

В нашем ассортименте представлены ведущие мировые производители активных и пассивных электронных компонентов.

Нашей специализацией является поставка электронной компонентной базы двойного назначения, продукции таких производителей как XILINX, Intel (ex.ALTERA), Vicor, Microchip, Texas Instruments, Analog Devices, Mini-Circuits, Amphenol, Glenair.

Сотрудничество с глобальными дистрибьюторами электронных компонентов, предоставляет возможность заказывать и получать с международных складов практически любой перечень компонентов в оптимальные для Вас сроки.

На всех этапах разработки и производства наши партнеры могут получить квалифицированную поддержку опытных инженеров.

Система менеджмента качества компании отвечает требованиям в соответствии с ГОСТ Р ИСО 9001, ГОСТ РВ 0015-002 и ЭС РД 009

### Офис по работе с юридическими лицами:

105318, г.Москва, ул.Щербаковская д.3, офис 1107, 1118, ДЦ «Щербаковский»

Телефон: +7 495 668-12-70 (многоканальный)

Факс: +7 495 668-12-70 (доб.304)

E-mail: [info@moschip.ru](mailto:info@moschip.ru)

Skype отдела продаж:

moschip.ru

moschip.ru\_4

moschip.ru\_6

moschip.ru\_9