

## 10A, 600V - 1000V Glass Passivated Single-Phase Bridge Rectifiers

### FEATURES

- Thin Single in-line low profile package ideal for compact required circuit
- Glass passivated junction
- High surge current capability
- UL Recognized File # E-326243
- Compliant to RoHS Directive 2011/65/EU and in accordance to WEEE 2002/96/EC
- Halogen-free according to IEC 61249-2-21



### MECHANICAL DATA

**Case:** KBJL

Molding compound, UL flammability classification rating 94V-0

Part no. with suffix "H" means AEC-Q101 qualified

Packing code with suffix "G" means green compound (halogen-free)

**Terminal:** Matte tin plated leads, solderable per JESD22-B102

Meet JESD 201 class 2 whisker test

**Polarity:** As marked

**Mounting torque:** 0.56 Nm max. (5 in-lbs. max.)

**Weight:** 2.5g (approximately)

**KBJL**

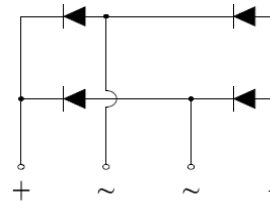

MAXIMUM RATINGS AND ELECTRICAL CHARACTERISTICS (T <sub>J</sub> =25°C unless otherwise noted)					
PARAMETER	SYMBOL	TS10KL60	TS10KL80	TS10KL100	UNIT
Maximum repetitive peak reverse voltage	V <sub>RRM</sub>	600	800	1000	V
Maximum RMS voltage	V <sub>RMS</sub>	420	560	700	V
Maximum DC blocking voltage	V <sub>DC</sub>	600	800	1000	V
Maximum average forward rectified current	I <sub>F(AV)</sub>	10			A
Peak forward surge current, 8.3 ms single half sine-wave superimposed on rated load	I <sub>FSM</sub>	180			A
Rating of fusing ( t<8.3ms)	I <sup>2</sup> t	134			A <sup>2</sup> s
Maximum instantaneous forward voltage (Note 1) I <sub>F</sub> = 5 A	V <sub>F</sub>	1.0			V
Maximum reverse current @ rated V <sub>R</sub> T <sub>J</sub> =25 °C T <sub>J</sub> =100 °C	I <sub>R</sub>	5 150			μA
Typical thermal resistance (Note 2)	R <sub>θJC</sub>	1.5			°C/W
Operating junction temperature range	T <sub>J</sub>	- 55 to +150			°C
Storage temperature range	T <sub>STG</sub>	- 55 to +150			°C

Note 1: Pulse test with PW=300 μs, 1% duty cycle

Note 2: Mount on Heatsink size of 4" x 6" x 0.25" Al-Plate

**ORDERING INFORMATION**

PART NO.	PART NO. SUFFIX	PACKING CODE	PACKING CODE SUFFIX (*)	PACKAGE	PACKING
TS10KLXX (Note 1)	H	D3	G	KBJL	20 / TUBE

Note 1: "xx" defines voltage from 600V (TS10KL60) to 1000V (TS10KL100)

\*: Optional available

**EXAMPLE**

PREFERRED P/N	PART NO.	PART NO. SUFFIX	PACKING CODE	PACKING CODE SUFFIX	DESCRIPTION
TS10KL80HD3G	TS10KL80	H	D3	G	AEC-Q101 qualified Green compound

**RATINGS AND CHARACTERISTICS CURVES**

(T<sub>A</sub>=25°C unless otherwise noted)

FIG.1 FORWARD CURRENT DERATING CURVE

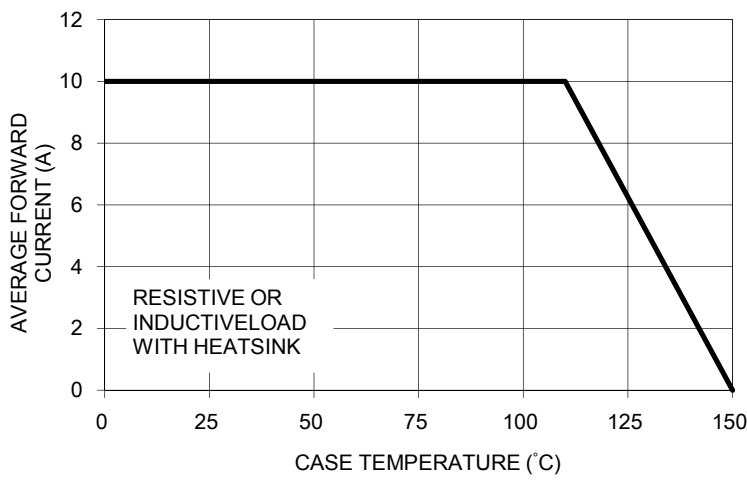

FIG. 2 MAXIMUM NON-REPETITIVE FORWARD SURGE CURRENT

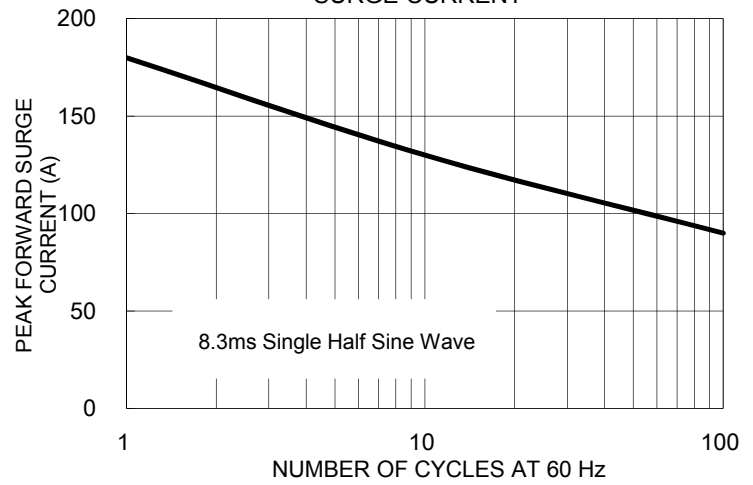

FIG. 3 TYPICAL FORWARD CHARACTERISTICS

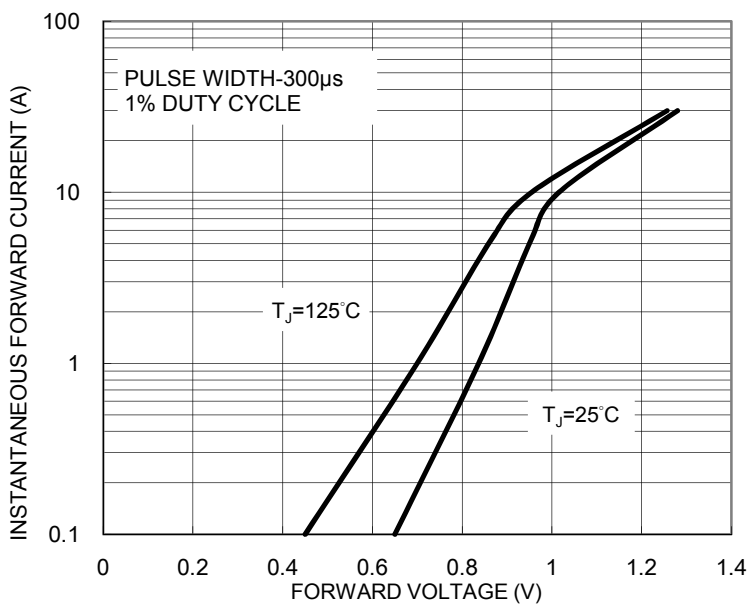

FIG. 4 TYPICAL REVERSE CHARACTERISTICS

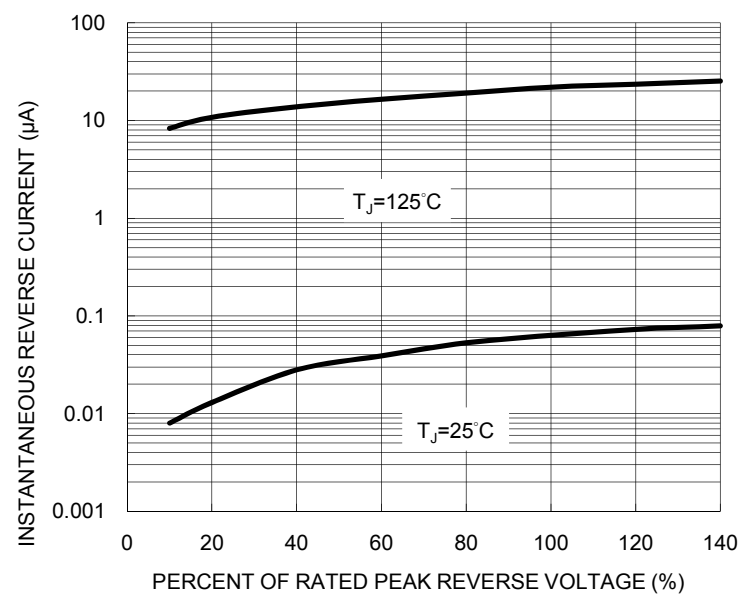
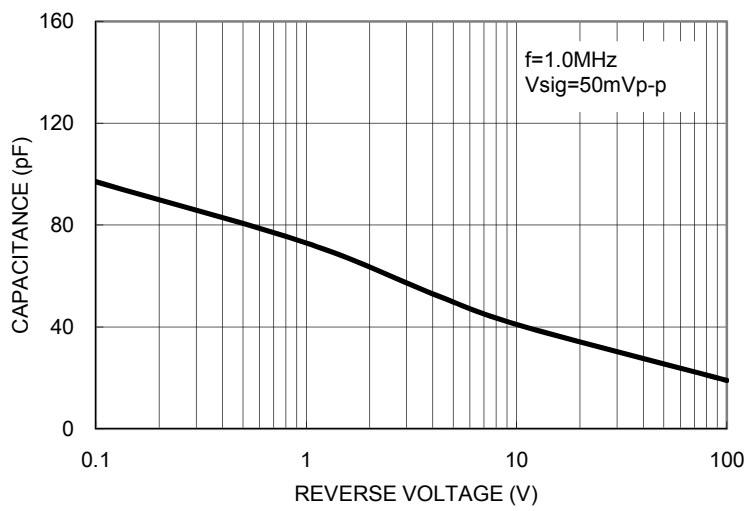
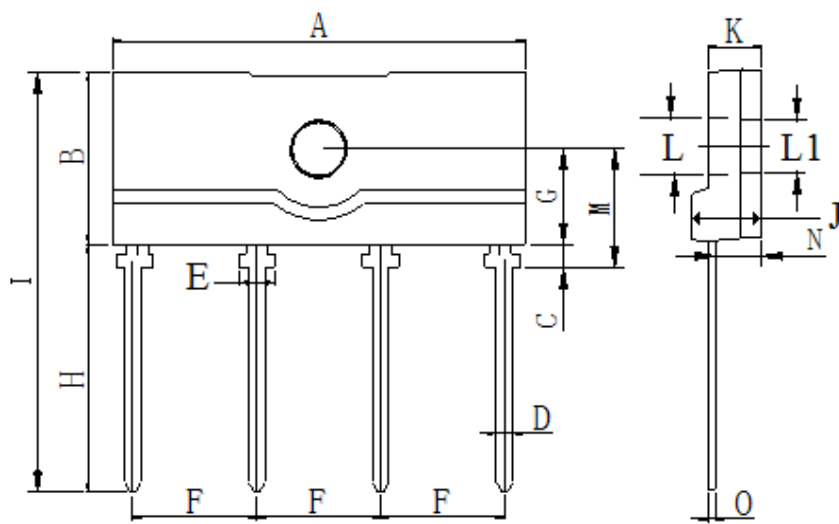

FIG. 5 TYPICAL JUNCTION CAPACITANCE



PACKAGE OUTLINE DIMENSIONS

**KBJL**



DIM.	Unit (mm)		Unit (inch)	
	Min	Max	Min	Max
A	24.70	25.30	0.972	0.996
B	10.00	10.60	0.394	0.417
C	1.20	1.60	0.047	0.063
D	0.90	1.10	0.035	0.043
E	2.10	2.30	0.083	0.091
F	7.30	7.70	0.287	0.303
G	5.50	5.90	0.217	0.232
H	14.40	15.40	0.567	0.606
I	24.90	25.50	0.980	1.004
J	4.00	4.40	0.157	0.173
K	3.00	3.40	0.118	0.134
L	3.30	3.50	0.130	0.138
L1	3.10	3.30	0.122	0.130
M	6.90	7.30	0.272	0.287
N	2.50	2.90	0.098	0.114
O	0.30	0.70	0.012	0.028

MARKING DIAGRAM

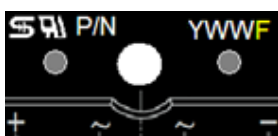

P/N = Specific Device Code  
 YWW = Date Code  
 F = Factory Code

## Notice

Specifications of the products displayed herein are subject to change without notice. TSC or anyone on its behalf, assumes no responsibility or liability for any errors or inaccuracies.

Information contained herein is intended to provide a product description only. No license, express or implied, to any intellectual property rights is granted by this document. Except as provided in TSC's terms and conditions of sale for such products, TSC assumes no liability whatsoever, and disclaims any express or implied warranty, relating to sale and/or use of TSC products including liability or warranties relating to fitness for a particular purpose, merchantability, or infringement of any patent, copyright, or other intellectual property right.

The products shown herein are not designed for use in medical, life-saving, or life-sustaining applications. Customers using or selling these products for use in such applications do so at their own risk and agree to fully indemnify TSC for any damages resulting from such improper use or sale.

## Данный компонент на территории Российской Федерации

### Вы можете приобрести в компании MosChip.

Для оперативного оформления запроса Вам необходимо перейти по данной ссылке:

<http://moschip.ru/get-element>

Вы можете разместить у нас заказ для любого Вашего проекта, будь то серийное производство или разработка единичного прибора.

В нашем ассортименте представлены ведущие мировые производители активных и пассивных электронных компонентов.

Нашей специализацией является поставка электронной компонентной базы двойного назначения, продукции таких производителей как XILINX, Intel (ex.ALTERA), Vicor, Microchip, Texas Instruments, Analog Devices, Mini-Circuits, Amphenol, Glenair.

Сотрудничество с глобальными дистрибьюторами электронных компонентов, предоставляет возможность заказывать и получать с международных складов практически любой перечень компонентов в оптимальные для Вас сроки.

На всех этапах разработки и производства наши партнеры могут получить квалифицированную поддержку опытных инженеров.

Система менеджмента качества компании отвечает требованиям в соответствии с ГОСТ Р ИСО 9001, ГОСТ РВ 0015-002 и ЭС РД 009

### Офис по работе с юридическими лицами:

105318, г.Москва, ул.Щербаковская д.3, офис 1107, 1118, ДЦ «Щербаковский»

Телефон: +7 495 668-12-70 (многоканальный)

Факс: +7 495 668-12-70 (доб.304)

E-mail: [info@moschip.ru](mailto:info@moschip.ru)

Skype отдела продаж:

moschip.ru

moschip.ru\_4

moschip.ru\_6

moschip.ru\_9