

# Easy-wire connectors for Industrial Components

# XN2

## Easy-wire Connectors with *e-CON*\* Specifications; Ideal for Connecting Sensors.

- Uses industry-proven spring clamps for wiring.
- No special tools required for easy wiring.
- Easy to rewire and repair
- Each Connector accepts any wire size from AWG28 (0.08 mm<sup>2</sup>) to AWG20 (0.5 mm<sup>2</sup>). (External sheath diameter: 1.5 mm max.)
- RoHS Compliant

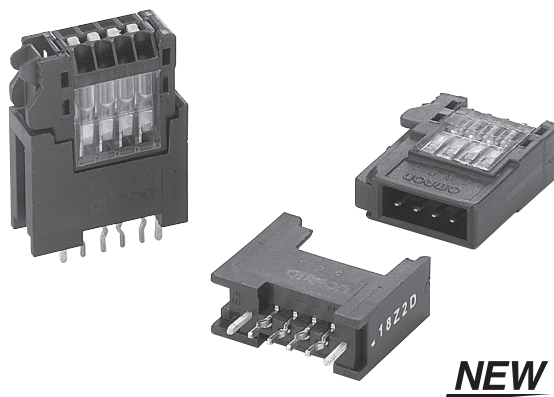

\*E-con specifications are currently being promoted for standardization by manufacturers of FA components and connectors.

## Wiring Configuration Example

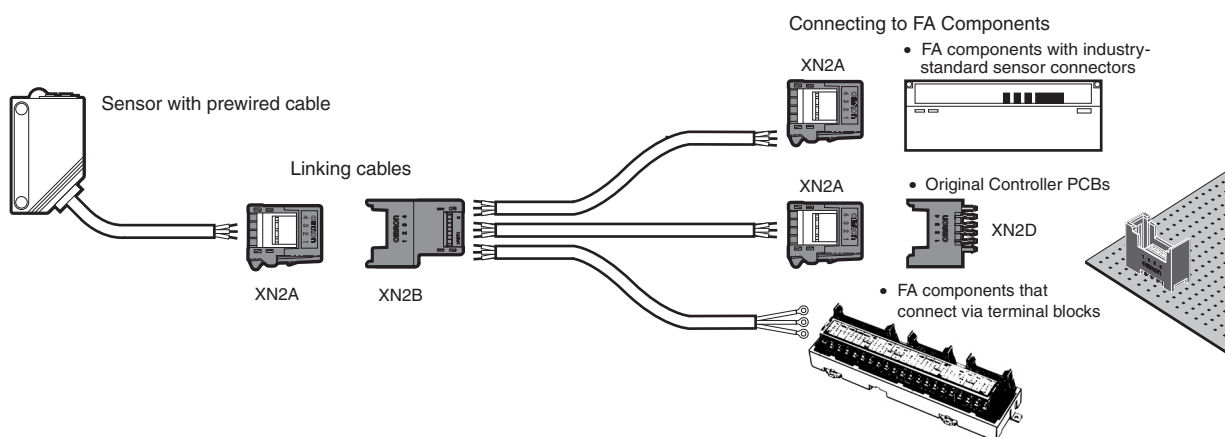

## Ordering Information

| Type            | Cable Plug Connector | Cable Socket Connector | Single-socket PCB Socket Connector | Four-socket PCB Socket Connector |
|-----------------|----------------------|------------------------|------------------------------------|----------------------------------|
| Appearance      |                      |                        |                                    |                                  |
| No. of contacts | Model                | Model                  | Model                              | Model                            |
| 3               | XN2A-1370            | ---                    | XN2D-1371                          | ---                              |
| 4               | XN2A-1470            | XN2B-1470              | XN2D-1471                          | XN2D-4471                        |
| 5               | XN2A-1570            | ---                    | XN2D-1571                          | ---                              |
| 6               | XN2A-1670            | ---                    | XN2D-1671                          | ---                              |
| 8               | XN2A-1870            | ---                    | XN2D-1871                          | ---                              |

# Ratings and Specifications

|                                   |   |
|-----------------------------------|---|
| Rated current                     | 3 A/pole, using AWG20 (0.5 mm <sup>2</sup> ) wire<br>2 A/pole, using AWG22 (0.3 mm <sup>2</sup> ) wire<br>1 A/pole, using AWG24 (0.2 mm <sup>2</sup> ) wire<br>0.5 A/pole, using AWG26 (0.1 mm <sup>2</sup> ) or AWG28 (0.08 mm <sup>2</sup> ) wire |
| Rated voltage                     | 32 VDC  |
| Contact resistance (See note 1.)  | 30 mΩ max. (20 mVDC max., 100 mA max.)  |
| Insulation resistance             | 1,000 MΩ min. (at 500 VDC)  |
| Dielectric strength               | 1,000 VAC for 60 s (leakage current: 1 mA max.)   |
| Insertion tolerance               | 50 times  |
| Ambient temperature (See note 2.) | Operating: -30°C to 75°C  |
| Applicable wires (See note 3.)    | 0.08 mm <sup>2</sup> (AWG28) to 0.5mm <sup>2</sup> (AWG20)<br>The external diameter of the cable sheath is 1.5 mm max.  |

- Note:**
1. This value is the contact resistance of the connector.
  2. The temperature is limited, however, to the maximum operating temperature for the cables.
  3. Avoid using wires with a single strand diameter of 0.16 mm or smaller.

# Materials and Finish

| Item           | Cable Types  | PCB Types                                 |
|----------------|--|---|
| Housing        | Black PBT resin (UL94V-0)  |   |
| Cover          | Black PBT resin (UL94V-0)  | ---                                       |
| Base           | Transparent PC resin (UL94V-0)   | ---                                       |
| Lever          | PA resin (UL94V-0)/natural (white)   | ---                                       |
| Contact        | Phosphor bronze/Underplating: Nickel (1.5 to 3.0 μm)<br>Contacts: Gold (0.2 μm min.)<br>Terminals: Tin plating (1.0 μm min.) |   |
| Spring         | Stainless steel  | ---                                       |
| Fastening pins | ---  | Copper alloy/nickel base with tin plating |

# Dimensions (Unit: mm)

## Cable Plug Connector XN2A-1□70

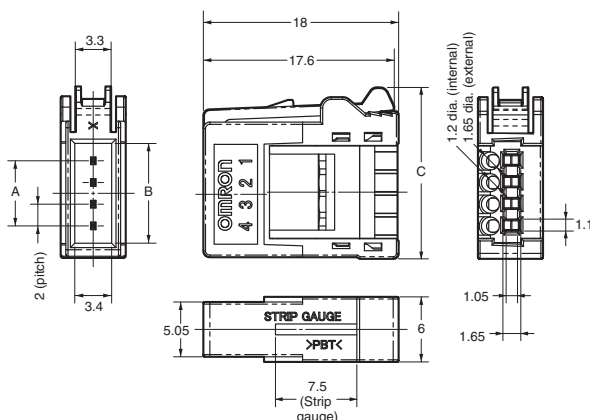

### Dimensions

| Dimension (mm)  | A    | B    | C    |
|-----------------|------|------|------|
| No. of contacts |      |      |      |
| 3               | 4.0  | 7.2  | 13.8 |
| 4               | 6.0  | 9.2  | 15.8 |
| 5               | 8.0  | 11.2 | 17.8 |
| 6               | 10.0 | 13.2 | 19.8 |
| 8               | 14.0 | 17.2 | 23.8 |

**Cable Socket Connector**  
XN2B-1470

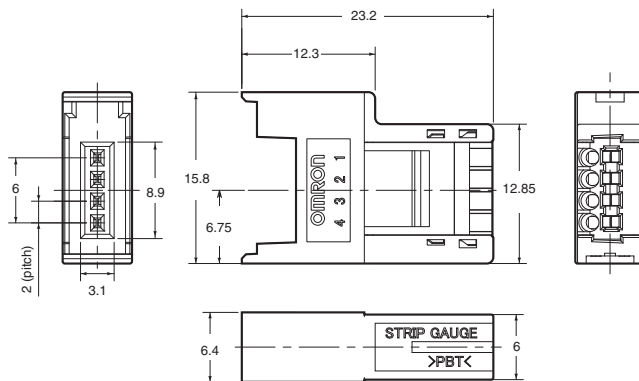

**Single-socket PCB Socket Connector**  
XN2D-1□71

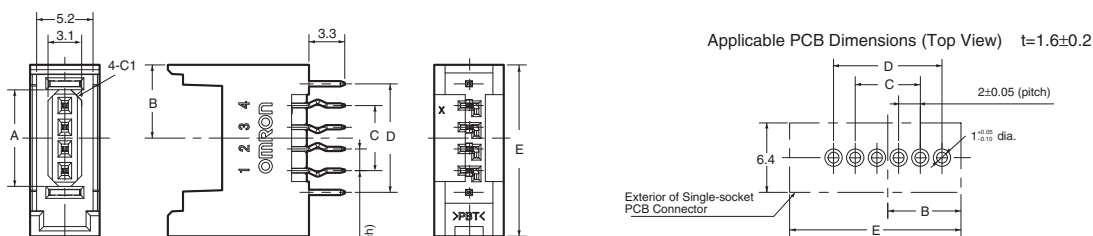

**Dimensions**

| Dimension (mm)         | A    | B    | C    | D    | E    |
|------------------------|------|------|------|------|------|
| <b>No. of contacts</b> |      |      |      |      |      |
| 3                      | 6.9  | 5.8  | 4.0  | 8.0  | 13.8 |
| 4                      | 8.9  | 6.8  | 6.0  | 10.0 | 15.8 |
| 5                      | 10.9 | 7.8  | 8.0  | 12.0 | 17.8 |
| 6                      | 12.9 | 8.8  | 10.0 | 14.0 | 19.8 |
| 8                      | 16.9 | 10.8 | 14.0 | 18.0 | 23.8 |

**Four-socket PCB Socket Connector**  
XN2D-4471

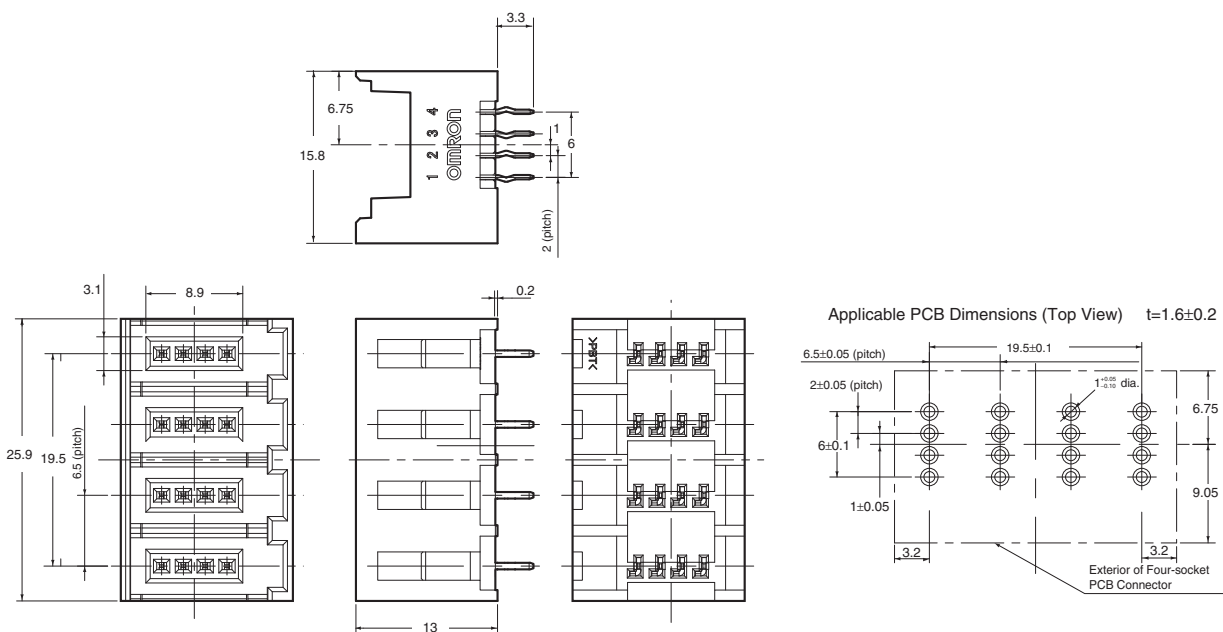

# Assembly Instructions

## Preparing the Cable

Align the cable with the guide marked STRIP GAUGE on the side of the Connector, strip 7 to 8 mm of the cable sheath, and then twist the wires several times.

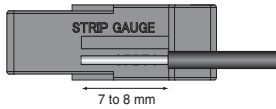

## Connecting the Cable to the Connector

1. Use a flat-blade screwdriver to push down the operating lever inside the operation slot until it locks.

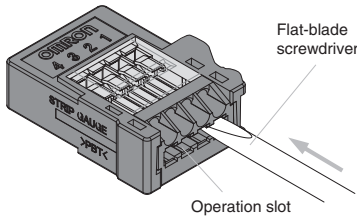

2. Insert the wire fully to the back of the wire insertion hole. Make sure that the cable sheath is inserted into the hole, and that the end of the wire has passed through the contact section.

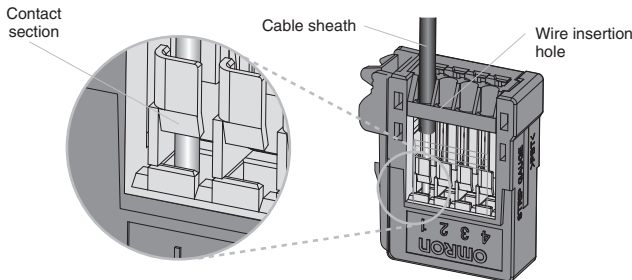

3. Insert the screwdriver into the release slot, and gently pull back the lever until a click is heard by resetting the lever.

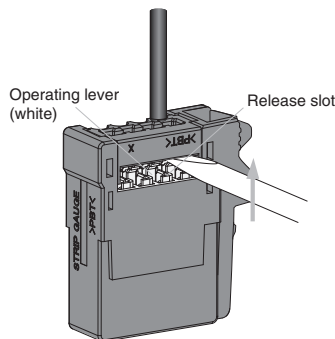

4. Make sure that the following operations have been performed.

- Check that the operating lever is reset.
- Check that the procedure in step 2 has been followed. (Pull gently on the cable to make sure that there is resistance, indicating that the Connectors are wired correctly.)

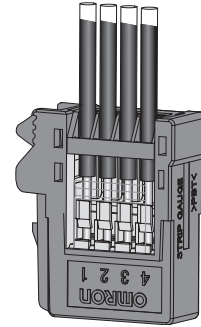

## Removing Cables from the Connector

1. Press down on the operating lever to lock the lever before removing the cable.

2. After removing the cable from the Connector, always reset the operating lever, except when rewiring the Connector. The Connector can be rewired without resetting the operating lever.

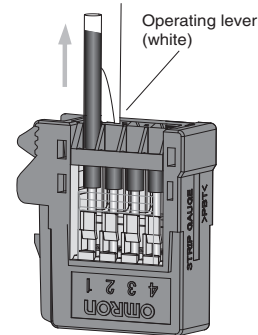

# Safety Precautions

---

## ■ General Precautions

- Do not pull on the Connectors or cables. Doing so may cause damage to the Connectors or cause the cables to disconnect.
- Install the Connectors in a location where they will not be stepped on, to prevent disconnection of the cables or damage to the Connectors. If the Connectors have to be installed in such a location, use a protective cover.
- Make sure that the Connectors are mated in the correct direction. Mating the Connectors incorrectly will damage to the Connectors.
- Do not use the Connectors if the lock lever is bent or broken. Doing so may cause the Connector to become loose or the device to malfunction.
- Before mounting Connectors to a PCB, make sure that the Connectors are positioned in the correct direction.
- Before bending a cable to connect it to a Connector, check the bending specifications of the cable to be used.
- Do not exceed the rated current of the cable. Always check the rated current of each cable to be used.
- Do not use pliers or other tools to remove the Connectors.
- Hold the Connectors firmly by hand when handling them. Do not use excessive force to push the Connectors. Forcing the Connectors may result in injury.
- These Connectors do not resist water. Do not use Connectors in places where water or oil may be sprayed onto the Connectors.

## ■ Precautions for Correct Use

### Wiring

- Insert one wire into each insertion hole. Inserting two or more wires into a single hole may cause unexpected problems.
- Make sure that no power is being supplied to a Connector before wiring, inserting, or removing the Connector. Doing so may result in electric shock.
- Follow the wiring diagrams for the device being used when wiring the cables.
- Strip the cables according to the instructions in the applicable operation manual, making sure not to damage the wires.
- Do not use a screwdriver with a tip larger than the specified width when wiring the Connectors.
- Make sure short-circuits are not created, e.g., by protruding wires.

### Inserting and Removing Connectors

- When connecting or disconnecting Connectors, always hold the case of the Connector.
- When mating Connectors, insert the Connector fully into the back of the socket, and then make sure that the Connector will not become loose by lightly pulling it in the opposite direction.

### Recommended Screwdriver

- Use a flat-blade screwdriver with a tip of 2 mm max. Do not use screwdrivers that gradually widen towards the base of the screwdriver.
- Using other screwdrivers may cause damage to the adjacent poles.

All sales are subject to Omron Electronic Components LLC standard terms and conditions of sale, which can be found at [http://www.components.omron.com/components/web/webfiles.nsf/sales\\_terms.html](http://www.components.omron.com/components/web/webfiles.nsf/sales_terms.html)

**ALL DIMENSIONS SHOWN ARE IN MILLIMETERS.**  
To convert millimeters into inches, multiply by 0.03937. To convert grams into ounces, multiply by 0.03527.

---

**OMRON**<sup>®</sup>

**OMRON ELECTRONIC  
COMPONENTS LLC**

55 E. Commerce Drive, Suite B  
Schaumburg, IL 60173

**847-882-2288**

**OMRON ON-LINE**

Global - <http://www.omron.com>

USA - <http://www.components.omron.com>

## Данный компонент на территории Российской Федерации

### Вы можете приобрести в компании MosChip.

Для оперативного оформления запроса Вам необходимо перейти по данной ссылке:

<http://moschip.ru/get-element>

Вы можете разместить у нас заказ для любого Вашего проекта, будь то серийное производство или разработка единичного прибора.

В нашем ассортименте представлены ведущие мировые производители активных и пассивных электронных компонентов.

Нашей специализацией является поставка электронной компонентной базы двойного назначения, продукции таких производителей как XILINX, Intel (ex.ALTERA), Vicor, Microchip, Texas Instruments, Analog Devices, Mini-Circuits, Amphenol, Glenair.

Сотрудничество с глобальными дистрибьюторами электронных компонентов, предоставляет возможность заказывать и получать с международных складов практически любой перечень компонентов в оптимальные для Вас сроки.

На всех этапах разработки и производства наши партнеры могут получить квалифицированную поддержку опытных инженеров.

Система менеджмента качества компании отвечает требованиям в соответствии с ГОСТ Р ИСО 9001, ГОСТ РВ 0015-002 и ЭС РД 009

### Офис по работе с юридическими лицами:

105318, г.Москва, ул.Щербаковская д.3, офис 1107, 1118, ДЦ «Щербаковский»

Телефон: +7 495 668-12-70 (многоканальный)

Факс: +7 495 668-12-70 (доб.304)

E-mail: [info@moschip.ru](mailto:info@moschip.ru)

Skype отдела продаж:

moschip.ru

moschip.ru\_4

moschip.ru\_6

moschip.ru\_9